

THE VORTEX

SLIDE OWNER'S MANUAL



**CORPORATE HEADQUARTERS
WESTERN SALES AND MANUFACTURING PLANT
P.O. Box 400 • 1017 SW Berg Parkway
Canby, Oregon 97013
Phone: (503) 266-2231 • Fax: (503) 266-4334
www.srsmith.com**

Table of Contents

<u>Topic</u>	<u>Page #</u>
Introduction.....	2
Applicable Standards and Codes.....	2
Assembly & Installation.....	2
Drawings.....	2
Subsequent Owners.....	2
Manufacturer's Placement Instructions.....	3
Installed Slide's Structural & Installation Checklist.....	5
Intended Use Instructions.....	5
Sitting Slide Position.....	6
Do Not Slide Head First.....	7
Daily/Weekly Maintenance Of Slide.....	7
Cleaning Instructions.....	8

INTRODUCTION

S.R. SMITH VORTEX SLIDES ARE DESIGNED AND MANUFACTURED FOR INSTALLATION AND USE ON IN GROUND SWIMMING POOLS ONLY. S.R. SMITH VORTEX SLIDES ARE NEVER TO BE INSTALLED AND USED ON HOUSEBOATS, BOAT DOCKS, FLOATING DOCKS OR PLATFORMS, OR OTHER BODIES OF WATER SUCH AS LAKES, PONDS, RIVERS, ETC. PROPER AND COMPLETE ASSEMBLY, USE AND SUPERVISION IS ESSENTIAL FOR PROPER OPERATION AND TO REDUCE THE RISK OF ACCIDENT OR INJURY.

APPLICABLE STANDARDS AND CODES

The installation of the Vortex must comply with all applicable governmental and building codes.

ASSEMBLY AND INSTALLATION

All S.R. Smith Vortex slides are inspected prior to shipment from the factory. Proper assembly and installation is mandatory. Improper assembly and installation voids S.R. Smith's warranty and may affect the safety of the user. S.R. Smith cannot and does not guarantee customer's deck.

DRAWINGS

All drawings in this Slide Owner's Manual (**FIG.'S 1** through **6**) are for illustration purposes only and are NOT TO SCALE.

SUBSEQUENT OWNERS

The Owner's Manual must remain with the owner of the slide. If the owner changes, the Owner's Manual shall be brought to the attention of the new owner.

MANUFACTURER'S PLACEMENT INSTRUCTIONS

The Vortex owner must confirm that the Manufacturer's Placement Instructions have been followed by the Installer.

1. The critical dimensions for placement of the Vortex are as shown in FIG.'S 1 and 2.

- A. The slide exit runway surface shall not exceed twenty inches (20") above the water surface as shown in **FIG.1**.
- B. The slide shall be positioned so that all water flowing off the runway exit drops into the pool. Recommended overhang is (3") inches.
- C. The minimum depth of water below the exit lip of the slide shall be three feet (3') and increases to four feet six inches (4'-6") at Pt. A, which is a distance of four feet six inches (4'-6") from the exit lip of the slide as shown in **FIG.1**.
- D. A minimum depth of four feet six inches (4'-6") shall be maintained at a distance of nine feet (9') along the extended centerline of the slide from Pt. A. as shown in **FIG.1**.

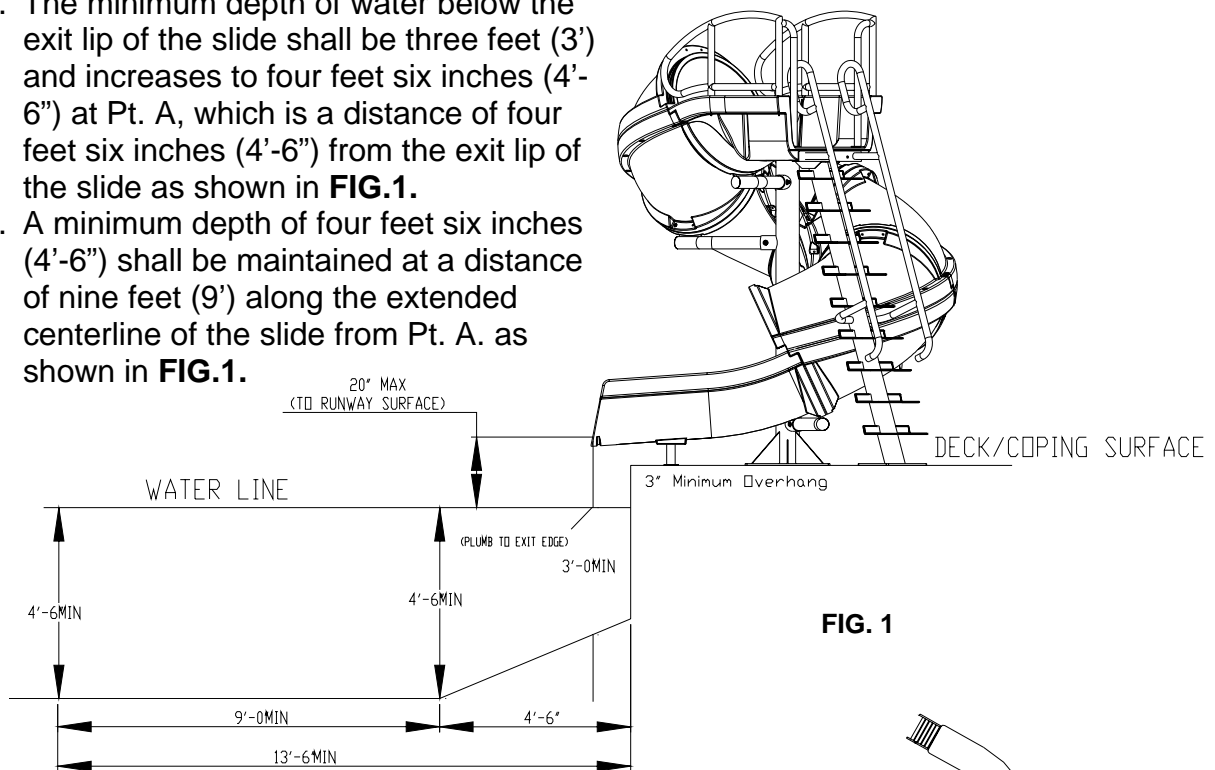

FIG. 1

2. A minimum clearance area in front of the slide shall be maintained at all times as follows:

- A. The minimum clearance distance on either side of the extended centerline of the slide runway shall not be less than three feet six inches (3'-6") at a point no less than two feet six inches (2'-6") from the exit lip of the slide and extending a distance of thirteen feet six inches (13'-6") in front of the slide as shown in **FIG.2**.

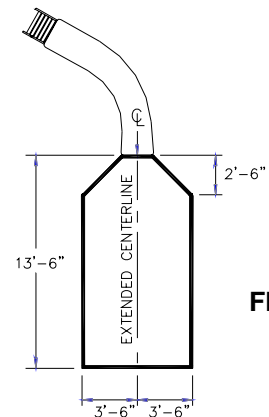

FIG. 2

SLIDE
MINIMUM CLEARANCE AREA

B. The minimum clearance area in front of a properly installed diving board on an inground swimming pool is a minimum distance of three feet six inches (3'-6")

on either side of the board's centerline as shown in **FIG. 3**. Pt. C extends a minimum distance of "C" from the tip end of the board as shown in **FIG.3**. The width distance "W" on either side of Pt. C is given in **CHART 1** and shown in **FIG.3**.

CHART 1

BOARD MINIMUM CLEARANCE AREA		
POOL TYPE	"C" DIMENSION	"W" DIMENSION
I	14'-6"	5'-0"
II	14'-6"	6'-0"
III	16'-6"	6'-0"
IV	18'-6"	7'-6"
V	21'-0"	7'-6"

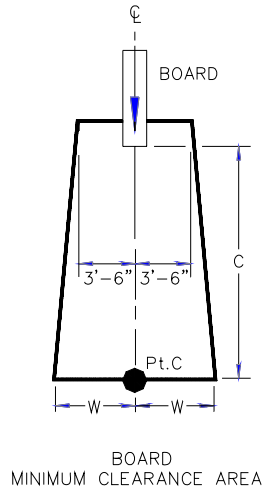

See Article 5 contained in ANSI/NSPI-5 2003 STANDARD FOR RESIDENTIAL INGROUND SWIMMING POOLS and refer to FIGURE 3 and Table 1 for Minimum Water Envelope Dimensions AB, BC and Width at Point C.

"C" DIMENSION FOR BOARD = AB + BC

"W" DIMENSION FOR BOARD = WIDTH AT PT.C

FIG. 3

C. The minimum clearance area of a slide or diving board shall not intersect any coping or rope and float line as shown in **FIG.4**. The minimum clearance area of a slide or diving board may intersect each other provided that they are not used simultaneously.

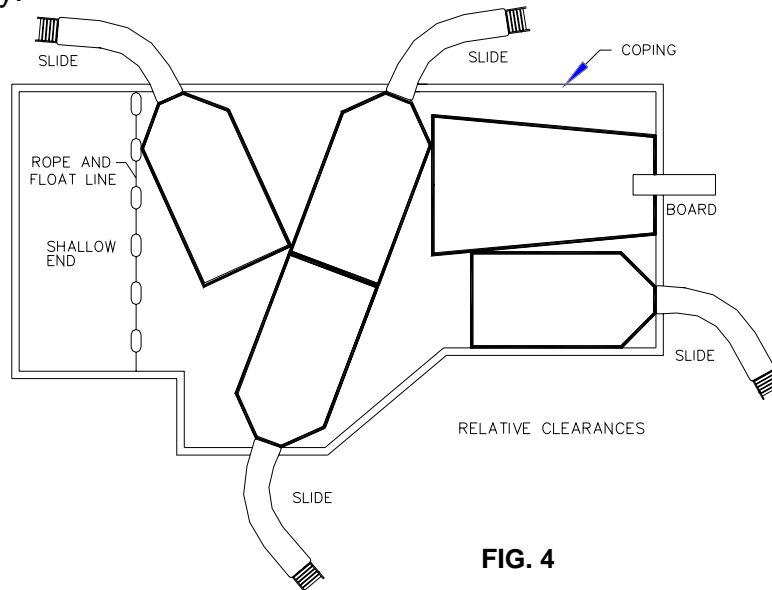
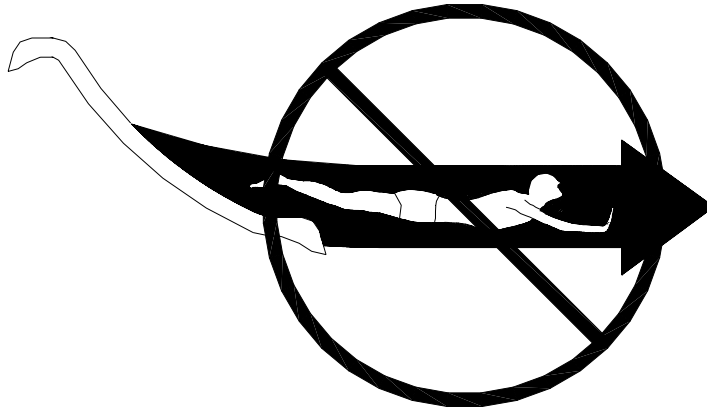

FIG. 4

INSTALLED VORTEX STRUCTURAL & INSTALLATION CHECKLIST



DO NOT SLIDE HEAD FIRST

After installation and prior to the first use of the Vortex and periodically (see DAILY/WEEKLY MAINTENANCE OF THE VORTEX) thereafter the owner must:

1. Inspect the runway for visible cracks or tears.
2. Inspect the ladder for sharp edges, protrusions, cracks or tears.
3. Inspect ladder and pedestal mounting areas for loose or corroded fasteners.
4. Measure the following dimensions and compare with the Manufacturer's Placement Instructions on pages 3 and 4.
 - Measure the depth of water in front of the slide exit. (4'-6") min. depth at a distance of (4'-6") from exit end of slide.
 - Measure the height of the slide runway exit above the water. (20" max.)
 - Measure the distance between the slide centerline and the edge of other pool equipment.
5. Observe the position of the exit of the slide as shown in **FIG.'S 1, 2 and 4** on pages 3 and 4.
6. Read, understand and enforce all safety and use instructions on the slide.

INTENDED USE INSTRUCTIONS

**** IMPORTANT ****

READ AND FOLLOW THE SIMPLE SAFETY RULES BELOW.

MAKE SURE THAT EVERYONE WHO USES THE VORTEX™ KNOWS AND FOLLOWS THESE RULES.

ENFORCE THESE RULES WITH ADULT SUPERVISION

Installed and used properly, the Vortex will give you, your family, friends and guests many hours of enjoyment. Like any other piece of equipment however, the Vortex can be misused in such a way as to cause the user injury, even serious and crippling injury. As the owner of a Vortex it is your responsibility to do the following:

1. Only one person allowed on the slide at any given time.
2. Roughhousing or horseplay on the slide is strictly forbidden.
3. Do not use the slide as a diving platform. The slide is made for sliding only, not diving. **NEVER DIVE FROM ANY PART OF THE VORTEX.**
4. Familiarize yourself with the shape of the pool bottom and the water depth before you slide. Use the correct slide configuration shown on the ladder when sliding.
5. Avoid sliding until all submerged obstacles, surface objects or other swimmers are clear of the slider's pathway.
6. Do not slide into obstructions such as inner tubes, people, water toys, etc., as this increases the potential for a crippling injury to occur.
7. Don't drink alcoholic beverages and slide.
8. Don't slide alone; use the buddy system.
9. The slide is a water slide and should be installed only according to the instructions on pages 3 and 4 of this manual. Don't allow children to use the slide without adult supervision. Users must be swimmers.
10. Take your time in preparing to slide. Move forward slowly and get yourself positioned properly before starting the slide.
11. Handicapped persons should use caution and may require assistance.
12. Do not use the slide if any part of it becomes damaged, weakened, or broken. Don't take chances. Have the slide inspected and, if necessary, repaired by a competent professional, who is familiar with water slides before using the Vortex water slide again. See INSTALLED SLIDES' STRUCTURAL & INSTALLATION CHECKLIST on page 5.
13. Individuals who exhibit frailty due to age should not use the slide.
14. People with history of back problems, heart conditions or fear of heights should not use the slide.
15. People who weigh over 275 pounds should not use the slide.
16. Women who are pregnant should not use the slide.
17. Don't use any other sliding technique, other than the following: see FIG. 5.
18. Hold onto handrails at all times.
19. User must be 48" or taller to use this slide.

SITTING SLIDE POSITION

In the sitting slide position, face forward on the slide holding the legs and arms straight out with the palms of your hands tilted upward as shown in **FIG. 5**.

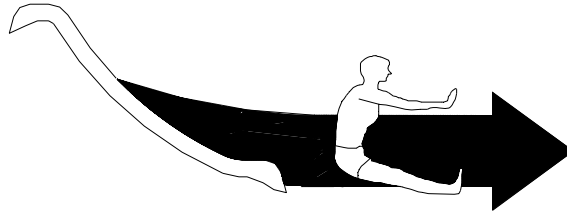

FIG. 5

**** IMPORTANT ****

In order for a person to minimize the possibility of injury, **HEAD FIRST SLIDES ARE STRICTLY PROHIBITED.** (see FIG. 6) It is necessary that the user know that the chief danger of this type of slide is serious spinal injury. Injuries to the spine may result in temporary or permanent paralysis or even death. Research studies have shown that you cannot rely on the water to slow you down sufficiently to avoid injury.

As a Vortex owner, it is your responsibility to explain the nature of this danger to all persons who may use your Vortex, since they may not otherwise appreciate the dangers of performing head first slides.

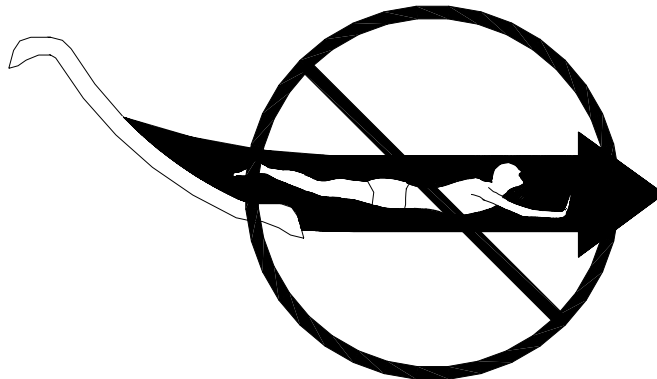

FIG. 6

DO NOT SLIDE HEAD FIRST

DAILY/WEEKLY MAINTENANCE OF THE VORTEX

1. Periodically inspect the Vortex to assure there are no worn parts and that all hardware is properly tightened. Replace any hardware which exhibits rust or corrosion.
2. All slide components require periodic maintenance. Clean components with a cotton cloth and a non-abrasive soap and water. Avoid harsh chemicals and disinfectants.
3. Always read the label instructions on any cleaner carefully before applying it to a surface.
4. Inspect the plumbing system for leaks. Freeze/Thaw cycles may cause leaks at plumbing joints which should be repaired prior to use.
5. Check all safety labels to insure they have not peeled or been removed. Contact S.R. Smith Customer Service (800-824-4397) for replacement labels.
6. The support structure is made from steel, is primed and powder coated with a high quality acrylic urethane finish. However, corrosion may occur depending on water chemistry and environmental conditions. Inspect the slide on a semi-annual basis, sand and repair any surface rust. For touch-up paint (PN # 09-819-1), contact S.R. Smith Customer Service (800-824-4397).

CAUTION: Because this product is manufactured from Steel, placement on a pool with a Salt Chlorine Generator will require frequent inspection and maintenance due to the corrosive nature of these systems with all steel alloys.

CLEANING INSTRUCTIONS

Use nonabrasive soap and water when possible. In addition, you may safely use the below listed products. Always try a test spot before applying to a large area.

Windex® With Ammonia
Soft Scrub®
Glass Plus®

Formula 409®
Scrubfree
Topjob®

Fantastik®
Tackle®
Tilex®

Always read the label instructions on any cleaner carefully before applying it to a *polyethylene* surface.

AVOID HARSH CHEMICALS AND DISINFECTANTS. DO NOT USE:

Dow with Scrubbing Bubbles®
Windex® With Vinegar

Lysol® Disinfectant
White Cap®

Ajax® Cleanser
Ajax® Liquid