

# UV Sterilizer Instruction Manual

---

## Installation and Maintenance For Above Ground and In Ground Pool Models

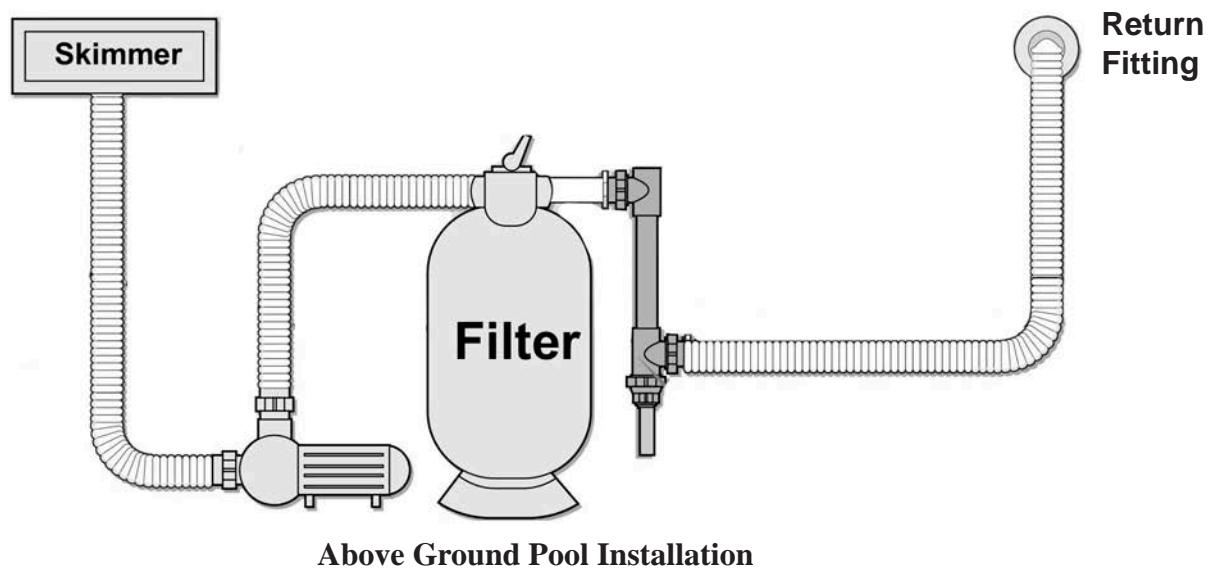
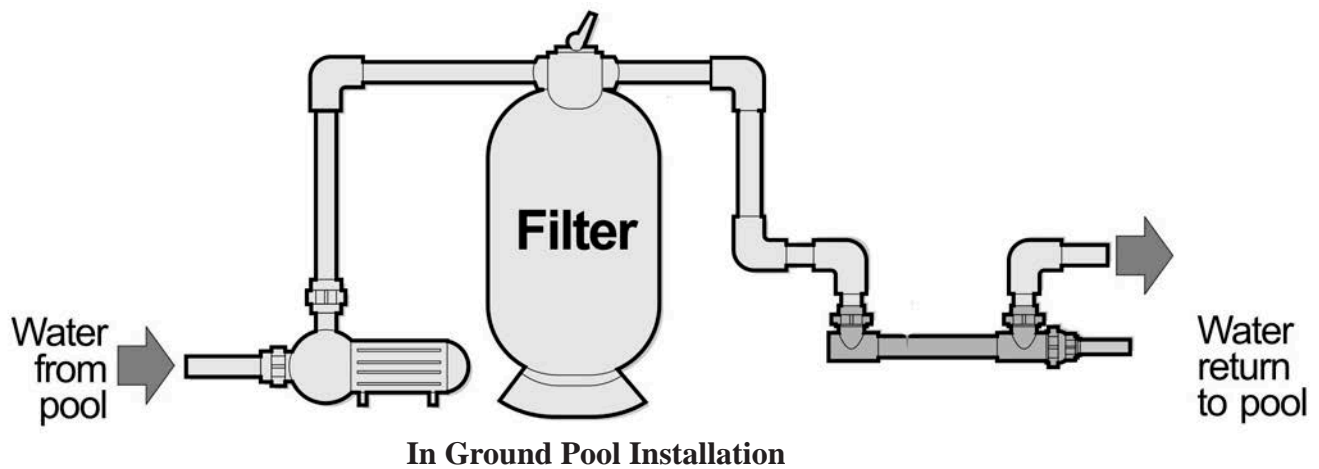

THANK YOU FOR PURCHASING THE BEST ULTRAVIOLET SYSTEM

## IMPORTANT INFORMATION



### WE CAN HELP YOU

Returning this product is expensive and time consuming for you, your retailer and for us, the manufacturer. Should you encounter any problems with your product, **PLEASE DO NOT** return your product to the store! Your dealer or distributor cannot offer any warranty work without authorization from the manufacturer.



In the US please go to our website

[www.solaxx.com](http://www.solaxx.com)

and click the support tab.

**THANK YOU!**

# WARRANTY INFORMATION

---

UV systems are warranted against failure due to defects in materials and/or workmanship during the warranty period. This warranty covers defects occurring under normal use and applies to the original retail purchaser and may not be transferred. The warranty and remedies set forth herein are conditional upon proper storage, installation, use, maintenance and conformance with the applicable use. It will be based upon the manufacturers discretion as to whether the defects are of manufacturing origin.

This warranty does not apply to appearance or accessory items. This warranty does not include damage due to shipping and handling, transportation, unpacking, set up, installation, improper maintenance, incorrect line voltage, modification, abuse, misuse, neglect, accident, fire, flood, acts of God or repair or replacement of parts supplied by any other than the manufacturers .

Any oral statements about this product made by the seller, the manufacturer, their representatives or any other party does not constitute warranties and shall not be relied upon by the user and are not part of this contract.

Neither the seller nor the manufacturer shall be liable for any injury, loss or damages, direct, incidental or consequential including but not limited to lost profits, lost sales, injury, inability to use the product and the user agrees that no other remedy is available.

Before installing, the user shall determine the suitability of the product for their intended use and the user shall assume all risk liability whatsoever in connection therewith.

## **Warranty Period:**

Housing: Three Year warranty on housing against Ultraviolet degradation.

Complete Unit: One year from the date of purchase.

## **Limitations:**

Warranty does not cover any malfunction from improper installation (we recommend that a licensed electrician install your system to the specifications outlined in this owners guide).

Warranty only applies to the original end user and is not transferable.

Warranty does not cover repairs done by anyone other than the manufacturers

Warranty is void if system is not plugged into a G.F.C.I. (Ground Fault Current Interrupter).

Warranty may not be modified by verbal statements by the manufacturer, distributors, retailers, their agents or any other party.

Warranty covers the repair or prorated replacement of the UV products. The manufacturer denies all liability for any other loss including but not limited to loss of equipment, income, livestock or personal injury.

There is no warranty on the Quartz Sleeve.

There are no warranties on broken Lamps. Lamps are prorated by usage.

## **Warranty is voided by the following:**

**Product labels defaced or removed.**

**Housing has been painted.**

**Product is improperly installed or maintained by user or agent.**

**Product abused, misused or damaged by user or their agent.**

**Product damage caused by electrical surges, electrical spikes, electrical brown outs or improper voltage.**

**Electrical cord has been cut.**

**Unit was run without water.**

**Use of anything other than genuine parts.**

Any implied warranty granted under state law including warranties of merchantability or fitness for a particular purpose are limited to one year from the date of purchase. The manufacturer is not responsible for direct, indirect, incidental or consequential damages. Some states do not allow limitations on how long an implied warranty lasts and/or does not allow the exclusions or limitations of incidental damages so the above limitation and exclusion may not apply to you. This warranty gives you special legal rights and you may also have other rights that vary from state to state.

# WARRANTY CONTINUED

---

## **Warranty Returns or Repair Returns:**

Please contact the manufacturer for a "Return Merchandise Authorization" (RMA) number. You must have a valid RMA from the manufacturer's customer service representative before sending any product in for warranty or repair. Please have your serial number, date of purchase and product type available for an RMA number.

All warranty returns or repair returns must come freight prepaid with an RMA number clearly marked on the outside of the box. All other returns will be refused. The manufacturer will not be liable for any shipping cost to return warranty or repair items. Include RMA number, name, address, daytime phone number and brief description of the reason for return or repair inside the box.

Be sure to return product in the same packing or similar packing and insure the package (we recommend sending it UPS).

Solaxx shall not be responsible for damage or loss done by the shipper. Nor shall the manufacturer be responsible for merchandise that arrives damaged due to improper packaging. All claims for loss and damage must be filed by the customer with the shipper.

If the unit is found to be out of warranty we will contact you with the cost of repair. Your authorization is required prior to making any repairs.

# INSTALLATION INSTRUCTIONS

NOTE: All units are quality tested from the factory. All units are rated up to 50 PSI.

Mount your Ultraviolet Sterilizer horizontally or vertically on a wall or above ground, on a level and firm surface. DO NOT LAY THE SYSTEM ON THE GROUND OR WHERE WATER MAY PUDDLE. Your Sterilizer should be easily accessible. Do not submerge.



**WARNING - NEVER LOOK DIRECTLY AT THE LAMP WHEN IT IS LIT. THIS CAN CAUSE SERIOUS EYE DAMAGE! ALWAYS VIEW LAMP THROUGH THE BLUE QUARTZ CAP.**

On all installations, allow space to change the Lamp and Quartz Sleeve.

## Vertical Installation

On a vertical installation, flow must go into the bottom opening and out the top opening. Be careful not to drop the lamp down inside the unit, this can break the Quartz Sleeve. The Quartz Sleeve is not warranted against breakage nor is any damage caused as a result of a broken Quartz Sleeve. Flow can go either way through the UV Sterilizer.

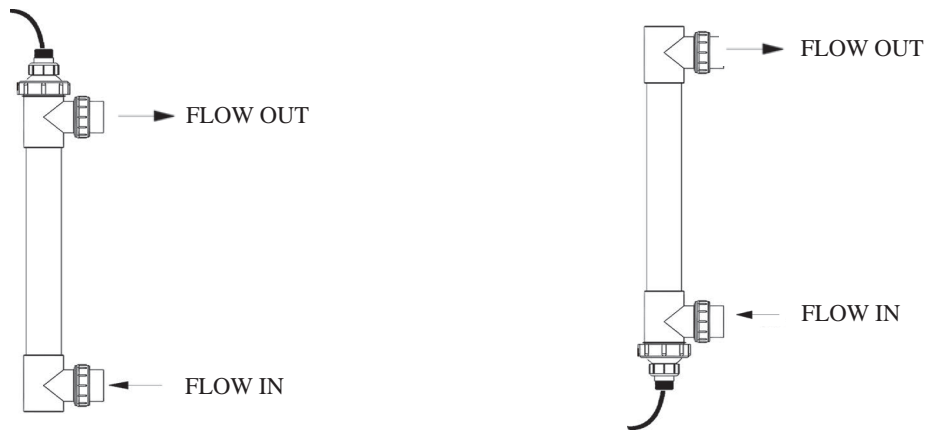

## Horizontal Installation

On horizontal installation, flow can go either direction between the openings. Be careful not to drop the lamp down inside the unit, this can break the Quartz Sleeve. The Quartz Sleeve is not warranted against breakage nor is any damage caused as a result of a broken Quartz Sleeve. Flow can go either way through the UV Sterilizer.

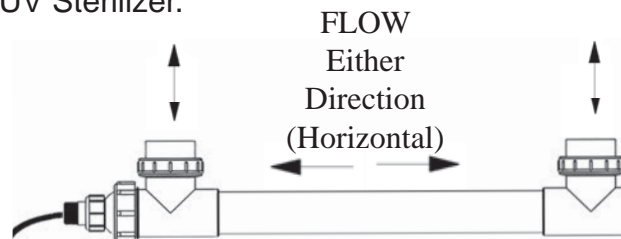

## Transformer Installation

NEVER PUNCTURE TRANSFORMER HOUSING! Use twist ties to secure transformer to pipe or any convenient surface. KEEP TRANSFORMER FROM SITTING IN WATER. USE ONLY GFCI OUTLET.

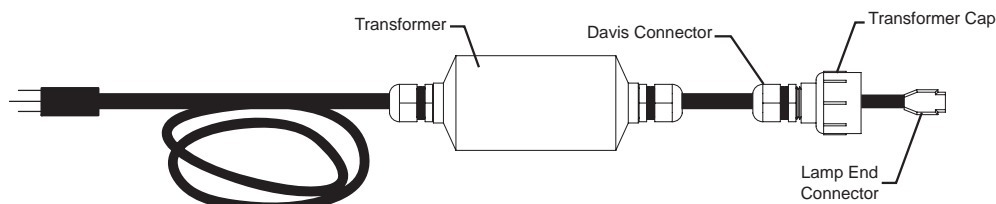

# INSTALLATION INSTRUCTIONS

**CAUTION:** Your unit is not submersible. If this unit falls into the water, turn main power off and then retrieve it. Do not attempt to use this sterilizer if it has been submerged. Do not operate this unit if it has a damaged cord or plug, if it is malfunctioning or if it has been dropped or been damaged in any manner. ALWAYS USE A GFCI PROTECTED POWER SOURCE.

The UV should be installed after the filter on the return line. This helps ensure that the water is clear of debris and impurities that could inhibit the disinfection process. The UV can be installed before the filter, however, it will take longer to work. Note: You increase the risk of breaking the Quartz Sleeve and Lamp if debris enters the UV unit when installed before your filter.

**For Aboveground Pools:** DO NOT INSTALL THE LAMP OR ELECTRICAL COMPONENTS YET. YOU WILL NEED TEFLON TAPE, PVC PRIMER AND GLUE FOR A LEAK FREE INSTALLATION.

**Rigid PVC Pipe:** The unions on the chamber body accept 2 inch rigid pipe. Most aboveground pools use flexible hose but if your aboveground pool has rigid PVC pipe, please stop now and turn to the page that shows installation onto rigid pipe.

**Flexible Hose:** Most aboveground pools use flexible hose for plumbing.

If there is water in the pool, plug the pool return fitting and the skimmer to block water from flowing back from the pool to the pump and filter. Then unclamp the hose going from the filter to the pool return.

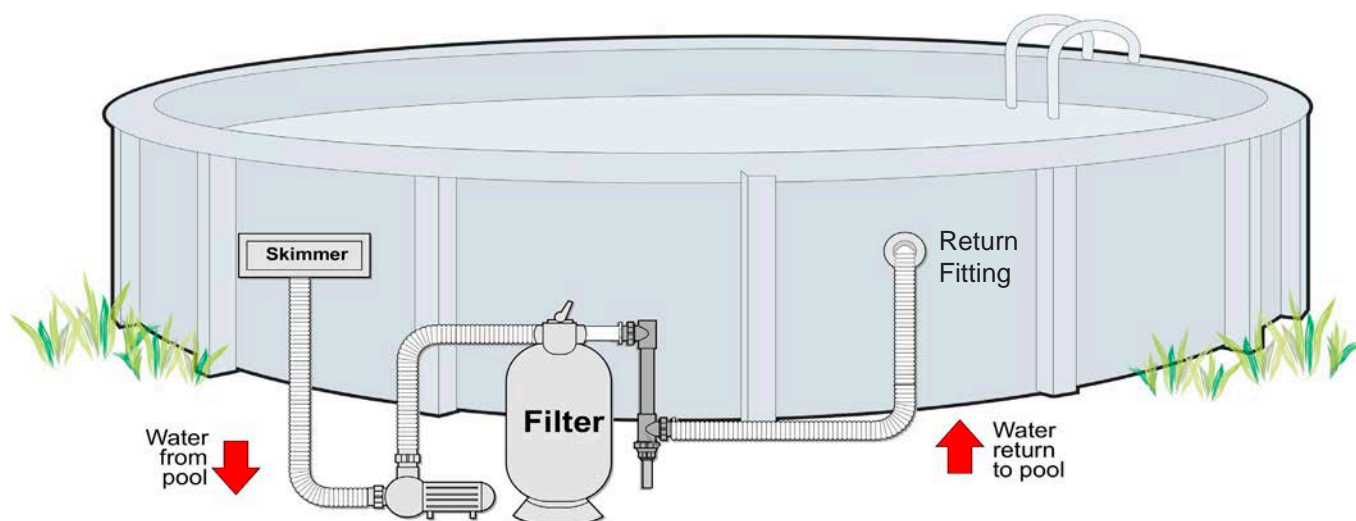

# INSTALLATION INSTRUCTIONS Cont.

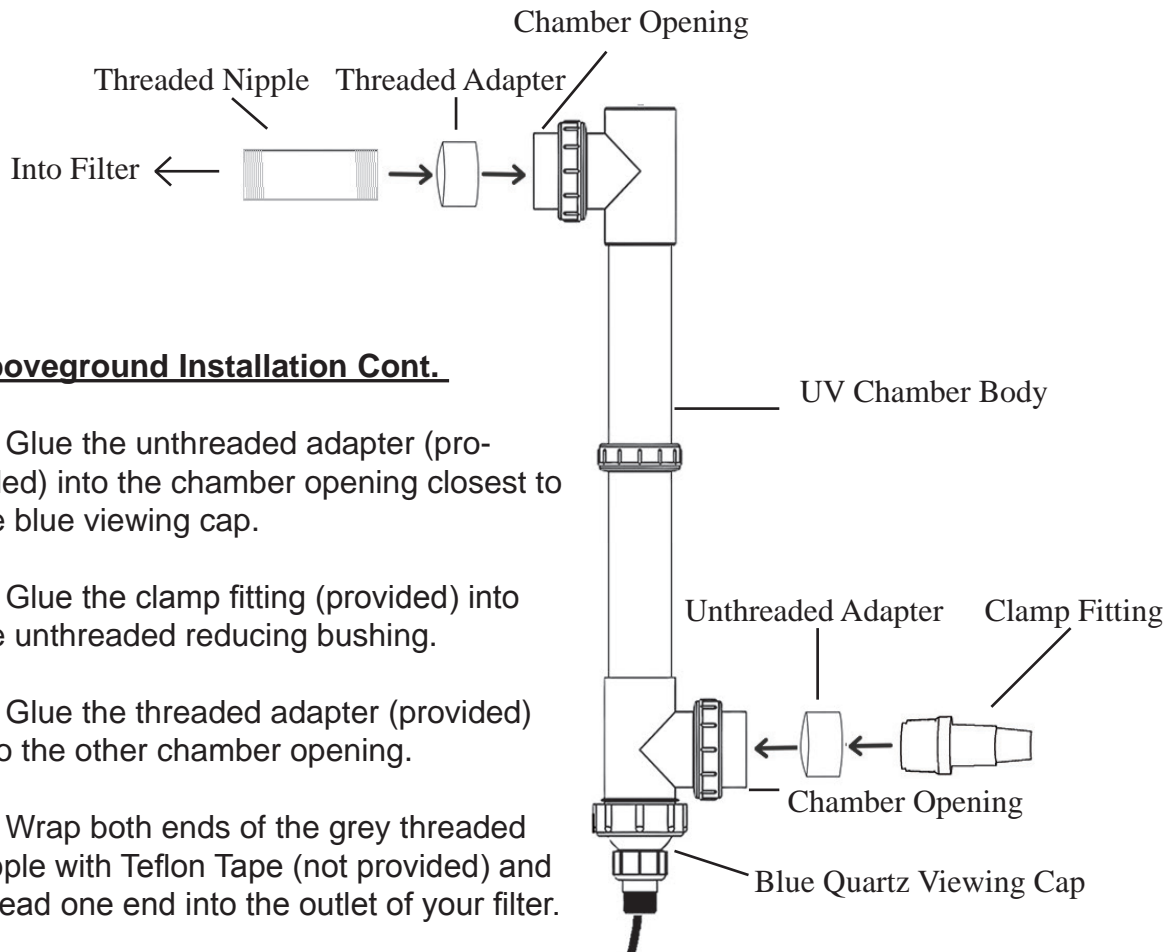

## Aboveground Installation Cont.

1. Glue the unthreaded adapter (provided) into the chamber opening closest to the blue viewing cap.
2. Glue the clamp fitting (provided) into the unthreaded reducing bushing.
3. Glue the threaded adapter (provided) into the other chamber opening.
4. Wrap both ends of the grey threaded nipple with Teflon Tape (not provided) and thread one end into the outlet of your filter.
5. Rotating the UV body, thread the entire UV chamber onto the threaded nipple extending out of the filter. Make sure the connection is tight and leave the chamber in a vertical position with the blue viewing cap at the bottom.
6. Clamp the flexible hose coming from the pool wall onto the clamp fitting on the chamber opening.
7. Turn on pump and run for five minutes to check for leaks. If the unit leaks, turn off pump and continue troubleshooting for leaks.
8. Using the zip ties provided, mount the transformer to any convenient hose, pipe or post to keep it off the ground. Use only GFCI outlet.

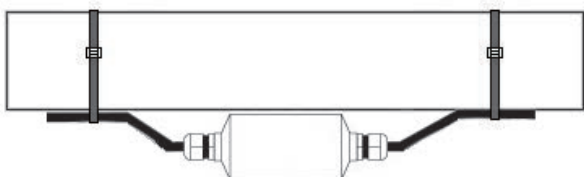

## Above Ground Installation

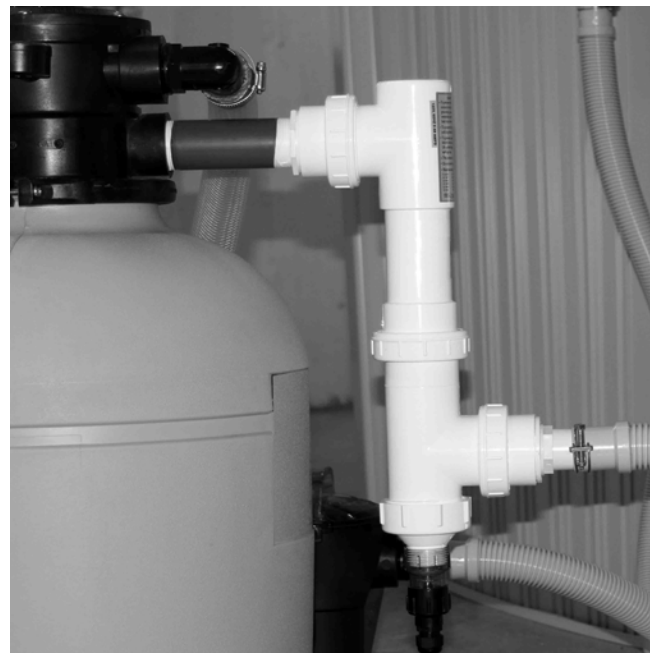

The UV Sterilizer is mounted directly to the filter using the threaded nipple provided

# INSTALLATION INSTRUCTIONS Rigid PVC Pipe

**For Inground Pools: DO NOT INSTALL THE LAMP OR ELECTRICAL COMPONENTS YET. YOU WILL NEED PVC PRIMER AND GLUE FOR INSTALLATION.**

1.) The UV system comes equipped with 2" unions. If your plumbing is 1.5", use the reducer elbows provided. Locate a section of plumbing after your filter where you can remove a 15" segment. Cut out the segment of PVC using a proper saw and make sure cuts are straight. Next, glue the 90° street elbow (provided) to each side where you cut and make sure both sides are positioned identically. Align the UV chamber unions to the 90° elbows and glue them together. **MAKE SURE NOT TO DRIP GLUE INTO THE UV CHAMBER.**

Inground Installation

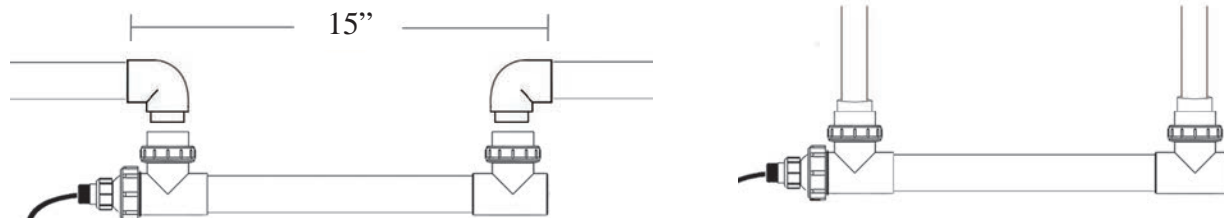

2. Based on your personal plumbing configuration, additional plumbing supplies may be needed.
3. Make sure the unit is mounted securely before operating.

**4. MOUNT THE TRANSFORMER SO IT DOES NOT SIT IN WATER. USE ONLY GFCI PROTECTED POWER SOURCE. USING THE ZIPTIES PROVIDED, MOUNT THE TRANSFORMER TO ANY CONVENIENT PIPE OR POST TO KEEP IT OFF THE GROUND.**

5. LEAK TEST: Do not install the Lamp or electrical components yet. After all connections have been made, turn on the pump and run for five minutes to check for leaks.

- a. If there are no leaks, turn pump off and continue installing the lamp.
- b. If unit leaks, turn pump off and continue to troubleshooting for leaks.

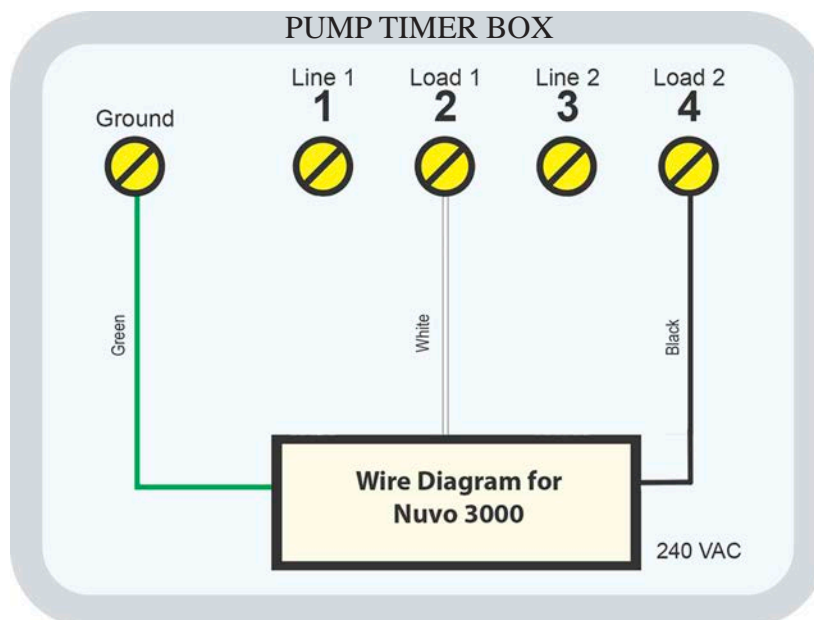



# TROUBLE SHOOTING LEAKS



**WARNING - NEVER LOOK DIRECTLY AT THE LAMP WHEN IT IS LIT. THIS CAN CAUSE SERIOUS EYE DAMAGE! ALWAYS VIEW LAMP THROUGH THE BLUE QUARTZ CAP.**

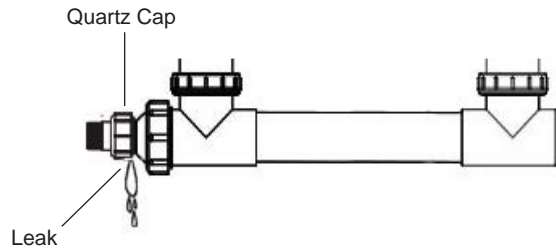

## Leaks from Quartz Cap / Rubber Seal

Undo Quartz Cap and push Rubber Seal into the Sterilizer body evenly. Half of the Rubber Seal will still be in view. Screw on the Quartz Cap and finger tighten. Do not use a pipe wrench, pliers or any other tool. Hand-tighten only. Do not use any lubricant.

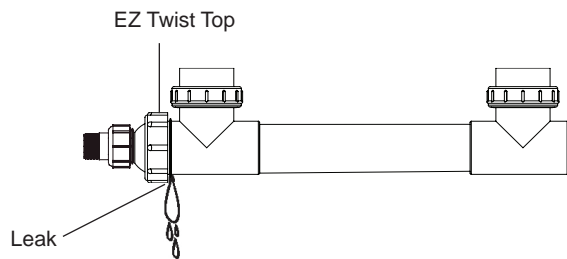

## Leaks from the EZ – Twist Top

Check that the O-ring is in the EZ-Twist Top. Hand tighten EZ-Twist Top until leak stops. Do not use any lubricant.

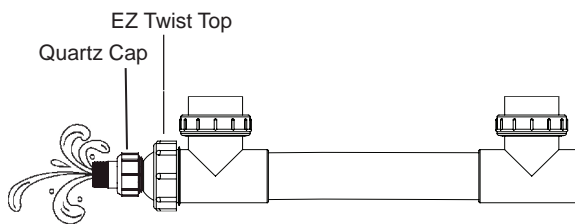

## Leaks from Center of Quartz Sleeve

The Quartz Sleeve is broken and needs to be replaced. Neither the broken Quartz Sleeve nor any damage caused as a result of a broken Quartz Sleeve is covered under warranty. Contact your dealer for a replacement. (See Replacing the Quartz Sleeve on page 13).

# INSTALLING THE LAMP



**NOTE:** If you touch the Lamp use denatured alcohol and a soft cloth to clean the Lamp. If you do not clean the Lamp the fingerprints will become etched into the glass which will diminish UV output and may cause premature lamp failure.



**NOTE:** Lamps and Quartz Sleeves should be handled with care. Lamps and Quartz Sleeves are not warranted against breakage or damage.



**WARNING:** Do not install the Lamp at an angle (even a slight angle); this may cause a U shaped crack at the end of the Quartz Sleeve, or possible breakage of the Lamp. If this should happen, do not proceed with the installation. Purchase a new Quartz Sleeve or Lamp from your dealer and refer to the proper installation instructions.



**NOTE:** Do not force the Lamp into the Quartz Sleeve.

1. Unscrew the Davis Connector located behind the Transformer Cap, this allows your Transformer Cap to spin freely.

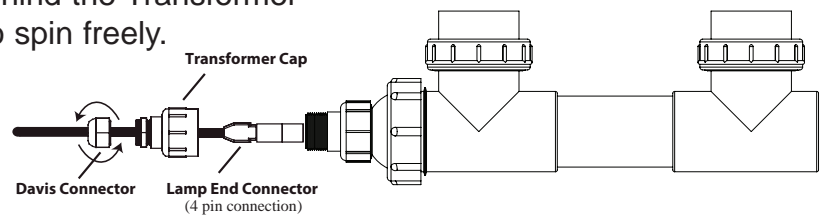

2. Plug the Lamp flush into the Lamp End Connector before inserting the Lamp into the unit. If the Lamp is not plugged in all the way it may cause damage to the unit which is not covered under warranty.

3. Insert the Lamp straight into the Quartz Sleeve. Be careful, inserting the Lamp at an angle, even a slight angle, can cause a "U" shaped crack in the Quartz Sleeve.

4. Twist the Transformer Cap onto the Quartz Cap. Do not over tighten. This is a connection only and is not in contact with water.

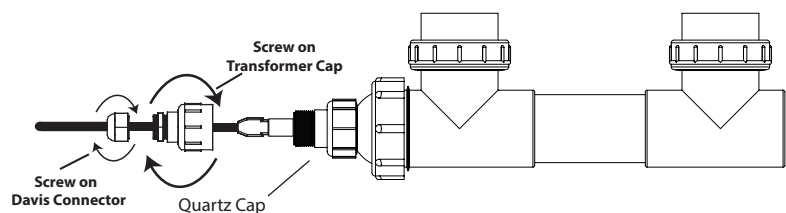

5. Tighten the Davis Connector back on to the Transformer Cap.

6. **FINAL LEAK CHECK:** Do not plug the Sterilizer into power yet. Turn on the pump, let water run for 5 minutes and check for leaks. (See page 14 for trouble shooting leaks).

7. Once a leak test is completed, and there are no leaks, plug the Transformer into a GFCI outlet. **KEEP THE TRANSFORMER OFF THE GROUND - DO NOT ALLOW TRANSFORMER TO LAY IN STANDING WATER**

# WINTERIZING



**CAUTION: Always turn off the pump and disconnect electricity from the unit prior to any maintenance.**

Option 1: If you are going to continually run water through your unit and it will be exposed to freezing temperatures be sure to install winterizing caps (sold separately) on the unit and take all the internal parts inside (Quartz Sleeve, EZ-Twist Top, Quartz Cap, Lamps, Rubber Seals, and Transformers.)

## Take these parts inside

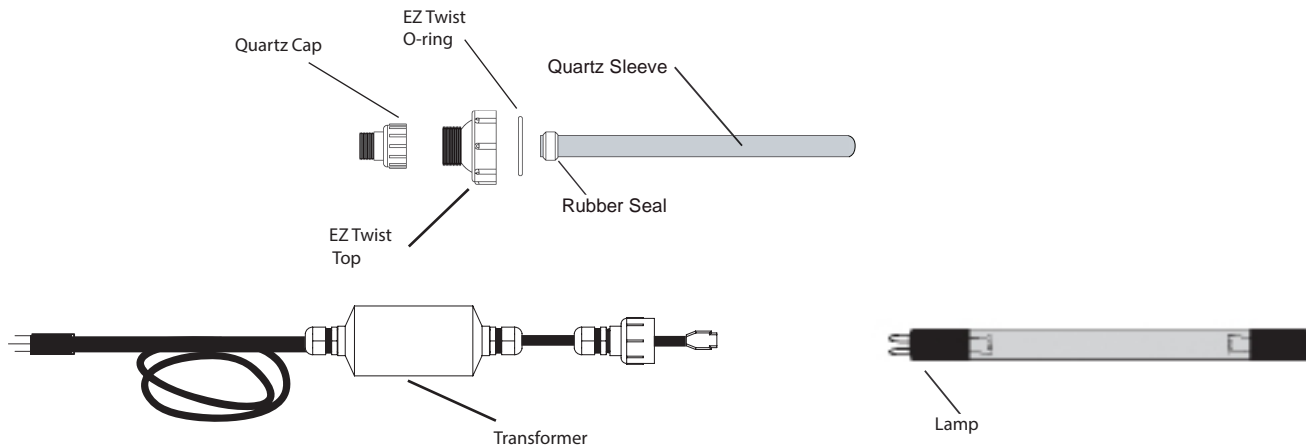

Option 2: If you are not flowing water through your system, use a winterizing cap, drain the unit completely and take the internal parts inside. If the unit is not completely drained, the water will freeze and crack the housing. This is not covered under warranty.

Option 3: If you don't have a winterizing cap and are not going to run water through the system, remove the Lamp, disconnect unions and take the Sterilizer inside. Store the Lamp separately to avoid breakage.

# MAINTENANCE



**CAUTION:** Always turn off the pump and disconnect electricity from the unit prior to any maintenance.

## Changing the Lamp.

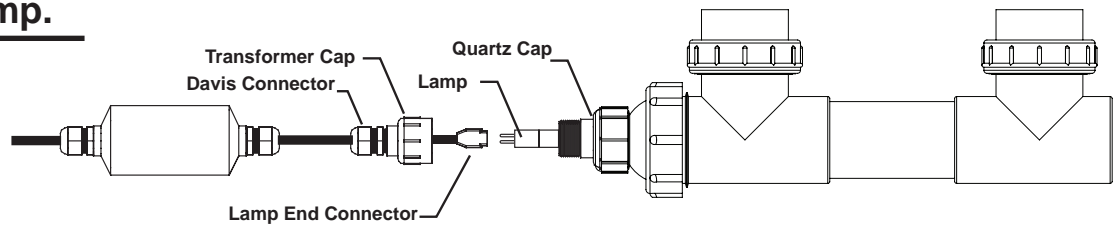

1. Unplug the UV from the power source and turn off the pump.

2. Unscrew the Davis Connector located behind the Transformer Cap, this allows your Transformer Cap to spin freely.

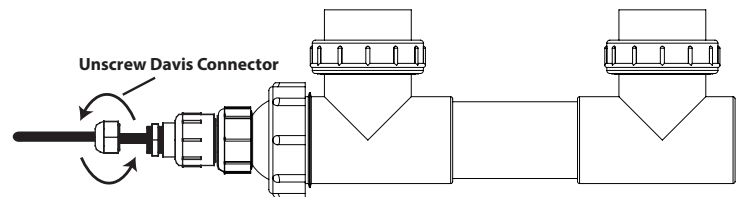

3. Twist off the Transformer Cap.

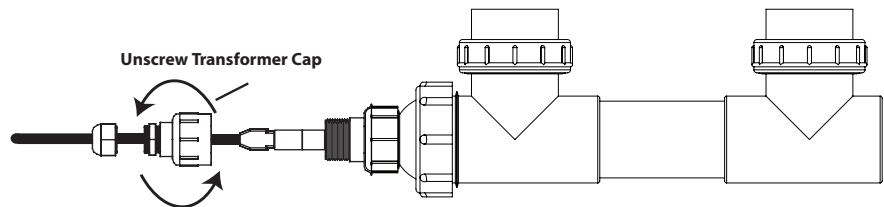

4. Slide Lamp out, be careful not to slide the Lamp out at an angle, even a slight angle, this may cause a "U" shaped crack at the end of the Quartz Sleeve, or possible breakage of the Lamp. A Broken Lamp or Quartz Sleeve is not covered under warranty.

5. Disconnect the Lamp End Connector from the old Lamp.

6. Plug the new Lamp flush into the Lamp End Connector. If the Lamp is not plugged in all the way it may cause damage to the unit and is not covered under warranty.

7. Insert the Lamp straight into the Quartz Sleeve. Be careful, inserting the Lamp at an angle, even a slight angle, can cause a "U" shaped crack in the Quartz Sleeve.

8. Twist on the Transformer Cap. Do not over tighten. This is a connection only and is not in contact with water.

9. Tighten the Davis Connector located behind the Transformer Cap.

10. FINAL LEAK CHECK: Do not plug the Sterilizer into power yet. Turn on the pump, let water run for 5 minutes and check for leaks.

11. Once a leak test is completed and there are no leaks, plug the Transformer into a GFCI outlet. Warranty is void if not plugged into a GFCI.

# CLEANING THE QUARTZ SLEEVE

## Clean The Quartz Sleeve After 3-6 Months Of Use.

1. Unplug the UV from the power source and turn off the pump.

2. Unscrew the Davis Connector located behind the Transformer Cap, this allows your Transformer Cap to spin freely.

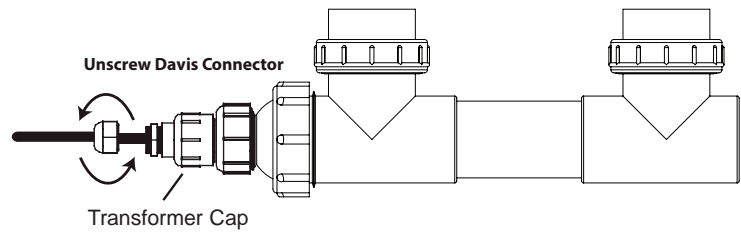

3. Twist off the Transformer Cap.

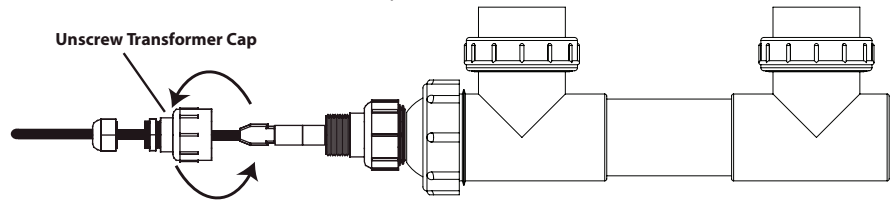

4. Slide Lamp out, be careful not to slide the Lamp out at an angle, even a slight angle, this may cause a "U" shaped crack at the end of the Quartz Sleeve, or possible breakage of the Lamp. Set the lamp on a secure level surface to avoid breakage.

5. Remove the E-Z Twist Top. The Quartz Sleeve Assembly will come out with it. Be careful to pull it out straight.



**NOTE:** The Lamps and Quartz Sleeves should be handled with care. Lamps and Quartz Sleeves are not warranted against breakage and damage.

6. The Quartz Sleeve can be cleaned with Lime Away, CLR or similar products.

Do not use any type of abrasive substance on the Quartz Sleeve as it may scratch the Quartz.

7. To reinstall the Quartz Sleeve, carefully insert the Quartz Sleeve into the end of the UV body. Be sure the Quartz Sleeve is seated in the bottom of the UV Unit.

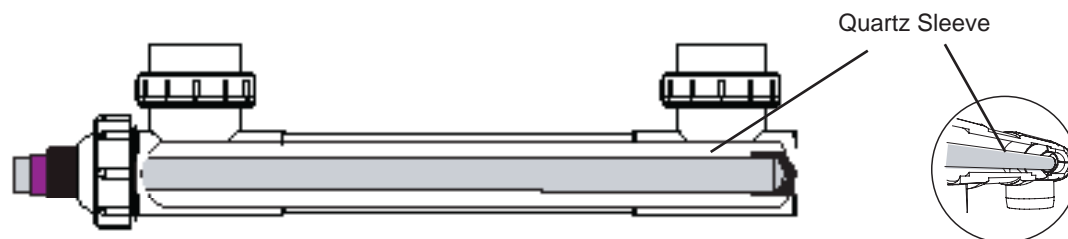

8. Screw on the E-Z Twist Top. Do not use a pipe wrench, pliers or any other tool on this unit. Tighten by hand only. Re-install the Lamp as Shown on page 19, starting at #6.

# REPLACEMENT OF THE QUARTZ SLEEVE

1. Unplug system, turn pump off and drain housing. Remove Lamp and Transformer.

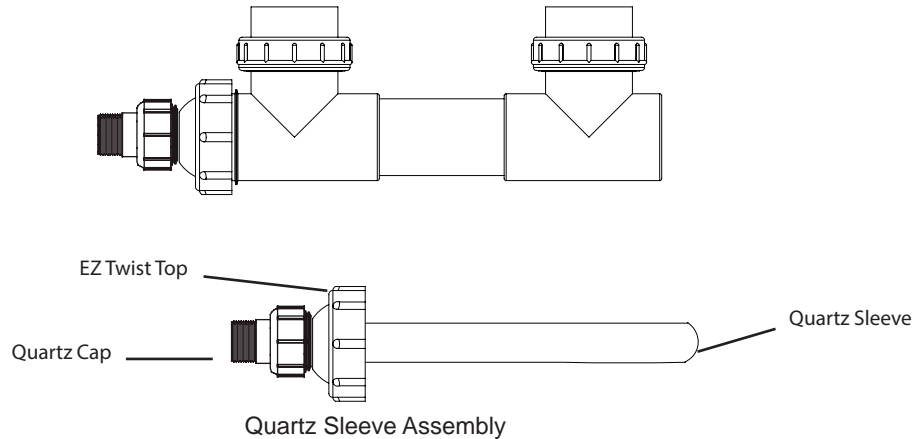

2. Untwist E-Z Twist Top. This will release the Quartz Sleeve Assembly. Pull The Quartz Sleeve Assembly straight out of the housing.
3. Untwist Quartz Cap. Push Quartz Sleeve up through E-Z Twist Top. Be careful not to break the Quartz Sleeve. Handling broken glass can cause injury. If your Quartz Sleeve is broken protect your hands before servicing.

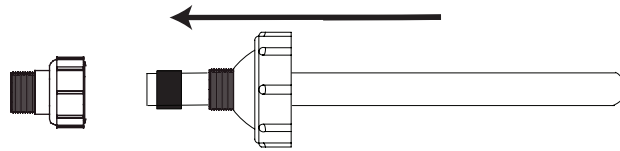

4. Discard old Quartz Sleeve and Rubber Seal, be sure to use only genuine manufacturer Quartz Sleeves.
5. Re-install E-Z Twist Top without Quartz Sleeve. Slide Quartz Sleeve into the housing. Be sure to center the quartz sleeve into the seat at the bottom of the unit.

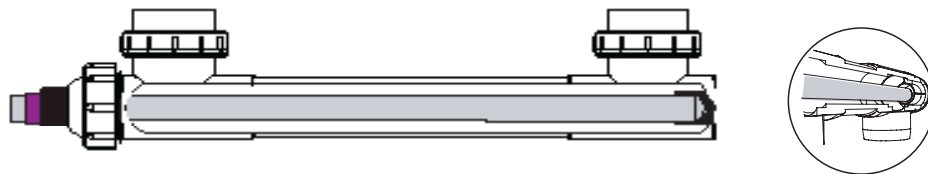

6. Gently push the Quartz Sleeve and Rubber Seal in to the E-Z Twist Top until only  $\frac{1}{2}$  of the rubber seal is visible.

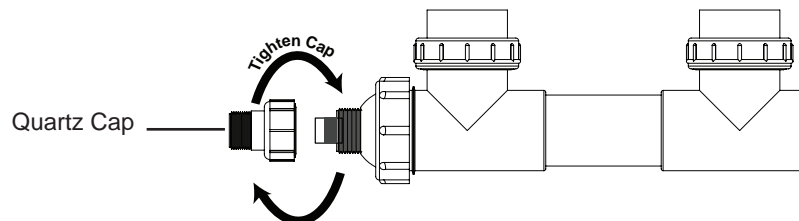

7. Twist on the Quartz Cap. DO NOT use a pipe wrench, pliers or any other tool on this unit. Tighten by hand only.

To Reinstall the Lamp

Go to step #6 under changing the Lamp.

# INCORRECT INSTALLATIONS

The Following will Damage the Unit's Electrical Components

Incorrect: EZ Twist Top Over Rubber Seal  
See Page 13 for Proper Quartz Sleeve installation

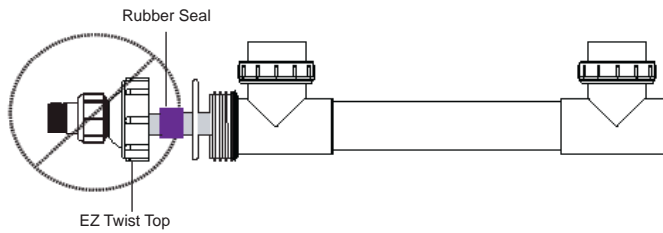

Incorrect: Rubber Seal is Outside of Quartz Cap  
See Page 13 for Proper Quartz Sleeve installation

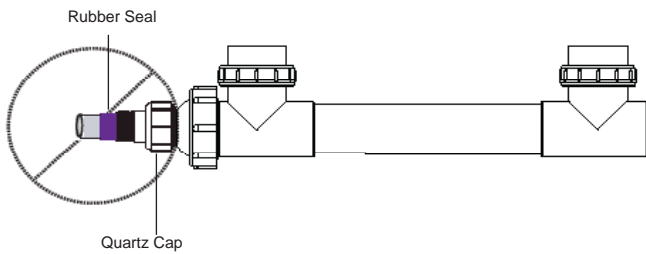

Incorrect: Quartz Sleeve Not Seated  
See Page 13 for Proper Quartz Sleeve installation

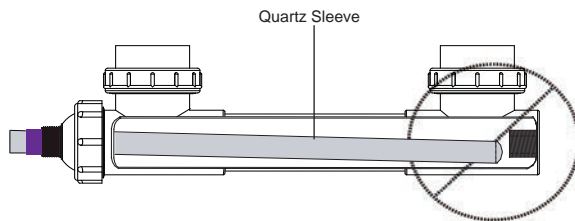

Incorrect: Lamp at an Angle will create a U Shaped Crack  
See Page 12 for Proper Lamp installation

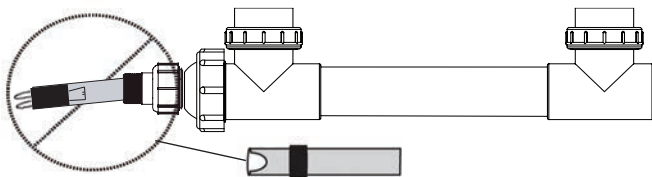

Incorrect: Lamp Not Plugged Flush with Lamp End Connector  
See Page 12 for Proper Lamp installation

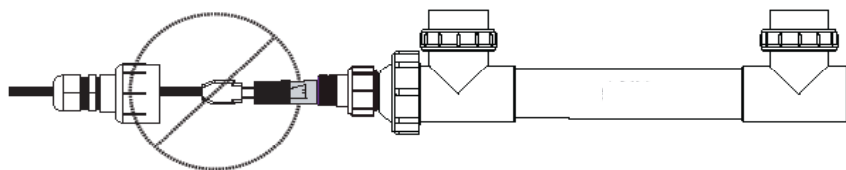

# PARTS LIST

Use genuine Solaxx Parts or the warranty is voided.

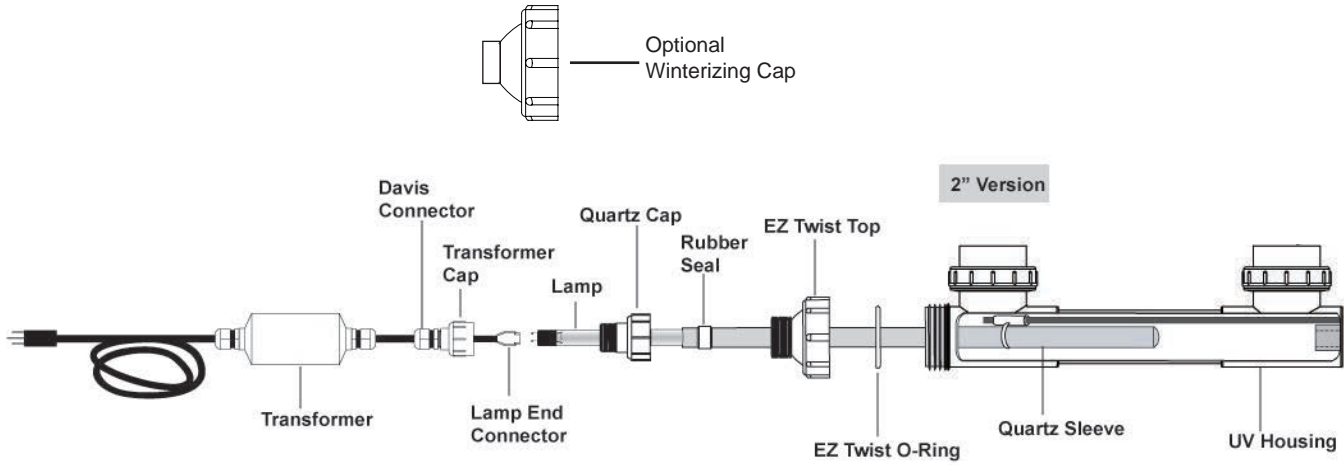

## PARTS LIST TRANSFORMERS

### INLINE TRANSFORMERS

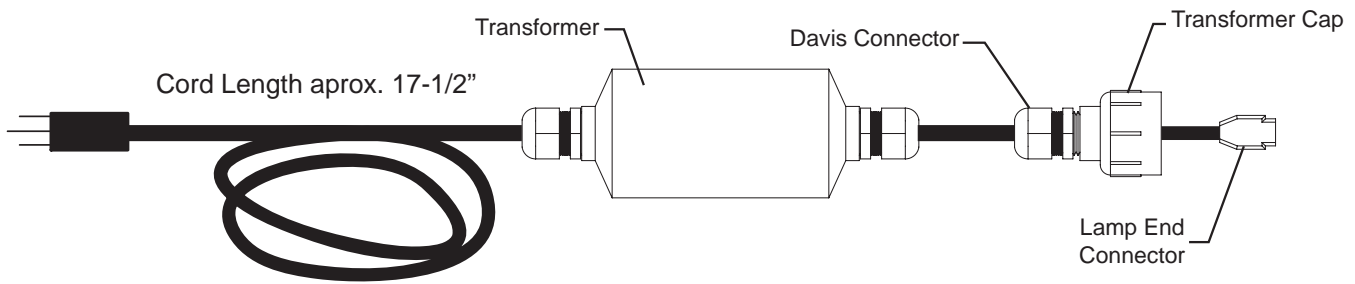

Cords not sold separately