

LESLIE'S LINER MEASURING MADE EASY

PHONE: 800-537-5437 • FAX: 866-298-0173

www.lesliespool.com • Email: customforms@lesl.com

IMPORTANT!

All liner prices are quoted based on the accurate measurements you provide and the pattern you select. Please read all instructions before you attempt to begin measuring.

GENERAL INSTRUCTIONS TO AVOID COMMON MEASURING ERRORS

- Draining your pool will make the measuring process easier, however, it is not required.
- Measuring your pool will be easier if you have another person helping you.
- Write your measurements legibly, using **Black Ink**.
- **Make Copies of all Pages for your Records Before Mailing them to Us.** You will need to refer to your copies if we have questions regarding your measurements.
- Actual pool measurements should be made even if original pool plans are available due to the fact that slight variances may have occurred during construction. The builder may not have followed the pool plan precisely.
- When measuring the pool, do not make allowances for weather conditions, temperature, or the fact that vinyl shrinks and expands.
- Please supply all measurements in feet and inches.
- All pools are different. Please measure your pool for an exact fit.
- Follow these “step by step” instructions carefully, referring to all diagrams to ensure accurate measurements. Remember to include your **Name, Address, Phone Number** and **Email** on each page that you send to us.
- Remember to record ALL of your measurements on **Page 1** of the **Measuring Form**.

WRITE
LEGIBLY
WITH BLACK
INK

MAKE
COPIES FOR
YOUR
RECORDS

MEASURE
IN FEET.
& INCHES

INCOMPLETE INFORMATION CAN DELAY THE SPEED & ACCURACY OF YOUR QUOTE & ORDER.

MEASURING INSTRUCTIONS

STEP 1: INDICATE YOUR LINER TYPE

Refer to **Page 1** of the **Measuring Form** to select the correct liner type. If you have a Beaded liner, select “beaded” or “Low Hung beaded.” For beaded liners refer to **Diagram 1** to view standard and reverse bead. If you have an overlap liner please indicate the amount of overlap you need in inches.

STEP 2: CHOOSE YOUR POOL SHAPE

Select your **Exact** pool shape from those provided in **Diagram 2**. Record your pool shape on **Page 1** of the **Measuring Form**, then proceed to **Step 3**. If your pool shape is not shown on **Diagram 2**, please refer to **Diagram 3**.

STEP 3: CORNER TYPE

Refer to **Diagram 4** to select the corner type on your pool. Record your corner type and the measurements indicated on **Page 1** of the **Measuring Form**.

Note: If you have more than one type of corner on your pool (such as with a Lazy “L” pool), please include a sketch of your pool indicating each corner type and the appropriate measurement along with the rest of the measuring forms.

STEP 4: MEASURE THE LENGTH (A) & THE WIDTH (B)

Refer to the illustration of your pool that you selected in **Step 2**. Be sure that the **Length (A)** and the **Width (B)** measurements are made at the **Bead Receiver** (where the liner snaps into the track), **Not** at the edge of the coping (the edge of the pool deck). Record your measurements in the “Dimensions” section of **Page 1** of the **Measuring Form**.

Note: If your pool is an “L” or “Lazy L” Shape, take All measurements for “A” and “B”, including A1, A2, A3, A4, B1 and B2.

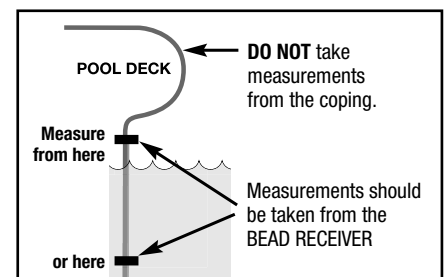

MEASURING INSTRUCTIONS continued

STEP 5: MEASURE DIAGONALS – RECTANGLE & “LAZY L” POOLS ONLY

If your pool is not a rectangle or a “Lazy L,” proceed to **Step 6**. For a Rectangle pool, you will need to measure the pool on the diagonals (R and Q). For a “Lazy L” pool, you will need to make 2 sets of diagonal measurements: (Z1, Z2) and (Z3, Z4). Remember to make all of these measurements from the **Bead Receiver**, not the coping (refer to the illustration in **Step 3**). Refer to the diagram of your pool shape in **Diagram 5**.

Measure Diagonal from Squared Corners: if the corners are rounded (radius) or cut (diagonal), be sure to measure to squared corners. Refer to **Diagram 4** for instructions on measuring to squared corners. Record your measurements in the “Dimensions” section of **Page 1** of the **Measuring Form**.

STEP 6: MEASURING SHALLOW END COVERED BOTTOMS

Refer to **Diagram 2** to determine if you have a Shallow End Covered Bottom. If you have a Shallow End Covered Bottom, follow the four easy steps in **Diagram 5** to take measurements (C), (T), (U) and (V). If you do not have a Shallow End Covered Bottom, proceed to **Step 7**.

STEP 7: HORIZONTAL MEASUREMENTS OF POOL BOTTOM & DEPTH MEASUREMENTS

Refer to **Diagram 6** for instructions on how to take these measurements. Make sure that you are taking measurements of the pool bottom on a horizontal plane. **If you measure the slopes of the pool, you will have an incorrect measurement.** The measurements you take will depend on what style of bottom contour your pool has. Select the bottom contour of your pool from **Diagram 6** and take the measurements accordingly. Record all measurements in the “Dimensions” section of **Page 1** of the **Measuring Form**.

STEP 8: CONTINUE MEASURING ACCORDING TO YOUR POOL SHAPE DIAGRAM

Refer to your pool shape diagram to complete the rest of the measurements asked for. Record your measurements in the “Dimensions” section of **Page 1** of the **Measuring Form**.

STEP 9: VINYL – COVERED STEP SECTIONS

If your pool has a built-in step section that is covered with vinyl, you must complete **Page 2** of the **Measuring Form**. Please check the “Vinyl-Covered Step Sections” box on **Page 1** of the **Measuring Form**.

STEP 10: INDICATE LINER PATTERN & GAUGE

Choose up to 2 liner patterns and corresponding gauges that you would like to receive quotes on.

STEP 11: REVIEW

Review all of your measurements, being sure that all of the “Quick Checks” are correct.

DIAGRAM 1: STANDARD OR REVERSE BEAD

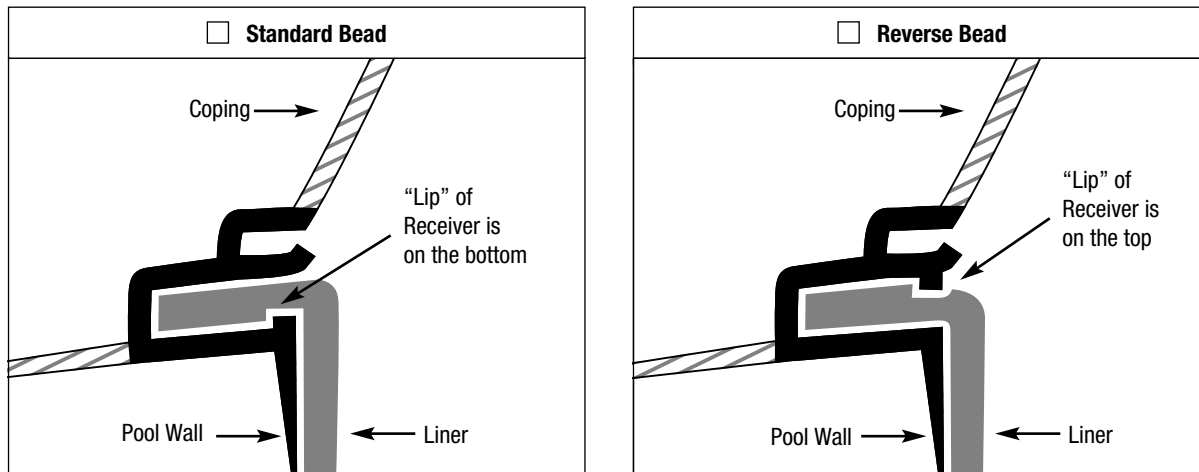

DIAGRAM 2: POOL SHAPES

Identify the shape of your pool from the illustrations below. You will need to make all of the measurements indicated (detailed instructions for measuring are in the **Measuring Instructions**). If you have any unusual features on your pool that extend into the pool (such as a built-in spa, fountain or water feature, etc.) you will need to draw these on the diagram, take measurements and send us the diagram along with the rest of your measuring form. It is also helpful to include photos of these types of unusual features.

What if My Pool Shape Is Not Illustrated Below? If you do not see your pool shape below, look at **Diagram 3** and follow the instructions.

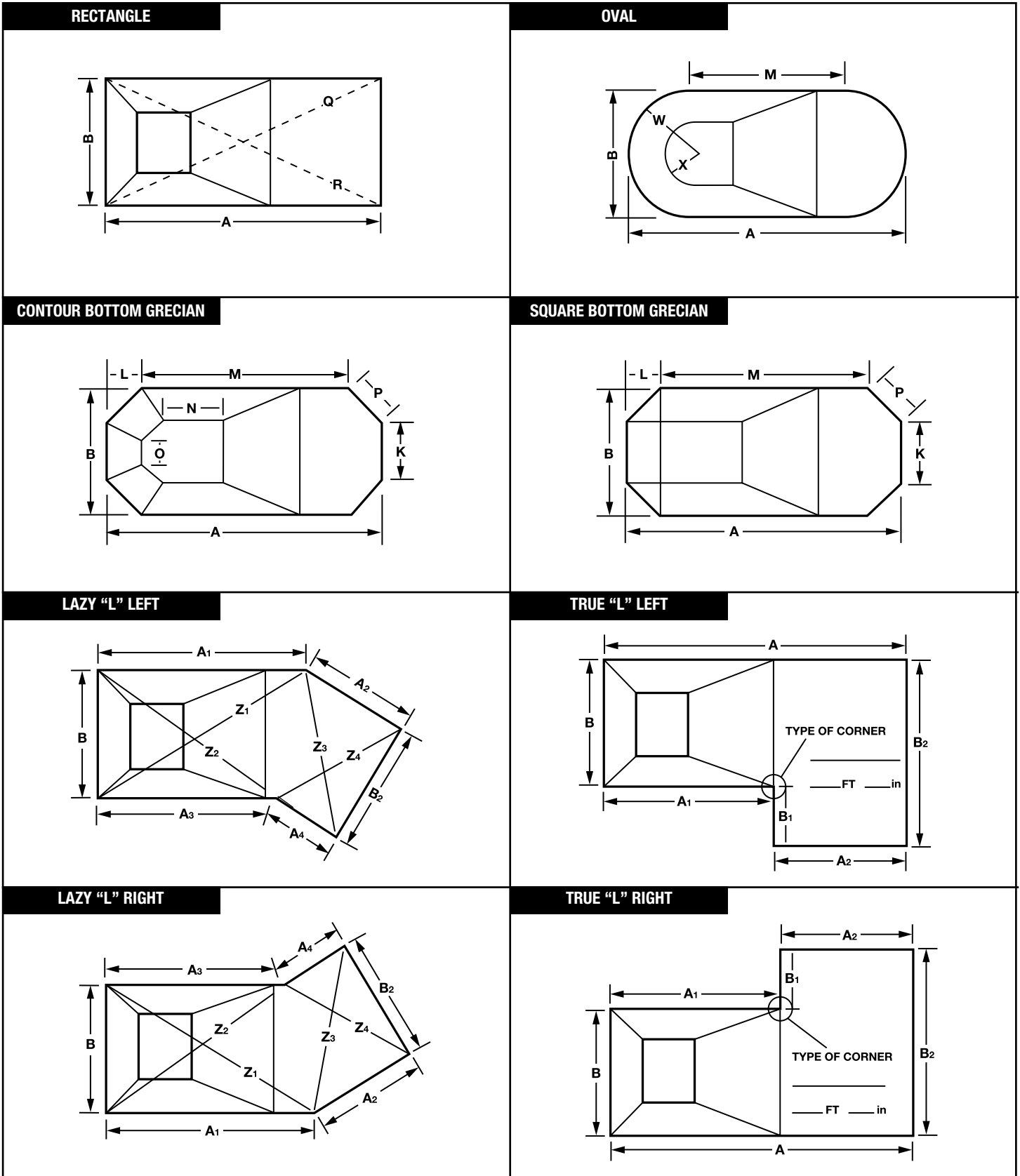

DIAGRAM 3: OTHER POOL SHAPES

If you did not find your pool shape in Diagram 2, find your pool shape on this page. Call us at 800-537-5437 (or fax us at 1-877-292-5773 or email us at customforms@lesl.com) with the drawing reference number of your pool shape (DWG-00-xxx).

Note: You will still need to follow the rest of the steps in the Measuring Instructions and fax in Page 1 of the Measuring Form with the required information for an estimate on your liner.

If your pool shape is not pictured here, please call us at 800-537-8437 for assistance or email us at customforms@lesl.com.



<p>DWG 00-203</p> 	<p>DWG 00-302</p> 	<p>DWG 00-303</p> 
<p>DWG 00-401</p> 	<p>DWG 00-402</p> 	<p>DWG 00-403</p> 
<p>DWG 00-404</p> 	<p>DWG 00-501</p> 	<p>DWG 00-502</p> 
<p>DWG 00-503</p> 	<p>DWG 00-504</p> 	<p>DWG 00-505</p> 
<p>DWG 00-506</p> 	<p>DWG 00-601</p> 	<p>DWG 00-701</p> 
<p>DWG 00-702</p> 	<p>DWG 00-703</p> 	<p>DWG 00-704</p> 

DIAGRAM 4: MEASURING WITH CORNERS

Choose your corner type from the illustrations below. Remember to indicate your corner type on **Page 1** of the **Measuring Form** and to provide the required measurements.

INSTRUCTIONS FOR STEP 5: MEASURING DIAGONALS

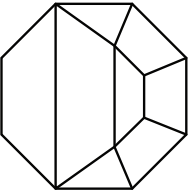
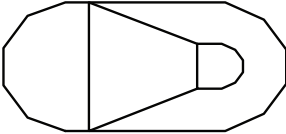
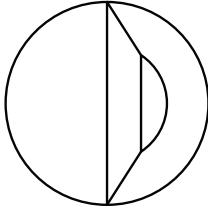
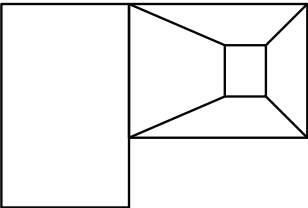
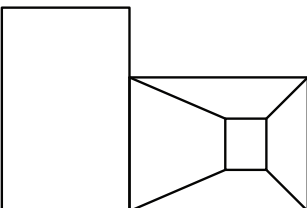
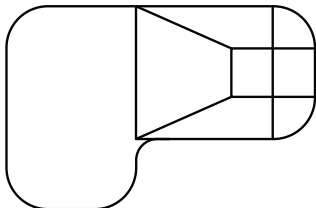
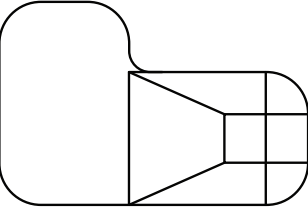
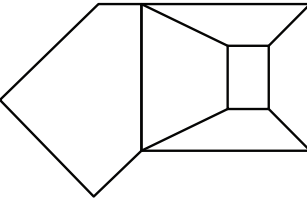
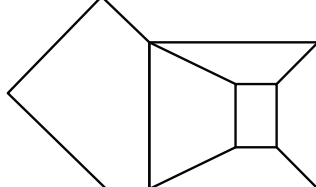
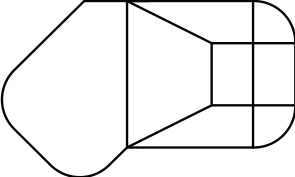
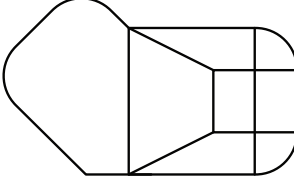
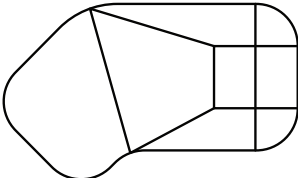
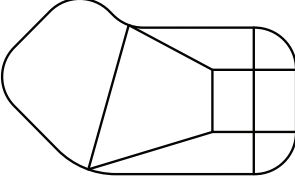
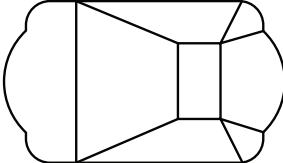
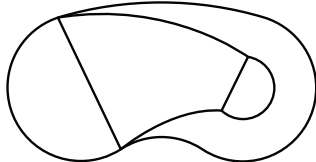
(Q and R) for Rectangle and (Z1, Z2, Z3, Z4) for "Lazy L" Pools: When measuring Diagonals for pools with radius (rounded) or cut (diagonal) corners. **Be sure to measure from Point 1, (on Image B), NOT the Edge of the Pool! Point 1 = Imaginary Corner where Sidewalls would meet if they were extended to make a square corner**

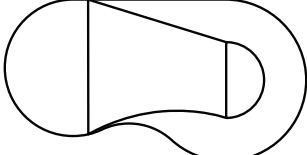
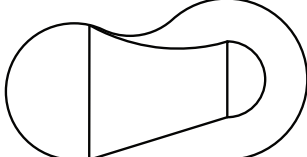
CUT CORNERS (Diagonal)

Cut corners must be measured. Refer to Image A. **Record this measurement for Cut Corners on Page 1 of the Measuring Form:**

Point 1 to Point 2: _____

RADIUS (Rounded) CORNERS

Radius corners must be squared before measuring. Use 2 straight edges to form an imaginary square corner, mark where the edges meet as Point 1. Measure from imaginary corner (Point 1) to Point 2. Refer to Image B. **Record this measurement for Radius Corners on Page 1 of the Measuring Form:**

Point 1 to Point 2: _____

90 DEGREE CORNERS (Square)

No additional measurements are required. Select "90 Degree" corner on **Page 1 of the Measuring Form:**

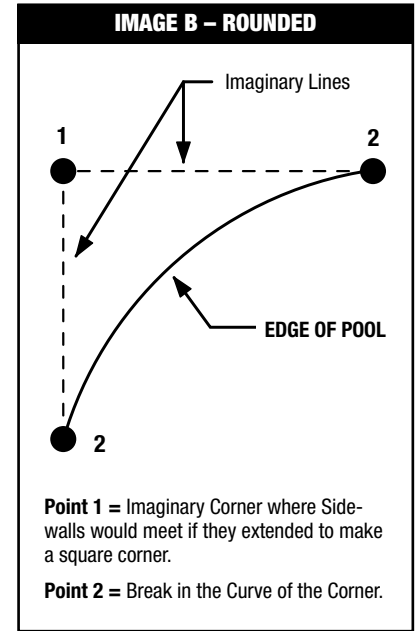
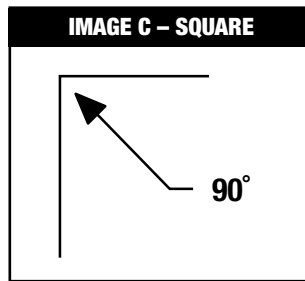
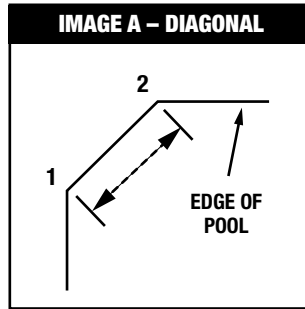

DIAGRAM 5: SHALLOW END COVERED BOTTOM

STEP A: Measure the depth (C) of the shallow end of your pool. Be sure to measure from the bottom of the pool floor to the bead receiver (for beaded liners) OR to the board where the liner is nailed/stapled (for overlap liners). **Do Not** measure to the top of the pool if you have a beaded liner, your measurement will be incorrect.

STEP B: Measure from the bead track (beaded hung liners) or from top of the pool (overlap hung liners) down to where the cove (T) begins. Subtract (T) from (C) to determine (U).

STEP C: With a pole, locate the spot where the cove meets the floor. Use a carpenter's level to verify that the pole is vertical. Measure from the **pool wall to the pole to determine (V).**

STEP D: If the cove along the sidewall differs from the end wall cove, please notate on separate paper and include with the measuring form.

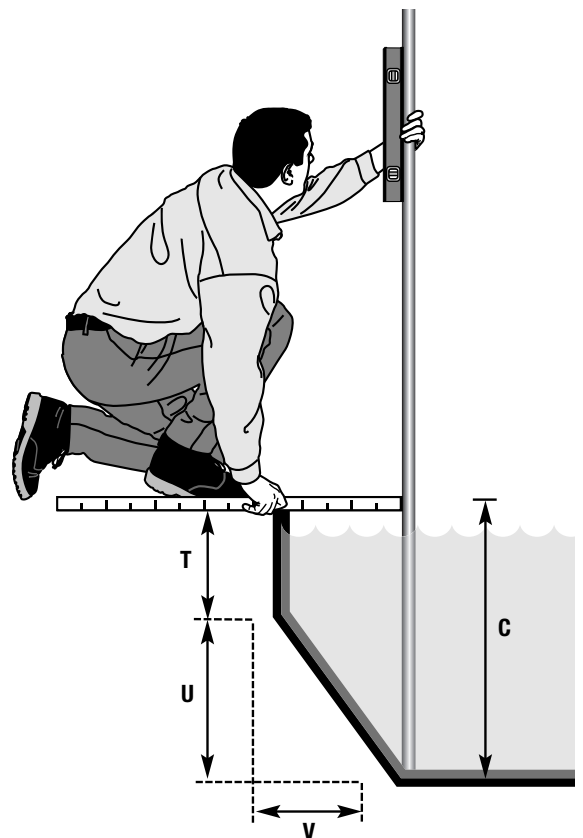

TIP! Be sure that (V) is a Horizontal Measurement, Do Not Measure the Slope of the Cove.

We only use measurements parallel to the deck. See the diagrams to the right for the correct way to measure a covered bottom.

RIGHT!

WRONG!

DIAGRAM 6: HORIZONTAL MEASUREMENTS OF POOL BOTTOM & DEPTH MEASUREMENTS

BOTTOM CONTOUR

Choose the Bottom Contour of your pool from Illustration D below to determine which measurements you will need to take.

How do I measure the bottom of my pool?

You will be able to make horizontal measurements of your pool bottom without entering the pool. Taking these measurements is easier than you may think, when you use this easy-to-make measuring tool.

You will need:

1. A long straight pole (telepole)
2. String attached to one end of the pole
3. Some sort of weight tied to the other end of the string
4. A measuring tape

Indicate the Bottom Contour & measurements of your pool on Page 1 of the Measuring Form.

Follow the instructions below, using your fishing pole, to make these measurements.

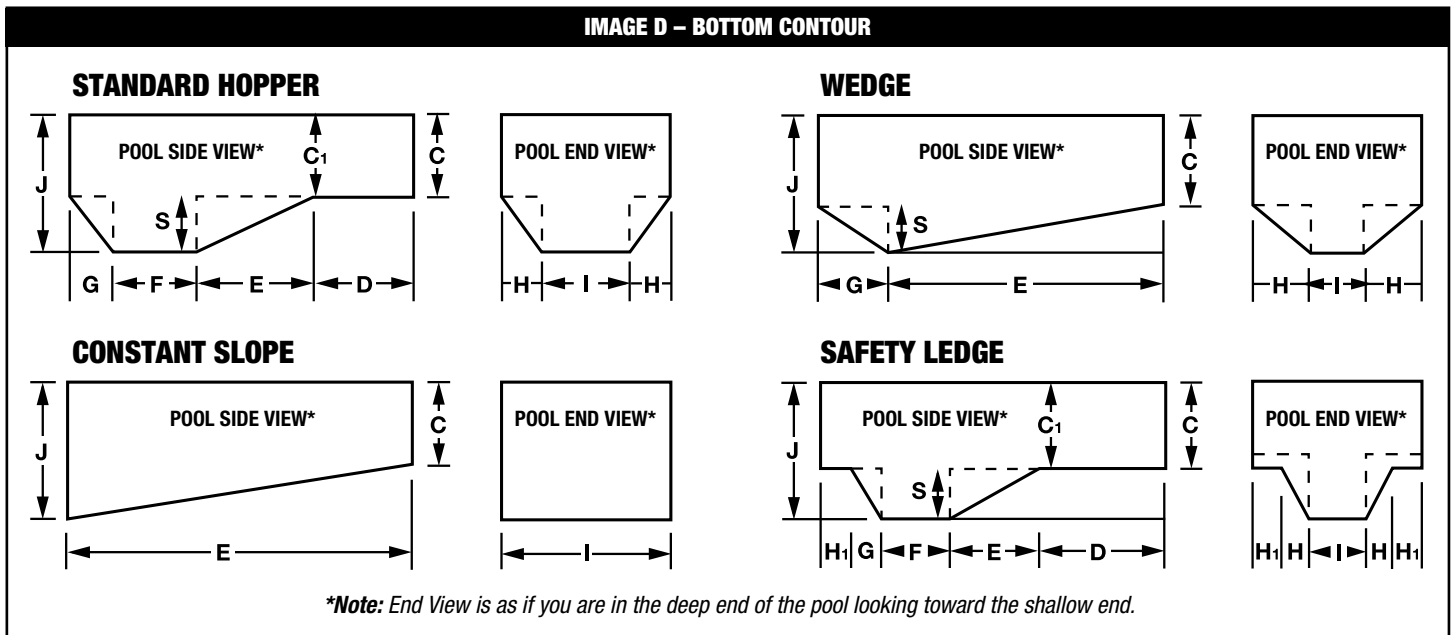

Horizontal Bottom Measurements: Use your “fishing pole” to “fish” for a point on the bottom of the pool. With the pole parallel to the ends of the pool and the string vertical (allow no slack in the string), measure the distance from the edge of the pool (water’s edge) to the end of the pole where string is attached. You should “fish” for points that will achieve the desired measurements based on the bottom contour of your pool (pictured above). For example, to take measurement (H), you would stand on one side of the pool, and “fish” for a corner of the Hopper. You would then measure the distance from the edge of the pool (water’s edge) to the end of the pole where the string is attached.

Depth Measurements: When taking the depth measurements (C) and (J), be sure to measure from the bottom of the pool floor to the bead receiver (for beaded liners) OR to the to board where the liner is nailed or stapled (for overlap liners). Do not measure to the top of the pool if you have a bead receiver, your measurement will be incorrect

QUICK CHECK

C + S must equal J

Note: S is a difficult measurement to take unless you are inside the pool. It is not necessary to measure S; it is used mainly as a cross-check to verify measurement J.

D + E + F + G must equal A for a Standard Hopper

(A is the length of pool taken in Step #4)

E + G must equal A for a Wedge

(A is the length of pool taken in Step #1)

D + E + F + G + H1 must equal A for a Safety Ledge

(A is the length of pool taken in Step #4)

H + I + H must equal B for Standard Hopper and Wedge

(A is the length of pool taken in Step #4)

H1 + H + I + H + H1 must equal B for Safety Ledge

(B is the width of pool taken in Step #4)

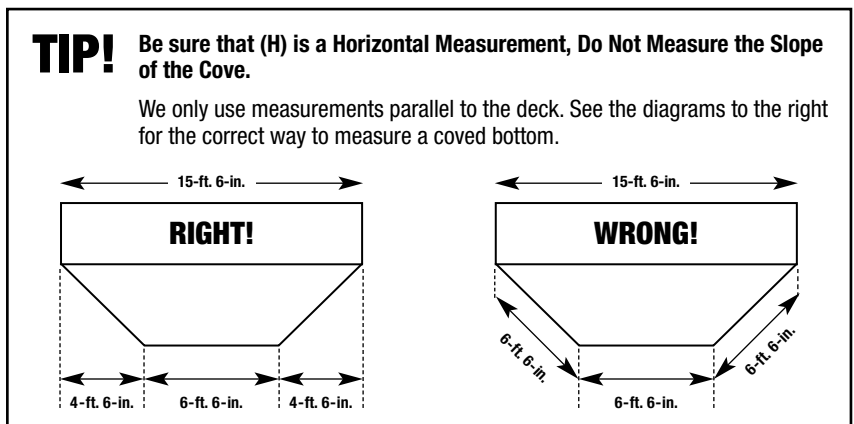

LESLIE'S LINER MEASURING FORM

PHONE: 800-537-5437 • FAX: 866-298-0173

www.lesliespool.com • Email: customforms@lesl.com

Name: _____ Email Address: _____

Address: _____ City: _____ State: _____ Zip Code: _____

Daytime Phone: () _____ Evening Phone: () _____

Fax: () _____ Source Code (In the blue box on the back of your catalog): _____

1. LINER TYPE: (See Measuring Instructions Step 1)

- BEADED**
 - STANDARD BEADED
 - SPECIAL BEADED _____
- LOW HUNG BEADED**
- OVERLAP**
How many inches of liner do you need for the overlap? _____

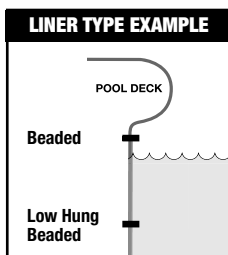

2. VINYL COVERED STEP SECTIONS:

(See Measuring Instructions Step 9)

- If you have a step section that is covered by the vinyl liner, check this box. You must also complete the reverse side of this measuring form, "Page 2" and fax or mail it with this page.

3. LINER PATTERN: (See Measuring Instructions Step 10)

If you would like to receive quotes on more than one pattern, please list both patterns and gauges below. **Note: Overlap liners Do Not have a tile border.**

PATTERN NAME: _____

PATTERN NAME: _____

4. POOL SHAPE: (See Measuring Instructions Step 2)

Enter the **Pool Shape** you selected from **Diagram 3**: _____

On the line below enter the **Manufacturer** or **Brand Name** of pool (if available):

5. CORNER TYPE: (See Measuring Instructions Step 3)

Please indicate your corner type below. If your corners are Radius (rounded) or Cut (diagonal), enter the measurements below. (Refer to Diagram 4 for instructions on how to measure corners).

- CUT CORNERS** (Diagonal, Point 1 to Point 2: _____ inches)
- RADIUS CORNERS** (Rounded, Point 1 to Point 2: _____ inches)
- 90 DEGREE CORNERS** (Square, No measurement needed)

SUBMIT FORM: Submitting this measuring form indicates you have verified your measurements and the information you have provided is correct. Your new liner will be made to these specifications once your order is placed.

6. DIMENSIONS: (See Measuring Instructions Steps 4-8)

Please transfer all of the measurements you have taken into the appropriate spaces below. **Note: you may not use all the letters below, depending on your pool shape.**

- | | |
|-------------------------|-------------------------|
| A. _____ ft. _____ in. | Q. _____ ft. _____ in. |
| B. _____ ft. _____ in. | R. _____ ft. _____ in. |
| C. _____ ft. _____ in. | S. _____ ft. _____ in. |
| C1. _____ ft. _____ in. | T. _____ ft. _____ in. |
| D. _____ ft. _____ in. | U. _____ ft. _____ in. |
| E. _____ ft. _____ in. | V. _____ ft. _____ in. |
| F. _____ ft. _____ in. | W. _____ ft. _____ in. |
| G. _____ ft. _____ in. | X. _____ ft. _____ in. |
| H. _____ ft. _____ in. | A1. _____ ft. _____ in. |
| H1. _____ ft. _____ in. | A2. _____ ft. _____ in. |
| I. _____ ft. _____ in. | A3. _____ ft. _____ in. |
| J. _____ ft. _____ in. | A4. _____ ft. _____ in. |
| K. _____ ft. _____ in. | B1. _____ ft. _____ in. |
| L. _____ ft. _____ in. | B2. _____ ft. _____ in. |
| M. _____ ft. _____ in. | Z1. _____ ft. _____ in. |
| N. _____ ft. _____ in. | Z2. _____ ft. _____ in. |
| O. _____ ft. _____ in. | Z3. _____ ft. _____ in. |
| P. _____ ft. _____ in. | Z4. _____ ft. _____ in. |

7. LINER TYPE: (See Measuring Instructions Step 7)

Please verify measurements.

- | | | |
|---|---------------------------|-------------------------------------|
| <input type="checkbox"/> STANDARD HOPPER | $G + F + E + D = A$ | <input type="checkbox"/> YES |
| | $H + I + H = B$ | <input type="checkbox"/> YES |
| <input type="checkbox"/> CONSTANT SLOPE | $E = A$ | <input type="checkbox"/> YES |
| | $I = B$ | <input type="checkbox"/> YES |
| <input type="checkbox"/> WEDGE | $G + E = A$ | <input type="checkbox"/> YES |
| | $H + I + H = B$ | <input type="checkbox"/> YES |
| <input type="checkbox"/> SAFETY LEDGE | $H1 + G + F + E + D = A$ | <input type="checkbox"/> YES |
| | $H1 + H + I + H + H1 = B$ | <input type="checkbox"/> YES |

LESLIE'S LINER MEASURING FORM

PHONE: 800-537-5437 • FAX: 866-298-0173

www.lesliespool.com • Email: customforms@lesl.com

VINYL COVERED STEPS: *(Complete this page only if you have steps that will be covered by the liner.)*

Name: _____ Email Address: _____

Phone: () _____ Fax: () _____

1. WHAT TYPE OF BACK CORNERS?

This refers to the corner at the back of the stair on the top riser as indicated in the **Step Section**. Images on the right will help determine the type of corners on your pool. Use the space provided to record your measurement.

CUT CORNERS (Diagonal)
Point 1 to Point 2: _____ inches

Measure the distance from point (1) to point (2)

RADIUS CORNERS (Rounded)
Point 1 to Point 2: _____ inches

Measure the distance from point (1) to point (2). Continue the side wall of the pool to create an imaginary corner.

90 DEGREE CORNERS (Square)
No measurement needed

90° (Square)
No measurements required.

2. IS THE STEP FLUSH OR RECESSED?

If the bottom riser is flush with the wall indicated in the **Step Section**, check the **Flush** option. If not, the type and size of corner must be provided. (see **Recessed Corner**)

DIAGONAL RECESSED STEP
Measurement: _____

Measure the **Diagonal Recess Step** between the bottom step and pool wall.

STRAIGHT RECESSED STEP
Measurement: _____

Measure the **Straight Recess Step** between the bottom step and pool wall.

FLUSH STEP
No measurement needed

The step is **Flush**, No measurements are needed

3. STEP SECTION

Record all the measurements in the boxes provided. Measure the **Height** of the risers and the **Depth** of the treads. To check your measurements, verify that the sum of all the **Riser Heights** equals the **Wall Height (WH)**. Also, verify that the sum of all the **Tread Depths** equals the **Total Step Section Depth (D)**.

STEP SECT. MEASUREMENTS	
W	
D	
WH	
R1	
R2	
R3	
R4	
T1	
T2	
T3	
X	
Y	

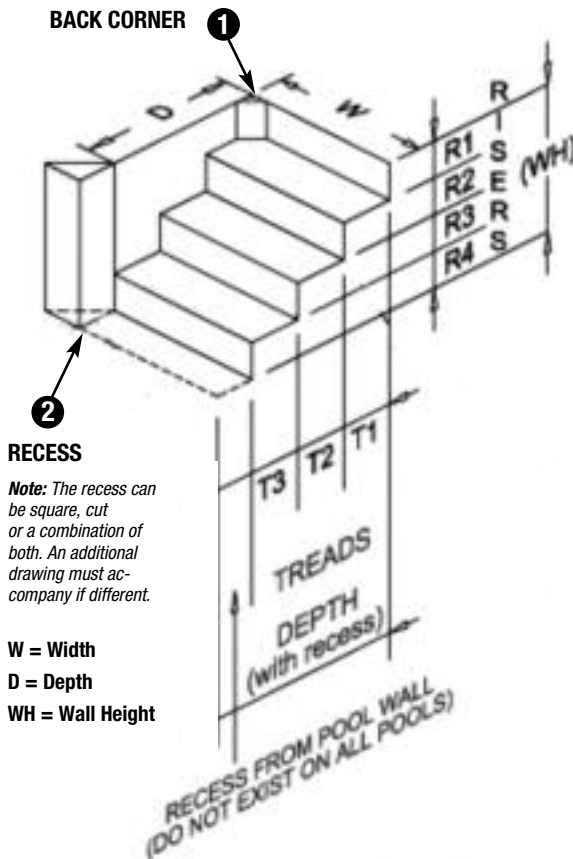

4. WHAT IS THE STEP POSITION?

Please circle the position that best describes the location of your steps. **Please circle only one.** Provide the measurements (X) and (Y) in the **Step Section Measurements** column.

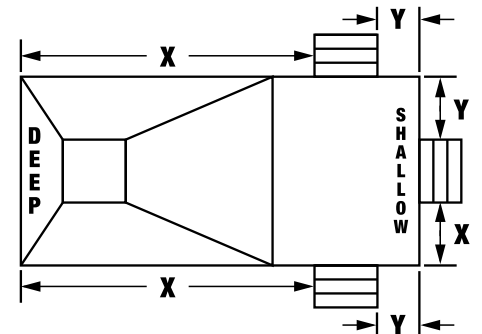

Note: If step is at edge, then (Y) is zero.

5. DO YOU REQUIRE LOOPS?

Do you require loops to secure stairs with rods? (select only one)

YES NO

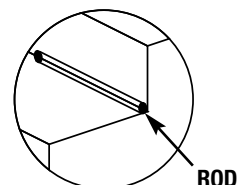

ALL STEP MEASUREMENTS MUST BE HORIZONTAL & VERTICAL. MEASURE TO THE NEAREST 1/8"