



**COMMERCIAL
FIBERGLASS DIVING BOARD
Assembly & Installation Instructions**



IMPORTANT NOTICE TO INSTALLERS:

This commercial diving board is rated for commercial/public pools including Class B and Class C pools.

Please refer to the excerpts from the ANSI/NSPI-1 2003 American National Standard for Public Swimming Pools to verify compliance with pool type and installation requirements.

**3050 S. ALVERNON WAY • TUCSON, AZ 85713
520.790.7040 • 800.737.5386 • FAX 520.790.7127**

inter-fab.com

For Technical Support or Assistance,
Contact Customer Service at:

**INTER-FAB, INC.
3050 S. ALVERNON WAY
TUCSON, AZ 85713
(800) 737-5386**

or visit: www.inter-fab.com

To obtain complete copies of the ANSI/NSPI-1 2003
American National Standard For Public Swimming
Pools or to obtain copies of the "Plan Your Dive,
Steer Up" brochure contact:

**The Association of Pool & Spa Professionals
(APSP)
2111 Eisenhower Ave.
Alexandria, VA 22314
(703) 838-0083**

or visit: www.apsp.org

TABLE OF CONTENTS:

Safety First2

Intended Use Instructions3

Important Notices to the Installer.....4

Commercial Board Dimensions & Fulcrum Settings5

Commercial Board Mounting Diagram5

Inter-Fab Public Pool Specifications.....6

Installation Instructions6

Article 5 Extracted from ANSI/NSPI-5 20037-15

Page for Notes.....16

Inter-Fab Limited Warranty.....17

SAFETY FIRST!

This Inter-Fab commercial diving board shall be installed only by a professional swimming pool contractor or with the direct supervision of a licensed professional, engineer or architect. Commercial diving boards may be installed only on public inground swimming pools properly designed for their use.

Diving boards that are improperly installed can be very dangerous to the user resulting in possible serious head and/or spinal column injury, including the paralysis or death of the user.

It is very important that this diving board and stand be installed only on Type VI – Type IX pools built in strict accordance with the American National Standard for Public Swimming Pools (ANSI/NSPI-1 2003) and in accordance with the included INTER-FAB PUBLIC POOL SPECIFICATIONS Table 3 on page 6.

In addition to the above standard and referenced table, these installation instructions provided by Inter-Fab, Inc. must be diligently followed.

It is also important that any and all warnings provided with the diving board be strictly adhered to and posted in a conspicuous location. If not provided or they are misplaced, please purchase warning signs from your pool contractor or professional pool supply store and post them in a location that the users of the diving board can clearly see.

FOR PUBLIC INGROUND SWIMMING POOL USE ONLY

**ONLY ONE PERSON ON THE DIVING BOARD AT ONE TIME
MAXIMUM WEIGHT = 250 LBS**

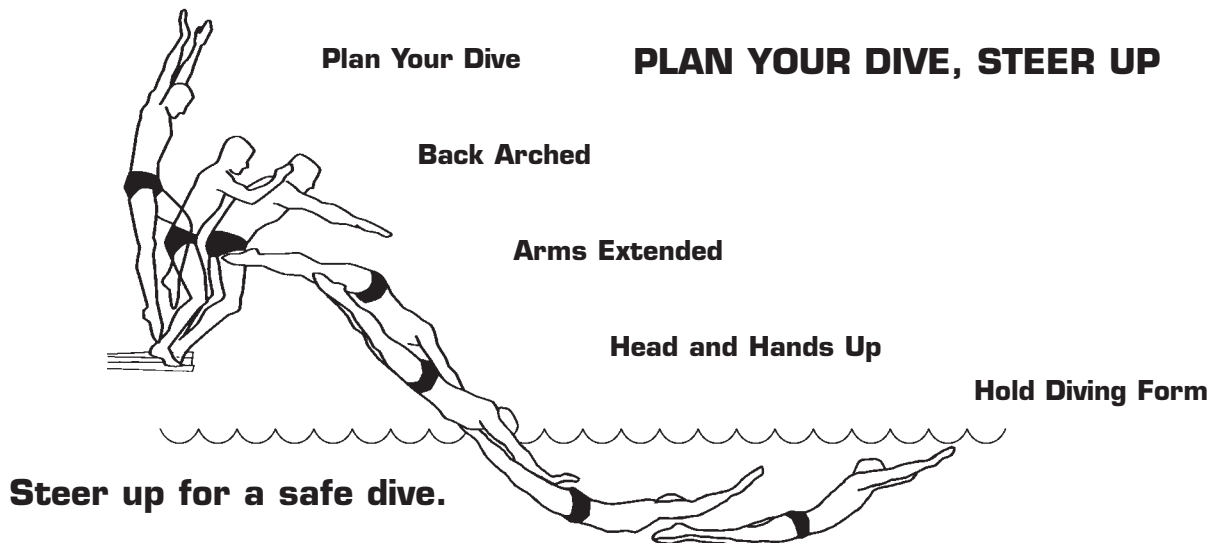

DIVING TIPS: Even the safest equipment must be used properly. Inter-Fab promotes safe diving by offering these tips on the proper use of your diving board: always dive into water that meets depth requirements, with arms extended; be aware of the bottom and the walls of the pool; avoid collisions with pool toys and floats; and instruct your pool users to always “steer up”. When you begin your dive you must get ready to steer up. As you enter the water, your arms must be extended over your head, hands flat aiming up. Hold your head and arch your back.

INTENDED USE INSTRUCTIONS

“A pool is the safest place to swim and a diving board installed in compliance with manufacturer’s instructions and the ANSI/NSPI-1 2003 Standard for Public Swimming Pools is the safest place to dive from. To ensure that you and your guests are able to safely enjoy your diving board for many years, it is critical that you follow the following instructions.”

DO

1. Know the shape and depth of the pool before you dive.
2. Make sure that all family members and guests are familiar with these instructions before they use your pool and diving board.
3. Make sure that the diving board has been installed in compliance with the Assembly and Installation Instructions and with the ANSI/NSPI-1 2003 Standard for Public Swimming Pools. This includes the shape and depth of the pool as well as the height of the diving board.
4. Enter feet first the first time.
5. Plan your path to be sure you avoid any other swimmers, or objects in or under the water, such as floats, tires, toys etc.
6. Keep your head up, arms up and fully extended and **steer up** with your hands.
7. Practice carefully before you dive headfirst.
8. Become familiar with the diving board and its spring before diving headfirst
9. Dive straight ahead, not to the side of the board or pool.
10. Dive from the diving board only.
11. Make sure that children and non-swimmers are supervised at all times.
12. Always remember that when you dive you **must steer up**.
13. Inspect your diving board, base and stand on a regular basis (at least twice a year) and keep them in proper repair.
14. Contact your dealer, installer or Inter Fab (800-737-5386) with any questions or concerns about the safe use of your diving board.

DON'T

1. Don't drink and dive.
2. Don't install this or any diving board on an above ground pool or dive into an above ground pool from any surface.
3. Never install any Inter-Fab diving board on a variable fulcrum dive stand.
4. Don't dive into a pool from anyplace not specifically designated for diving. Never dive into the shallow portion of any pool.
5. Don't dive across the width of the pool or to the sides of the pool.
6. Don't Run and dive.
7. Don't engage in horseplay in or around the diving board or pool.
8. Don't use your diving board as a trampoline.
9. Don't do a back dive. Backyard pools are not built for that type of activity.
10. Don't try fancy dives. Keep the dives simple.
11. Don't dive into or through objects or toys such as inner tubes.
12. Don't swim or dive alone.
13. Don't use a diving board or stand or base that is rusted or worn out or in poor repair.

IMPORTANT NOTICES TO THE INSTALLER

The specifications found on pages 7-15 of this manual represent the minimum water envelope required by Inter-fab and by the ANSI/NSPI-1 2003 Standard for Public Swimming Pools. Each of these dimensions must be met or exceeded. Installation of a diving board of any type on a pool that does not meet or exceed each of the minimum specifications as provided on pages 7-15 including but not limited to the slope requirement, is in direct violation of this manufacturer's instructions and the 2003 Standard, and can result in serious injury or death.

Installation of this commercial diving board is limited to Class B & C, Type VI – IX Inground Pools only.

The tip of the diving board must be positioned directly over Pt. A as shown on Figure 1 – Construction Dimensions for Water Envelopes for Class B and Class C Pools per the ANSI/NSPI-1 2003 standard.

Inter-Fab Commercial Diving Boards are designed for use on passive dive stands. Installation on any spring stand is strictly prohibited.

Inter-Fab Commercial Diving Boards are designed for use on dive stands 2/3 – 3 meters in height in strict accordance with Table 3 – Inter-Fab Public Pool Specifications. In no circumstance may any Inter-Fab commercial diving board be installed on a dive stand higher than 3 meters.

Comply with local government regulations for Public Swimming Pools if they exceed the ANSI/NSPI-1 2003 Standard for Public Swimming Pools.

If installing this commercial diving board on another manufacturer's dive stand bolt it to the stand per that manufacturer's instructions.

The Concrete Deck Around the Dive Stand Jig must be a Minimum of 6" thick.

When installing this commercial diving board to a fixed fulcrum dive stand you must ensure the board is mounted with the correct distance from the board mounting bolt holes to the fulcrum. See TABLE 1- Board Dimensions and Fulcrum Settings on page 5.

Read carefully pages 7–15 of this installation manual which contain portions of the ANSI/NSPI-1 2003 Standard for Public Swimming Pools, ensure that you understand Figure 1 and Table 2 provided in the ANSI/NSPI-1 2003 Standard on pages 10 and 11.

NOTE: The installation of this commercial diving board is not complete until you, the installer have measured the pool as well as the diving board's height above water and the fulcrum distance to ensure they meet the Inter-Fab Public Pool Specifications and the ANSI/NSPI-1 2003 Standard for Public Swimming Pools. In addition; the installation of this diving board is not complete until you the installer have delivered to your customer and reviewed with your customer the "Owners Manual" as well as the "Plan Your Dive Steer-Up" brochure.

The Diving Board must be installed according to the below board leveling instructions on page 6.

**ONLY ONE PERSON AT A TIME ON THE DIVING BOARD,
WITH A MAXIMUM WEIGHT LIMIT OF 250 LBS.**

FIG. A - COMMERCIAL BOARD

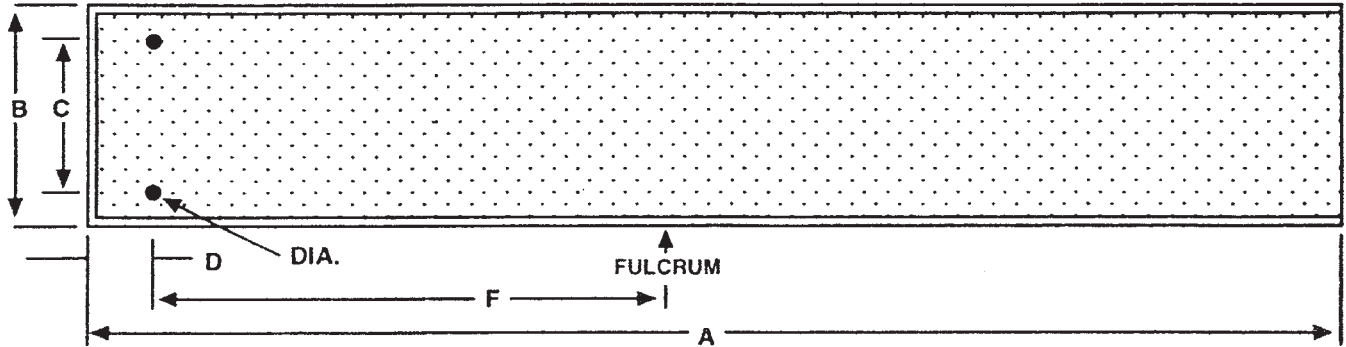
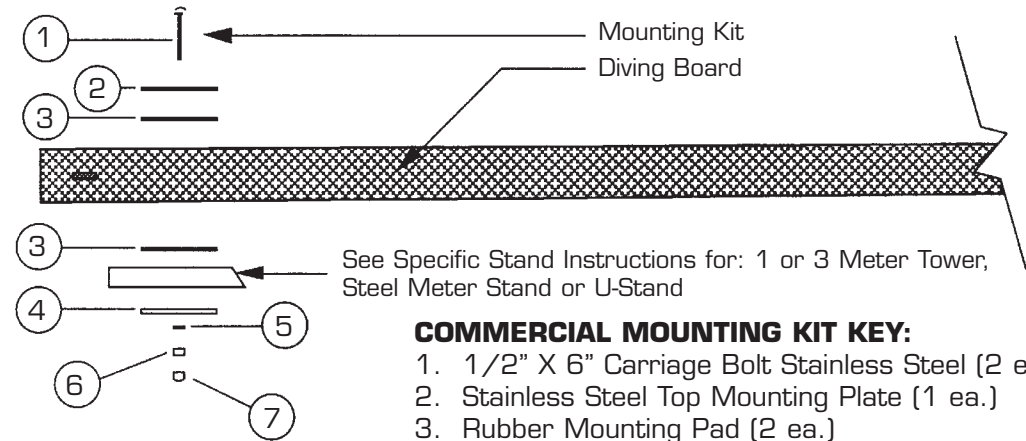

TABLE 1 - BOARD DIMENSIONS AND FULCRUM SETTINGS

Model #	Nominal Length	A	B	C	D	F	DIA.
COM10	10'	117.50"	17.50"	12.00"	4.00"	52.00" ±5"	19/32"
COM12	12'	142.00"	17.50"	12.00"	4.00"	62.00" ±6"	19/32"
COM14	14'	166.00"	20.00"	12.00"	4.00"	74.00" ±6"	19/32"
COM16	16'	190.00"	20.00"	12.00"	4.00"	86.00" ±6"	19/32"

FIG. B - BOARD MOUNTING DIAGRAM



HARDWARE NOTE:
Use a small dab of anti seize lubricant (included) on all bolt threads.

NOTE: Tighten Hex Nuts Between 20-25 FT/LBS. **DO NOT OVER TIGHTEN.**

COMMERCIAL MOUNTING KIT KEY:

1. 1/2" X 6" Carriage Bolt Stainless Steel (2 ea.)
2. Stainless Steel Top Mounting Plate (1 ea.)
3. Rubber Mounting Pad (2 ea.)
4. Bottom Mounting Plate (1 ea.)
5. 1/2" Lock Washer C/S Stainless Steel (2 ea.)
6. 1/2" Hex Nut C/S Stainless Steel (2 ea.)
7. 1/2" White Rubber Bolt Cap (2 ea.)

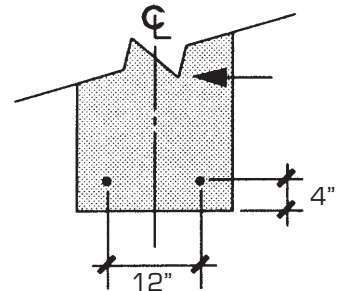

TABLE 2 - COMMERCIAL FIBERGLASS DIVING BOARD SPECIFICATIONS:

	10' BOARD	12' BOARD	14' BOARD	16' BOARD
Fulcrum Setting from Bolt Holes	52"	62"	74"	86"
Thickness / Heel	1.5"	1.75"	2.25"	2.25"
Thickness / Toe	1.25"	1.25"	1.75"	1.75"
Length	118.5"	142.5"	167"	190"
Width	17.5"	17.5"	20"	20"
Bolt Holes: Center to Center	12"	12"	12"	12"
from Rear	4"	4"	4"	4"
Fulcrum Tolerance +/-	5"	6"	6"	6"

TABLE 3 - INTER-FAB PUBLIC POOL SPECIFICATIONS

POOL TYPE	RELATED DIVING EQUIPMENT		Placement of boards shall observe the following minimum dimensions. With multiple board installations, minimum pool widths must be increased accordingly.
	MAX. DIVING BOARD LENGTH	MAX. BOARD HEIGHT OVER WATER	
VI	10'	(2/3 Meter) 26"	<ul style="list-style-type: none"> • Deck Level Board to Pool Side 8' • 1 Meter Board to Pool Side 10' • 3 Meter Board to Pool Side 11'
VII	12'	(3/4 Meter) 30"	<ul style="list-style-type: none"> • 1 Meter or Deck Level Board to 3 Meter Board 10' • 1 Meter or Deck Level Board to Another 1 Meter or Deck Level Board 8'
VIII	16'	1 Meter	<ul style="list-style-type: none"> • 3 Meter to Another 3 Meter Board 10'
IX	16'	3 Meter	

Commercial Fiberglass Diving Board INSTALLATION INSTRUCTIONS

1. When mounting a diving board to a newly installed stand with a permanently fixed fulcrum, the correct measurement between the mounting holes and the fulcrum must be maintained so as not to void the warranty. (See Table 2 - Commercial Fiberglass Diving Board Specifications.)
2. Tighten hex nuts between 20-25 ft.-lbs. for fiberglass boards. **DO NOT OVER-TIGHTEN.**
3. ONLY ONE PERSON ON DIVING BOARD AT A TIME.
4. MAXIMUM WEIGHT LIMIT = 250 LBS.

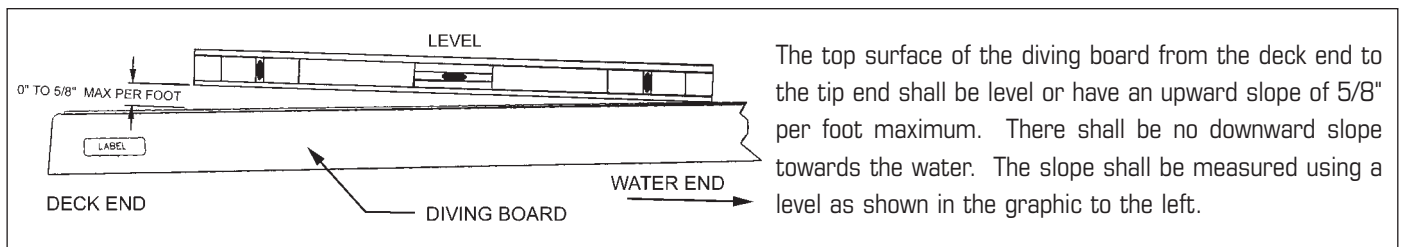

**ONLY ONE PERSON AT A TIME ON THE DIVING BOARD,
WITH A MAXIMUM WEIGHT LIMIT OF 250 LBS.**

SUPPORT INFORMATION: ARTICLES 1-7

Extracted from ANSI/NSPI-1 2003, American National Standard for Public Swimming Pools

ANSI/NSPI-1 2003

Standard for Public Swimming Pools

1 Scope

1.1 Public swimming pools. This standard covers public swimming pools to be used for bathing and operated by an owner, licensee, or concessionaire, regardless of whether a fee is charged for use.

1.1.1 Public swimming pools covered by this standard. Public swimming pools covered by this standard include Class A pools (pools used for competitive aquatic sports), Class B and Class C pools, (pools intended for public or semi-public recreational swimming), and Class F pools (for wading). (See article 3 for definitions.)

1.2 Variation in design. This standard provides specifications for the design, equipment, operation, warning signs, installation, sanitation, new construction, and renovation of public swimming pools. This standard permits variations in equipment, materials, and design to accommodate special needs and considerations and advances in technology and to provide the required quality, strength, durability, and safety for the intended use.

1.3 Renovation. (See appendix H, Glossary.) Renovation does not include ordinary maintenance. Only those items that are renovated shall adhere to this standard.

2 Normative references

The following standards contain provisions that, through reference in this text, constitute provisions of this American National Standard. At the time of publication, the editions indicated were valid. All standards are subject to revision, and parties to agreements based on this American National Standard are encouraged to investigate the possibility of applying the most recent editions of the standards indicated below.

ANSI/ASME A112.19.8M-1987 (1996), *Suction fittings for swimming and wading pools, spas, hot tubs, and whirlpool bathtub appliances*¹

ANSI/ICC A117.1 (2003), *Standard on accessible and useable buildings and facilities*²

ANSI/NEMA-MG1-1998, *Motors and generators*³

ANSI/NSF 14 (2003), *Plastics piping system components and related materials*⁴

ANSI/NSF 50 (2001), *Circulation system components and related materials for swimming pools, spas/hot tubs*⁵

ANSI Z21.56-2001/CSA 4.7-2001, *Gas fired pool heaters*⁶

ACI 302.1R-96 (1996), *Guide for concrete floor and slab construction*⁷

Americans with Disabilities Act (ADA) *Accessibility guidelines for buildings and facilities; recreation facilities*⁸

ASME A112.1.2 (2002), *Air gaps in plumbing systems*⁹

ASTM 1346-91 (2003), *Standard performance specification for safety covers and labeling require-*

¹American National Standards Institute (ANSI), 25 West 43rd Street, New York, NY 10036, NY (212) 642-4900, www.ansi.org

²ANSI, previously listed

³National Electrical Manufacturers Association (NEMA), 1300 N. 17th Street, Suite 1847, Rosslyn, VA 22209 (703) 841-3200, www.nema.org

⁴NSF International, 789 N. Dixboro Rd., Ann Arbor, MI 48113 (734) 769-8010, www.nsf.org

⁵NSF, previously listed

⁶ANSI, previously listed

⁷American Concrete Institute, 38800 Country Club Drive, Farmington Hills, MI 48331, (248) 848-3800, www.aci-int.org

⁸U.S. Architectural and Transportation Barriers Compliance Board, 1331 F Street, NW, Suite 1000, Washington, DC 20004, (202) 272-0080, www.access-board.gov

⁹American Society of Mechanical Engineers (ASME), 3 Park Avenue, 20th Floor, New York, NY 10016, (212) 591-8562, www.asme.org

SUPPORT INFORMATION: ARTICLES 1-7

Extracted from ANSI/NSPI-1 2003, American National Standard for Public Swimming Pools

*ments for all covers for swimming pools, spas and hot tubs*¹⁰

ASTM F2208-02, *Standard specification for pool alarms*¹¹

ANSI/NFPA 54-2002, *National fuel gas code*¹²

ANSI/NFPA 70-2002, *National electric code*¹³

UL 1995 (1999), *Standard for heating and cooling equipment*¹⁴

UL 1261 (2001), *Standard for electric water heaters for pools and tubs*¹⁵

3 Definitions

Public swimming pools are classified as follows for purposes of reference and application of this standard:

Class A pools - Class A pools are pools intended for use for accredited competitive aquatic events such as Federation Internationale de Natation (FINA), U.S.A. Swimming, U.S. Diving, National Collegiate Athletic Association (NCAA), National Federation of State High Schools Associations (NFSHSA), etc. The pool may also be used for recreation. Class A pools are covered unless otherwise noted in the body of the standard.

Class B pools - Class B pools are pools intended for public recreational swimming not otherwise classified. Class B pools are covered within the scope of this standard.

Class C pools - Class C pools are pools intended for use for apartments, condominiums, property owners associations, multi-family owned pools, etc. and are

¹⁰ ASTM International, 100 Barr Harbor Drive, W. Conshohocken, PA 19428, (610) 832-9585, www.astm.org

¹¹ ASTM, previously listed

¹² National Fire Protection Association (NFPA), 1 Batterymarch Park, Quincy, MA 02269 (617) 770-3000, www.nfpa.org

¹³ NFPA, previously listed

¹⁴ Underwriters Laboratories (UL), 333 Pfingsten Road, Northbrook, IL 60062, (847) 272-8800, www.ul.com

¹⁵ UL, previously listed

covered within the scope of this standard. Pools operated solely for and in conjunction with lodgings such as hotels and motels are also covered within the scope of this standard.

Class D pools - Class D pools are not covered within the scope of this standard. Class D pools are operated for special purposes, including but not limited to wave action pools, activity pools, leisure rivers, vortex pools, and sand bottom pools.

Class E pools - Class E pools are pools used for physical therapy and are above 86 °F (30 °C) and are not covered within the scope of this standard.

Class F pools - Class F pools are wading pools and are covered within the scope of this standard as set forth in 6.9 and 8.4.2 and as noted in other sections of the standard.

4 Code compliance

4.1 Codes. Pools covered by this standard shall be constructed and operated to comply with all local, state, and federal codes governing safety and environmental regulations.

5 General design

5.1 Plans and permits. Prior to construction, rehabilitation, or alteration of a permanently installed public swimming pool, plans and specifications shall be submitted to the authority (state or local) for review, approval, and issuance of a permit to construct or rehabilitate as required by the authority having jurisdiction.

5.2 Materials. Swimming pools and all appurtenances thereto shall be constructed of materials that are nontoxic to humans and the environment; that are generally or commonly regarded to be impervious and enduring; that will withstand the design stresses; and that will provide a watertight structure with a smooth and easily cleaned surface without cracks or joints, excluding structural joints, or to which a smooth, easily cleaned surface/finish is applied or attached.

5.2.1 Selection of materials. Clean sand or similar material, if used in a beach pool environment, shall be used only over an impervious surface. The

SUPPORT INFORMATION: ARTICLES 1-7

Extracted from ANSI/NSPI-1 2003, American National Standard for Public Swimming Pools

sand area shall be designed and controlled so that the circulation system, maintenance, safety, sanitation, and operation of the overall pool are not adversely affected.

5.3 Structural design. The structural design shall be in accordance with accepted engineering practices.

5.4 Freeze protection. In climates subject to freezing temperatures, the pool shell and appurtenances, piping, filter system, pump and motor, and other components shall be designed and constructed to facilitate protection from damage due to freezing.

5.5 Surface condition. The surfaces within the pool intended to provide footing for users shall have a slip-resisting surface and shall not cause injury to the feet during normal use.

5.6 Colors and finishes. The colors, patterns, or finishes of the pool interior shall not obscure objects or surfaces within the pool.

5.7 Accessibility for persons with disabilities. For Americans with Disabilities Act (ADA) requirements for accessibility for persons with disabilities into public swimming pools, see *ADA Accessibility guidelines for buildings and facilities, recreation facilities* (ADAAG).

6 Dimensional design

6.1 Perimeter shape. This standard is not intended to regulate the perimeter shape of swimming pools. It is the designer's responsibility to take into

account the effect a given shape will have on the safety of the occupants and required circulation to ensure sanitation. All other dimensions, unless otherwise specified, should allow a ± 2 inches (51 mm) tolerance.

6.1.1 There shall be no protrusions, extensions, means of entanglement, or other obstructions in the swimming pool areas that may cause the entrapment or injury of the user.

6.2 Allowable construction tolerances. These construction tolerances are not applicable to Class A pools.

6.2.1 Finished pool dimensions shall be held within the following construction tolerances as shown in table 1.

6.3 Floor slope. Floor slopes shall be in compliance with 6.3.1 through 6.3.5, except the requirements by the ADA Accessibility guidelines (ADAAG).

6.3.1 All pool floors shall be sloped to the drain.

6.3.2 The slope of the floor in the shallow area shall not exceed 1 foot in 10 feet in Class C pools or 1 foot in 12 feet in Class B pools in any direction to the point of the first slope change, if a slope change exists.

6.3.3 The point of the first slope change shall be defined as the point at which the floor slope exceeds 1 foot in 10 feet in Class C pools or 1 foot in 12 feet in Class B pools.

Table 1 – Construction tolerances

Design requirements	Construction tolerance allowed
Length - overall	± 3 in. (76 mm)
Width - overall	± 3 in. (76 mm)
Depth - deep area, including diving area	± 3 in. (76 mm)
Depth - shallow area	± 2 in. (51 mm)
Step treads & risers	$\pm 1/2$ in. (13 mm)
Waterline - pools with adjustable weir skimmers	$\pm 1/4$ in. (6 mm)
Waterline - pools with nonadjustable skimming systems (gutters)	$\pm 1/8$ in. (3 mm)
Wall slopes	± 3 degrees
All dimensions not otherwise specified in this standard	± 2 in. (51 mm)
Competitive pools - Class A pools - All dimensional requirements	As governed by sanctioning authority

SUPPORT INFORMATION: ARTICLES 1-7

Extracted from ANSI/NSPI-1 2003, American National Standard for Public Swimming Pools

6.3.4 The slope of the floor from the point of the first slope change to the deep area shall not exceed 1 foot in 3 feet.

6.3.5 Walls. Where walls join the floor the transitional point or profile shall comply with the following:

- Walls may intersect with the floor at an angle or a transition profile.
- At water depths between 3 feet to 5 feet (91 cm to 152 cm) the maximum radius shall be 2 feet 3 inches (69 cm).
- At water depths of 3 feet (91 cm) or less a transitional radius shall not exceed 6 inches (15 cm) and shall be tangent to the wall and may be tangent to or intersecting the floor.
- At water depths greater than 3 feet (91 cm) a transitional radius shall be tangent to the wall at a point no less than 2 feet and 6 inches (76 cm) below the water surface and may progressively increase from 6 inches (5 cm) to a value capable of being tangent to or intersecting the floor.

6.4 Water depths. Water depths for swimming areas shall be a minimum depth of 3 feet (91 cm) unless the authority having jurisdiction specifies otherwise.

6.4.1 Class A pools shall be designed and constructed to provide the dimensions specified by Federation Internationale de Natation (FINA), U.S.A. Swimming, U.S. Diving, or other appropriate sanc-

tioning body. (See appendix H, Glossary for the definition of pools, Commercial/Public Pool: Class A)

6.5 Diving. This standard does not cover diving requirements for Class A pools. This standard covers diving requirements for Class B and Class C pools. (See appendix H, Glossary.)

6.5.1 When diving equipment is installed, it shall conform to the specifications set forth in 7.2.1 through 7.2.5.6. Equipment shall be located in the diving area of the pool on the appropriate ANSI/NSPI pool type (or other water envelopes specified by the diving equipment manufacturer) in accordance with the manufacturer’s installation instructions and the minimum dimensions as shown in figure 1. Competitive diving equipment shall not be installed on Class B and Class C pools.

6.6 The manufacturer of the diving equipment shall specify minimum water envelopes for its products. They may refer to the water envelope type of their choice by dimensionally relating their products to Point “A” on that water envelope. Point “A” as shown in figure 1 is designated as the point of origin on the water surface for the water envelope dimension.

6.6.1 Point A is a point located on the water surface of pool water envelopes.

6.6.2 Point A is a construction location nearest the deep end wall where the minimum water depth D_1 is satisfied.

6.6.3 Point A, as shown in figure 1 and table 2, shall be the referenced point of origin for all dimensions defining a minimum water envelope.

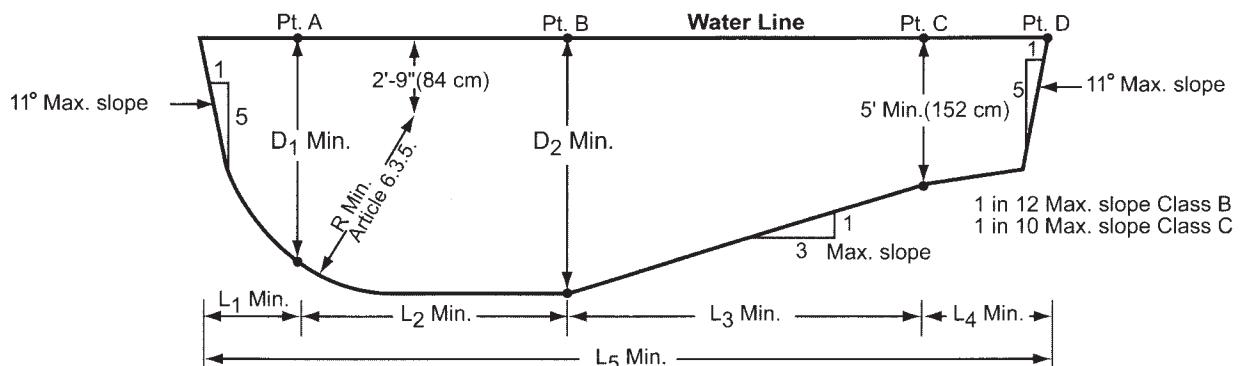

Figure 1 - Construction dimensions for water envelopes for Class B and Class C pools

SUPPORT INFORMATION: ARTICLES 1-7

Extracted from ANSI/NSPI-1 2003, American National Standard for Public Swimming Pools

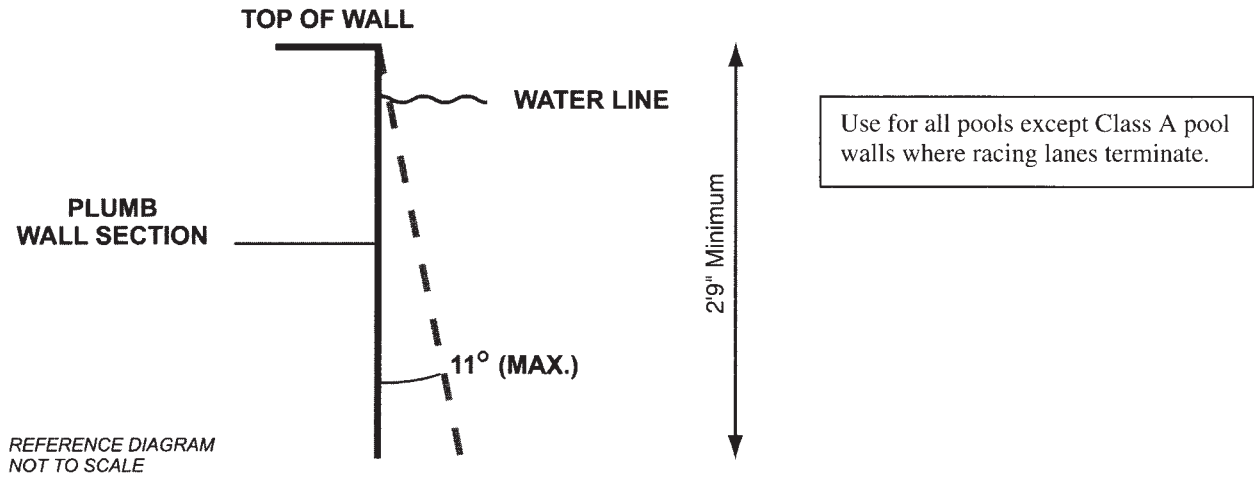

Figure 2 – Maximum allowable wall slope

Table 2 – Minimum water envelopes

Pool type	Minimum dimensions								Minimum width of pool at:		
	D ₁	D ₂	R	L ₁	L ₂	L ₃	L ₄	L ₅	Pt. A	Pt. B	Pt. C
VI	7'-0" (213 cm)	8'-6" (259 cm)	5'-6" (168 cm)	2'-6" (76 cm)	8'-0" (244 cm)	10'-6" (320 cm)	7'-0" (213 cm)	28'-0" (853 cm)	16'-0" (488 cm)	18'-0" (549 cm)	18'-0" (549 cm)
VII	7'-6" (229 cm)	9'-0" (274 cm)	6'-0" (183 cm)	3'-0" (91 cm)	9'-0" (274 cm)	12'-0" (366 cm)	4'-0" (122 cm)	28'-0" (853 cm)	18'-0" (549 cm)	20'-0" (610 cm)	20'-0" (610 cm)
VIII	8'-6" (259 cm)	10'-0" (305 cm)	7'-0" (213 cm)	4'-0" (122 cm)	10'-0" (305 cm)	15'-0" (457 cm)	2'-0" (61 cm)	31'-0" (945 cm)	20'-0" (610 cm)	22'-0" (671 cm)	22'-0" (671 cm)
IX	11'-0" (335 cm)	12'-0" (366 cm)	8'-6" (259 cm)	6'-0" (183 cm)	10'-6" (320 cm)	21'-0" (640 cm)	0 (0 cm)	37'-6" (11.4 m)	22'-0" (671 cm)	24'-0" (732 cm)	24'-0" (732 cm)

NOTE – For definition of pool types see Glossary

SUPPORT INFORMATION: ARTICLES 1-7

Extracted from ANSI/NSPI-1 2003, American National Standard for Public Swimming Pools

Table 3 – Maximum user load

Pool/Deck area	Shallow instructional or wading areas	Deep area (not including the diving area)	Diving area (per each diving board)
Pools with minimum deck area (See 7.1.6 through 7.1.6.1.)	15 sq. ft. per user (1.35 m ² per user)	20 sq. ft. per user (1.8 m ² per user)	300 sq. ft. (27 m ²)
Pools with deck area at least equal to water surface area	12 sq. ft. per user (1.08 m ² per user)	15 sq. ft. per user (1.35 m ² per user)	300 sq. ft. (27 m ²)
Pools with deck area at least twice the water surface area	8 sq. ft. per user (0.72 m ² per user)	10 sq. ft. per user (0.9 m ² per user)	300 sq. ft. (27 m ²)

6.7 Rest ledges. Rest ledges along the pool walls are permitted. They must be not less than 4 feet (122 cm) below the water surface. If a ledge is provided it shall be at least 4 inches (10 cm) wide and no more than 8 inches (20 cm) wide.

6.8 Maximum user load. The maximum user load of Class B or Class C pools shall be in accordance with table 3.

6.9 Wading pools. A wading pool shall be a separate pool with an independent circulation system and physically separated from the main pool as described in 6.9.1 through 6.9.4.

6.9.1 Areas where the water depth at the edge of the pool exceeds 9 inches (23 cm) shall be considered non-entry areas and must be protected by natural or artificial barriers.

6.9.2 Floors of wading pools shall be uniform and sloped to drain with a maximum slope of 1 foot in 12 feet (30 cm in 360 cm).

6.9.3 The maximum water depth shall be 18 inches (46 cm).

6.9.4 The maximum distance from the top of the deck to the water line shall not exceed 6 inches (15 cm).

7 Decks and deck equipment

7.1 Decks shall comply with 7.1.1 through 7.1.17 as applicable.

7.1.1 Deck(s) shall be designed and installed in accordance with the engineering methods required by the authority having jurisdiction.

7.1.1.1 In the absence of specific local requirements, a concrete deck shall be designed and constructed in accordance with the recommended practices of the most recent edition of American Concrete Institute (ACI) Standard 302.1R-96, *Guide for concrete floor and slab construction*, or in accordance with the requirements of the local authority, the authority having jurisdiction, or both. The deck shall be designed and constructed to meet the applicable requirements of the Americans with Disabilities Act.

7.1.2 Decks, ramps, coping, and similar step surfaces shall be slip resisting and cleanable.

7.1.3 Special features in or on deck(s) such as markers, brand insignias, or similar materials shall be slip resisting.

7.1.4 Step risers for the deck shall be uniform and have a minimum height of 3-3/4 inches (9.5 cm) and a maximum height of 7-1/2 inches (19 cm). A handrail shall be provided for stairs having three or more risers. The minimum tread distance from front to back shall be 11 inches (28 cm).

7.1.5 The deck or unobstructed access shall be provided at a minimum of 65% of the pool perimeter to meet the requirement of the 10/20 rule. (See appendix H, Glossary.)

7.1.5.1 A minimum 4 feet (122 cm) deck width shall be provided on the sides and rear of any diving equipment. A deck clearance of 3 feet (91 cm) shall be provided around all other deck equipment.

7.1.6 The minimum slope of the deck(s) shall be 1/8 inch per 1 foot (3.2 mm per 304.8 mm) for textured, hand-finished concrete decks; 1/4 inch per 1 foot (6.4 mm per 304.8 mm) for exposed aggregate

SUPPORT INFORMATION: ARTICLES 1-7

Extracted from ANSI/NSPI-1 2003, American National Standard for Public Swimming Pools

concrete decks; 1/2 inch per 1 foot (12.7 mm per 304.8 mm) for indoor/outdoor carpeting decks; and 3/8 inch per 1 foot (9.5 mm per 304.8 mm) for brick and heavy textures finishes, unless an alternate drainage method is provided that prevents the accumulation of pooling of water. (See table 4.)

7.1.6.1 Decks shall be sloped so that standing water shall be no deeper than 1/8 inch (3.2 mm), 20 minutes after the cessation of the addition of water to the deck.

NOTE – Two stacked U.S. quarters can be used to measure the depth. Water should not cover the quarters.

7.1.7 The maximum slope of all decks, other than wood decks, shall be 1/2 inch per foot (12.7 mm per 304.8 mm) except for ramps.

7.1.7.1 The maximum slope for wood decks shall be 1/8 inch per 1 foot (3.2 mm per 304.8 mm).

7.1.7.2 Gaps shall be required between deck boards in wood decks and shall be consistent with approved engineering methods with respect to the type of wood used and shall not cause a tripping hazard.

7.1.8 The maximum open gap between pool decks and adjoining decks or walkways, including joint material, shall be 3/4 inch (19.1 mm). The difference in vertical elevation between the pool deck and the adjoining sidewalk shall be 1/4 inch (6.4 mm) unless it conforms to 7.1.4.

7.1.9 Construction joints where the pool coping meets the concrete deck(s) shall be watertight.

7.1.10 Construction joints where the pool coping meets the concrete deck(s) shall be installed to protect the coping and its mortar bed from damage as a result of the anticipated movement of adjoining deck(s).

7.1.11 Control joints in deck(s) shall be provided to minimize visible cracks outside the control joints due to imposed stresses and/or movement of the slab.

7.1.12 Areas where decks join existing concrete work shall be protected by an expansion joint to protect the pool from the pressures of relative movements.

7.1.13 The edges of all decks shall be radiused, tapered, or otherwise designed to eliminate sharp corners.

7.1.14 Pressure tests. A pressure test shall be maintained throughout the deck pour and in accordance with 8.4.

7.1.15 Valves installed in or under any deck(s) shall have access provided for operation, service, and maintenance. Access covers shall be provided.

7.1.16 Hose bib(s), with a cross connection control to prevent backflow, shall be provided for rinsing down the entire deck and shall be in accordance with the authority having jurisdiction.

7.1.17 Water-powered devices (such as water-powered lifts) shall have a dedicated hose bib (water source).

7.2 Deck equipment. Deck equipment including diving facilities and starting blocks shall comply with 7.2.1 through 7.4 as applicable.

Table 4 – Typical minimum drainage slope

Surface	Typical minimum drainage slope (inch per foot)
Textured, hand-finished concrete	1/8 in. (3.2 mm)
Exposed aggregate	1/4 in. (6.4 mm)
Carpet	1/2 in. (12.7 mm)
Brick and heavy textures finished	3/8 in. (9.5 mm)

SUPPORT INFORMATION: ARTICLES 1-7

Extracted from ANSI/NSPI-1 2003, American National Standard for Public Swimming Pools

7.2.1 A minimum 4 feet (122 cm) deck width shall be provided on the sides and rear of any diving equipment.

7.2.2 Starting blocks. Starting blocks are intended for competitive swimming and shall conform to Federation Internationale de Natation (FINA), U.S.A. Swimming, National Collegiate Athletic Association (NCAA), or National Federation of State High Schools Associations (NFSHSA).

7.2.3 There shall be a completely unobstructed distance of 14 feet (427 cm) above the tip of the diving board or as specified by the diving equipment manufacturer or the authority having jurisdiction.

7.2.4 Public pools with diving equipment of 1 meter (39 inches) or greater in height, or pools designed for springboard or platform diving, shall comply with the dimensional design requirements of Federation Internationale de Natation (FINA), U.S. Diving, National Federation of State High Schools Association (NFSHSA) or the appropriate sanctioning body.

7.2.5 Diving equipment. Diving equipment shall be installed in accordance with the manufacturer's specifications.

7.2.5.1 The diving equipment manufacturer shall affix a label to the diving equipment.

7.2.5.2 A label shall be permanently affixed to the diving equipment or jump board and shall include but not be limited to the following:

- The minimum water envelope required for each diving board and diving stand combination,
- Manufacturer's name and address,
- Manufacturer's identification and date of manufacture, and
- The maximum weight of the user, visibly located on the diving board.

7.2.5.3 The diving equipment manufacturer shall provide diving equipment use instructions.

7.2.5.4 Diving equipment shall have slip-resisting tread surfaces.

7.2.5.5 Supports for diving equipment. Supports, platforms, stairs, and ladders for diving equipment shall be designed to carry the anticipated loads. Stairs and ladders shall be of corrosion-resisting material and shall be easily cleanable and with slip-resisting tread. All diving stands higher than 21 inches (53 cm) measured from the deck to the top butt end of the board shall be provided with stairs and/or a ladder. Step treads shall be self-draining.

7.2.5.6 Diving equipment 1 meter high (39 inches) or greater shall be provided with a top guard rail, which shall be at least 30 inches (76 cm) above the diving board and extend to the edge of the pool wall and to the deck surface.

7.3 Swimming pool slides. Swimming pool slides, when installed, shall comply with the requirements of the U.S. Consumer Product Safety Commission (CPSC) as published in the *Code of Federal Regulations*, 16 CFR, Part 1207. The manufacturer shall provide installation and use instructions with each slide. Each slide shall be installed in accordance with the manufacturer's instructions.

7.4 Play/water activity equipment. When installed, play/water activity equipment shall be installed in accordance with manufacturer's instructions.

SUPPORT INFORMATION: ARTICLE 23.1.5

Extracted from ANSI/NSPI-1 2003, American National Standard for Public Swimming Pools

23.1.5 If the pool is designed for use with diving equipment, the entries and exits, pool stairs, ladders, underwater benches, special features, and other accessories shall be located outside the minimum diving water envelope as shown in figure 3.

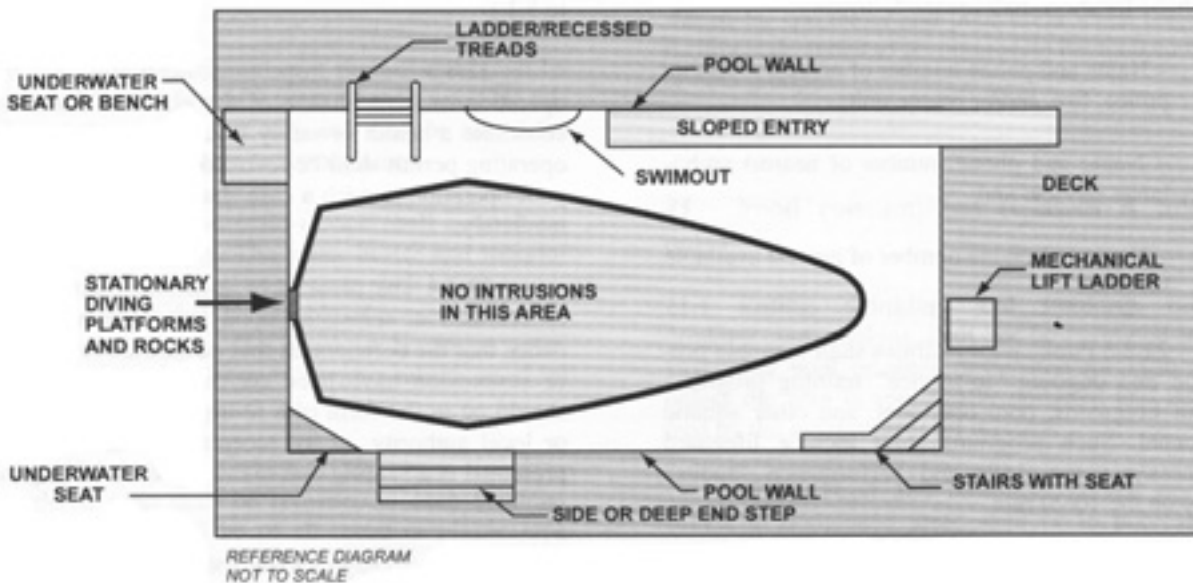

Figure 3 – Minimum diving water envelope

To obtain complete copies of the ANSI/NSPI-1 2003 Standard for Public Swimming Pools contact:

**The Association of Pool & Spa Professionals (APSP)
 2111 Eisenhower Ave.
 Alexandria, VA 22314
 (703) 838-0083**

or visit: www.apsp.org

LIMITED WARRANTY

Inter-Fab, Inc. will repair or replace, at its option, any product manufactured by Inter-Fab, Inc. that fails during the applicable warranty period because of a manufacturing or material defect; provided that the defect is not the result of improper installation, improper use or care, negligence, alterations or modifications to the product, or natural accidents (acts of God). The applicable warranty period for products manufactured by Inter-Fab, Inc. is three (3) years from the date of retail purchase, except as specified below:

Echoes of Nature™ products are individually handcrafted and painted by skilled artisans and as a result, dimensional differences and color variations are normal and are not a basis for warranty coverage. The warranty period for pumps sold with the Echoes of Nature™ products is three (3) years from the date of retail purchase.

Water Sports™ sports equipment warranty periods are as follows: Volleyball Poles, Basketball Poles, Basketball Rim, and Basketball Backboard are one (1) year from date of retail purchase. Volleyball, Volleyball Net, Basketball, Basketball Net, and pumps are warranted for ninety (90) days from date of retail purchase.

Splash Rock™ Edgewater, **T7™** Edgewater™ and **Lighted Edgewater™** features warranty period is one (1) year from date of retail purchase.

Zoomerang™ slide products warranty period is one (1) year from the date of retail purchase.

Build Your Own Slide™ (BYOS™) warranty period is one (1) year from the date of retail purchase.

City 2™ Slide and **City Base™** products warranty period are one (1) year from the date of retail purchase.

Unless expressly stated otherwise all products manufactured by Inter-Fab are for **residential installation (single family residence)** inground pool use only. Inter-Fab, Inc. expressly disclaims any and all warranties and liability arising from the installation or use of its residential products for any non-residential use such as semi-public, public, or commercial applications. Products expressly manufactured for commercial installation and use will be subject to this limited warranty.

This limited warranty is in lieu of all other warranties, whether express or implied. Inter-Fab, Inc. disclaims any warranty of merchantability or fitness for a particular use, and noninfringement in relation to any of its products and Inter-Fab, Inc. is not liable for consequential, incidental or specific damages. This warranty is limited to the repair or replacement of the manufacturing or material defect, or refund of the original purchase price, whichever is less, at the sole option of Inter-Fab, Inc., and expressly does not cover any labor or reinstallation expenses related to the replacement of any and all Inter-Fab products. This limited warranty shall be the sole and exclusive remedy of irrespective of whether the claims are made in contract, tort, warranty, law, equity or by statute.

This warranty is to the original purchaser of the product only. Inter-Fab's limited warranty is neither transferable nor portable from consumer to consumer. The effective coverage date begins at the date of retail purchase. Product owner or representative must notify Inter-Fab, Inc. (or its wholesale agent) in writing, giving a full description of the nature of the product defect or failure along with proof of purchase, serial number(s) of the product and photos within thirty (30) days of the expiration of the applicable warranty period. Inter-Fab, Inc. reserves the right to physically inspect damaged or defective products or components to determine the cause of the damage or defect, prior to authorizing repair or replacement of its products.



3050 S. Alvernon Way • Tucson, AZ 85713

520.790.7040 • 800.737.5386 • Fax 520.790.7127 • inter-fab.com