

**E/ES-Series
Ultraviolet Sanitizer/Clarifier System**



**INSTALLATION AND MAINTENANCE
MANUAL**

**DELTA ULTRAVIOLET CORPORATION
CORPORATE HEADQUARTERS**

1535 West Rosecrans Ave
Gardena, CA 90249
Phone 310-323-6400 – Toll free 866-UV9-8765
Fax 310-323-6403



Thank you for choosing a Ultraviolet Sanitizer from the Delta UV E-ES series. Our equipment has been designed to provide long term, reliable service.

The sanitizer in the E-ES series has been designed to enable fast, easy installation. Its design also enables easy maintenance.

Please read these instructions carefully in order to ensure optimal operating conditions for your bactericide unit.



The Delta UV Unit is designed for use in swimming pools, fountains, water features, waterfalls and fish ponds. It is not designed for use in potable (drinking) water installations. Use of this product in applications other than those indicated above will void your warranty and could be harmful to your health or the health of others.

CONTENTS :

Page

A. TECHNICAL CHARACTERISTICS.....	
B. WARNINGS AND SAFETY	
C. SANITIZER INSTALLATION	
D. ELECTRICAL CHAMBER	
E. START-UP.....	
F. UV LAMP REPLACEMENT & QUARTZ TUBE MAINTENANCE.....	
G. FAQ	
H. TROUBLESHOOTING	
DELTA UV LIMITED WARRANTY	

A. TECHNICAL CHARACTERISTICS

E Series					
	E-5	E-10	E-15	E-20	E-40
SANITIZER					
Material	PVC	PVC	PVC	PVC	PVC
Maximum pressure in Use	40psi	40psi	40psi	40psi	40psi
Flow	31gpm	50gpm	57 gpm	80gpm	110gpm
Diameter	9 in.	9 in.	9 in.	9 in.	9 in.
Height	18 in.	25 in.	28 in.	39 in.	46in.
Inlet / Outlet	2 in.	2 in.	2 in.	2 in.	2 in.
Power supply	120 V/240V 50-60Hz	120 V/240V 50-60Hz	120V/240V 50-60Hz	120 V/240V 50-60Hz	120 V/240V 50-60Hz
Protection index	IP 54 NEMA 3	IP 54 NEMA 3	IP 54 NEMA 3	IP 54 NEMA 3	IP 54 NEMA 3
UV LAMP					
Number of lamp	1	1	1	1	1
Power	35W	45W	55W	90W	110W
Performance at the recommended flows	30 mJ/cm ²	30 mJ/cm ²	30 mJ/cm ²	30 mJ/cm ²	30 mJ/cm ²

ES Series					
	ES-5	ES-10	E-15	ES-20	ES-40
SANITIZER					
Material	Stainless Steel / PVC				
Maximum pressure in Use	40psi	40psi	40psi	40psi	40psi
Flow	31gpm	50gpm	57 gpm	80gpm	110gpm
Diameter	9 in.	9 in.	9 in.	9 in.	9 in.
Height	18 in.	25 in.	28 in.	39 in.	46 in.
Inlet / Outlet	2 in.	2 in.	2 in.	2 in.	2 in.
Power supply	120 V/240V 50-60Hz	120 V/240V 50-60Hz	120V/240V 50-60Hz	120 V/240V 50-60Hz	120 V/240V 50-60Hz
Protection index	IP 54 NEMA 3	IP 54 NEMA 3	IP 54 NEMA 3	IP 54 NEMA 3	IP 54 NEMA 3
UV LAMP					
Number of lamp	1	1	1	1	1
Power	35W	45W	55W	90W	110W
Performance at the recommended flows	30 mJ/cm ²	30 mJ/cm ²	30 mJ/cm ²	30 mJ/cm ²	30 mJ/cm ²

B. WARNINGS AND SAFETY

IMPORTANT SAFETY INSTRUCTIONS

SAVE THESE INSTRUCTIONS
READ AND FOLLOW ALL INSTRUCTIONS

WARNING

FOR YOUR SAFETY – This product should be installed by a professional service technician or similar person, qualified in electrical equipment installation. Improper installation and/or operation could cause serious injury, property damage or death. Improper installation and/or operation will void the limited warranty.

INSTRUCTIONS PERTAINING TO RISK OF FIRE, ELECTRIC SHOCK OR INJURY TO PERSON

WARNING — To guard against injury when using this unit, basic safety precautions should always be taken, including the following:

1. **READ AND FOLLOW ALL SAFETY INSTRUCTIONS.**
2. **DANGER:** To avoid possible electrical shock, special care should be taken since water is employed in the use of this equipment. For each of the following situations, do not attempt repairs yourself; return the appliance to an authorized service facility for service or discard the appliance.
 - A. If the appliance falls into the water, **DO NOT** reach for it ! First unplug it and then retrieve it. If electrical components of the appliance get wet, unplug the appliance immediately.
 - B. Do not operate any appliance if it has a damaged cord or plug, or if it is malfunctioning or if it is dropped or damaged in any manner.
3. Do not use an appliance for anything other than its intended use. The use of attachments not recommended or sold by the appliance manufacturer may cause an unsafe condition.
4. Always unplug an appliance from an outlet when not it use, before putting on or taking off parts, and before cleaning. Never yank the cord to pull the plug from the outlet. Grasp the plug and pull it to disconnect it.
5. Never drop or insert any object into any opening.
6. This unit contains an ultraviolet bulb that can cause discomfort or irritation to the eyes if viewing while operating. Prolonged exposure to the eyes can cause blindness. **DO NOT VIEW UV BULB WHILE OPERATING OR DURING MAINTENANCE.**
7. Read and observe all of the important notices on the appliance.
8. **Warning**–To reduce the risk of electrocution, keep all connections dry and off the ground. Do not touch the plug with wet hands.
9. If an extension cord is necessary, a cord with a proper rating should be used. A cord rated for less amperes or watts than the appliances rating may overheat. Care should be taken to arrange the cord so that it will not be tripped over or pulled.
10. This product shall only be connected to a power supply receptacle protected by a Ground Fault Circuit Interrupter (GFCI). If this unit is not equipped (optional) with a GFCI, a GFCI should be provided by the installer and should be tested on a routine basis. To test the GFCI, push the test button. The GFCI should interrupt power. Push the reset button. Power should be restored. If the GFCI fails to operate in this manner, the GFCI is defective. If the GFCI interrupts power to the unit without the test button being pushed, a ground current is flowing, indicating the possibility of an electric shock. Do not use this unit. Disconnect the unit and have the problem corrected by a qualified service representative before using.
11. Always check Local Ordinance and Building Codes for your city before installation of equipment.

12. Protect the unit from direct prolonged sunlight exposure.

WARNING

When using electrical products, basic precautions should always be followed, including the following:

1. **DANGER: RISK OF ELECTRIC SHOCK.** Connect only to a circuit protected by a Ground Fault Circuit Interrupter.
2. **Grounding is required.** The unit should be installed and grounded by a qualified service representative.
3. **Install to permit access for servicing.** Make sure you choose a position where the lamp can be taken out – the **AVAILABLE HEIGHT** should be **DOUBLE** the total height of the unit.

IMPORTANT: Follow the instructions **EXACTLY** and **IN THE ORDER LISTED**. Once installed, your UV unit will provide years of successful operation.

IMPORTANT SAFETY INSTRUCTIONS

*****PRIOR TO BEGINNING INSTALLATION INSTRUCTIONS*****

Visually inspect the unit for a broken or cracked quartz tube

Contact the dealer/manufacturer for replacement if quartz tube is broken

Extension Cords

Use only 3-wire extension cords that have 3-prong grounding-type plugs and 3-pole cord connectors that accept the plug from the product. Use only extension cords that are intended for outdoor use. These extension cords are identified by a marking “Acceptable for use with outdoor appliances; store indoor when not in use.” Use only extension cords having an electrical rating not less than the rating of the product. Do not use damaged extension cords. Examine extension cords and do not yank on the cord to disconnect it from the receptacle. Keep the cord away from heat and sharp edges. Always disconnect the receptacle before disconnecting the product from the extension cord.

Warning – To reduce the risk of electrocution, keep all connections dry and off the ground.
Do not touch the plug with wet hands

INTRODUCTION

Forward: The Delta UV Unit is designed for use in swimming pools, fountains, water features, waterfalls and fish ponds. It is not designed for use in potable (drinking) water installations. Use of this product in applications other than those indicated above will void your warranty and could be harmful to your health or the health of others.

Introduction - How The Delta UV Unit Works: Within the Delta UV Unit (which we will refer to throughout this manual as DELTA UV), a high intensity electrically operated Ultraviolet (UV) bulb is located inside the unit's wet chamber. This UV bulb gives off Ultraviolet light wave emissions when lit. The bulb's operating emission range is within the Ultraviolet light wave spectrum at 253.7 nm of wavelength. This wavelength is such that when bacteria, protozoa, viruses, algae spores, or other single celled waterborne microorganisms in the incoming water flow are exposed to the light waves of the UV bulb for a proper period of time, the DNA of the microorganism is altered or disrupted and this controls and eradicates these unwanted contaminants and renders them harmless. Your DELTA UV unit has been sized to produce these important UV rays in the same intensity as is required for Class A potable drinking water, which is 30 microwatts/sec/cm².

While you may see lesser competitive units of similar vessel size claiming to work on larger ponds or pools, you will find that these units do not operate at the same high intensity as does the DELTA UV unit and are unable to obtain the same level of killing power as the DELTA UV unit. Rely on the flow chart shown herein for proper maximum killing power unit selection for your application. See Sect. A

Pond or pool water containing these unwanted contaminants enters the DELTA UV unit's wet chamber and is exposed to the light rays generated by the UV bulb. The DELTA UV unit has been designed to allow for some turbidity in the water, as turbidity will reduce the UV light wave transmission capability. Therefore, all DELTA UV units are sized to allow for possible turbidity in the water and the reduction in the killing power of the UV bulb when it nears the end of its useful life. When the incoming water is exposed to the bulb for the proper duration and intensity, the water exiting the unit is near drinking water biological quality. ***CAUTION!:*** ***THIS UNIT IS FOR POND OR POOL USE ONLY. DO NOT USE THIS UNIT FOR POTABLE (DRINKING) WATER SANITIZATION.***

PRE-INSTALLATION

Pre-Installation - In order to ensure that your DELTA UV unit functions with the proper exposure time to achieve the desired water sanitization, it is important to provide the proper water flow rate through the DELTA UV unit. If water passes through the unit too quickly, the exposure time of the microorganisms to the UV bulb produced rays will not be sufficient to obtain the desired kill rate. The water flow rate through the UV unit is governed by the piping of your pool or pond and the size and output of your circulation pump. There also needs to be



consideration to the application for the UV unit. Fish ponds have different requirements than do swimming pools, water features, fountains, or waterfalls.

Swimming Pool Turnover Rates - Swimming pools are somewhat simpler to calculate for flow rates. Most residential pools are designed to have the capacity of the pool turned over every 12 hours. Semi-commercial pools are normally designed for an 8 hour turnover flow rate. Check with your local jurisdiction for the required flow rate for your type of pool to be sure. Thus, as an example, using the same formula as above, a 20,000 gallon residential pool will need to have a pump capable of a 28 GPM flow rate and a 25,000 gallon Semi-commercial pool will need to have a pump capable of 52 GPM.

Like pools and ponds, the DELTA UV unit needs to be properly sized by flow rate. Moving the water through the DELTA UV unit’s wet chamber too fast will not allow enough exposure time of the water to be exposed to the UV bulb rays for the required exposure time. The following chart shows the desired and maximum flow rates for your DELTA UV unit. Make sure the flow rate of your circulation system pump does not exceed the maximum allowable flow rate of the UV unit you have selected. (Consult your supplier or pump manufacturer for the pump’s GPM rating if you are in doubt). If the pump output exceeds the maximum flow rate of the DELTA UV unit you have selected, select an DELTA UV model with a higher flow rate capacity rating or consider a multiple unit installation.

C. Sanitizer Installation

INSTALLATION



	<ul style="list-style-type: none"> ● CAUTION: We recommend the presence of a by-pass.
	<ul style="list-style-type: none"> ● Before accessing the connection terminals, ensure that all supply circuits are disconnected. ● The Sanitizer installation as a whole must be protected with a suitably adapted circuit breaker. (See A. Technical characteristics) ● Check Local ordinances and building codes before installation of equipment. (See A. Technical characteristics)



Installation — Before starting the installation, **PLEASE** read this manual from cover to cover. A few moments spent initially becoming totally familiar with the DELTA UV unit and its installation requirements will save a great deal of time (and expense) later. If you have questions that are not answered after you have completed the reading of this manual, contact your supplier or Delta UV. We are ready to assist you at anytime and we want your installation to go smoothly and the equipment to work properly.

Locating The UV Unit - Once you have confirmed the sizing of your pond or pool and compared that information against the requirements of your DELTA UV unit by using the charts above, it is now time to install your unit. The DELTA UV unit comes with all internal components fully assembled and ready for installation. Only the Inlet/Outlet unions and pressure gauge need to be installed to ready your unit for installation. All parts of the DELTA UV units are UV inhibited PVC plastic. Thus, your unit will function fine in the outdoors. Installing the DELTA UV unit indoors or inside a covered area is preferred however, to keep your unit looking new. The DELTA UV unit will need to be powered from an electrical outlet. If the electrical outlet is outdoors and open to the weather, it will need to be an Outdoor type receptacle. The DELTA UV unit comes with a twelve foot power cord (E/ES-5, E/ES-10 six foot cord). Do not use an extension cord unless it is at least a 16/3 size conductor waterproof type and is no more than twenty-five feet (7.5 meters) long.

Plumbing The UV Unit - Your DELTA UV unit will need to be plumbed into your pond or swimming pool circulation system. The diagram (Fig. 1) shows how the unit is to be plumbed. Note that the water is to be piped from the pressure side of the pump and after the filter, in and out of the DELTA UV unit. The inlet for the water is at the bottom of the DELTA UV unit, and the outlet is at the top of the DELTA UV unit. If your pump exceeds the maximum flow rate of the DELTA UV unit, installation of a plumbing by-pass will be necessary to bypass some of the pump's flow around the DELTA UV unit so the maximum flow rate of the DELTA UV unit will not be exceeded. **Bypass system is recommended in all installations.**

USE and MAINTENANCE:

	<ul style="list-style-type: none"> ● Allow the ultraviolet lamp to cool for at least 30 minutes before handling.
	<ul style="list-style-type: none"> ● Never look at the ultraviolet lamps when lit. This may cause severe injuries or burns and may even lead to loss of eyesight.
	<ul style="list-style-type: none"> ● Do not touch the ultraviolet lamp with bare hands, as these would leave impurities that shorten the life of the lamp. If you do touch it:

	clean with alcohol or white vinegar.
	<ul style="list-style-type: none"> • Never unscrew the quartz tube sealing nut when the sanitizer is on load as the quartz tube could be blown out of the sanitizer with force and injure you.
	<ul style="list-style-type: none"> • To avoid electric short-circuits; do not place the electric wires or the sanitizer in the pool water or in any other maintenance or cleaning fluid. • Do not restart the system until the electric unit, the covers exterior elements of the sanitizer are correctly put back in place. • When replacing the lamp or carrying out annual cleaning of the quartz tube, make sure that the electrical elements are in place and correctly attached before switching on the sanitizer.
	<ul style="list-style-type: none"> • Do not use the Delta UV sanitizer for any other use than that for which it was designed. • Hg-Lamp CONTAINS MERCURY. Manage in accord with disposal laws. www.lamprecycle.org

The Delta UV unit comes with all internal components fully assembled and **ready for installation**. Only the Inlet/Outlet unions and pressure gauge need to be installed to ready your unit for installation.

Inlet / Outlet UNIONS

Your Delta UV unit will need to be plumbed into your pond or swimming pool circulation system.



We recommend the presence of a by-pass.

The inlet for the water is at the bottom of the Delta UV unit.

The SOLID COLOR union tail piece is used on the BOTTOM union.

The outlet for the water is at the top.

The CLEAR union tail piece is used on the TOP union.

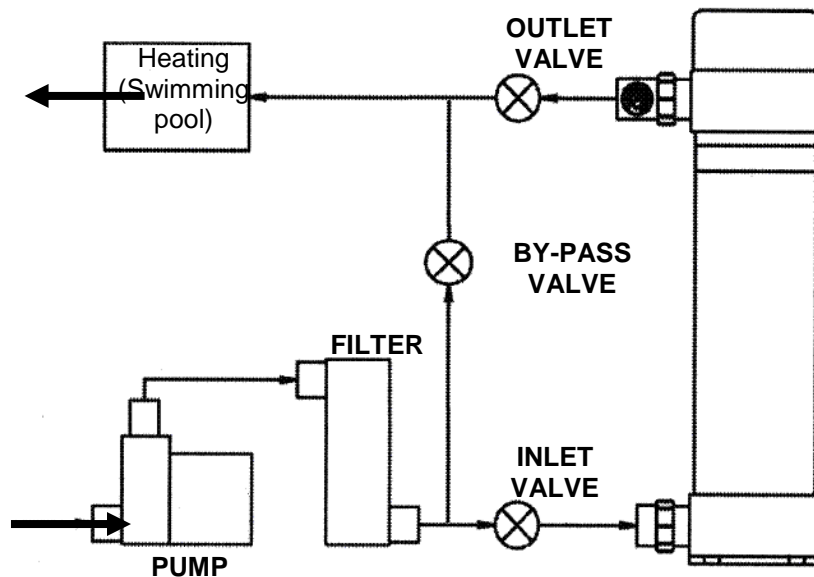

FIG. 1

Installing Inlet/Outlet Unions - The DELTA UV unit comes with union nuts installed on the housing. Packed with your DELTA UV unit are the remaining components necessary to complete the Inlet/Outlet unions. The clear union tail piece is used on the top union, and the solid color union tail piece is used on the bottom union. Also packed with your DELTA UV unit are two white gaskets that are used to complete the Inlet/Outlet unions. One side of the gasket is flat, the other side has a half round bead on the face. The two unions each have a groove in the face of the union tail piece and that groove accepts the half round bead of the gasket to hold the gasket in place correctly. Place the gaskets into the face of the union tail pieces. Now, install the union tail pieces by screwing them into the union nuts on the DELTA UV unit. **DO NOT OVERTIGHTEN.** Hand tightening is sufficient. **OVERTIGHTENING WILL BREAK THE UNION NUTS.** Replacement split nut available from Delta UV only (Part # 86-02334, (2 of) 40-06006).

Mounting The UV Unit On A Solid Base - The next step is to secure the DELTA UV unit to a concrete or wood base. Four mounting holes are located in the mounting base of the DELTA UV unit. These holes accommodate ¼ inch diameter bolts to mount the DELTA UV unit in place. **FAILURE TO PROPERLY SECURE THE UNIT MAY CAUSE NOISE DUE TO VIBRATION CAUSED BY WATER PASSING THROUGH THE WET CHAMBER.** Secure the DELTA UV unit using bolts and anchors (not supplied) where necessary and appropriate for your installation. When the DELTA UV unit is secured in position, the piping of the unit can begin.

Gluing Piping To The UV Unit - The Inlet/Outlet PVC union tail pieces are 2 inch pipe size (63mm for overseas models). Your PVC supply piping should be glued into the union tail pieces using an appropriate PVC primer and PVC cement, as recommended by your supplier. Inlet piping should be supported and should not rest solely upon the unions, to avoid breaking the unions. The installation of valves on the inlet and outlet lines attached to the UV unit is

recommended. If the DELTA UV unit is located with any portion of the unit below the surface of the pond or pool, then **VALVES ARE MANDATORY**, so you may winterize or remove the DELTA UV unit without draining your pool or pond. When you have completed the piping installation (including bypass if necessary), the final step is to plug in the unit to its power source. **It is very important to mount the ballast a minimum of 16 in. above the ground.**

INSTALLING PRESSURE GAUGE

Your DELTA UV unit also comes with a pressure gauge that is used to confirm that your pump is not exceeding the 40 PSI maximum working pressure for the DELTA UV unit. To install the pressure gauge, screw it into the threaded tap on the clear union tail piece that you have installed on the DELTA UV unit. If the DELTA UV unit is installed indoors, the pressure gauge can be installed so it is facing upward. However, if the DELTA UV unit is installed outdoors, the pressure gauge must be installed on one side or the other of the clear tailpiece so that it will be in a vertical position when installed. Installing the gauge facing upwardly when the DELTA UV unit is outdoors will result in the gauge filling full of rainwater and will ruin the gauge. The gauge location and orientation that you choose is dependent upon which side of the fitting provides the best viewing of the gauge dial. **Caution:** Do not cross-thread the gauge when installing it into the plastic union, as it will ruin the plastic threads and will leak.

Be sure to hand tighten the pressure gauge into the clear tail piece, using the square brass boss on the back of the pressure gauge. **DO NOT OVERTIGHTEN.** Over tightening will cause the clear plastic union tail piece to crack. Three or four threads are all that is necessary to seal the pressure gauge. If the gauge leaks upon start-up, simply tighten one more rotation. **DO NOT TIGHTEN BY GRASPING THE COVER OF THE PRESSURE GAUGE.**

ELECTRICAL BONDING



THE EQUIPMENT MUST BE CONNECT TO A GFCI PROTECTED CIRCUIT

Electrical Connection - The electrical power rating for your DELTA UV unit is shown on the label on the outside of the unit. US and Canadian DELTA UV units operate on 120/240V 50/60 Hz – (1.15 Amps maximum). This low power consumption makes operating your DELTA UV unit very economical. Therefore, you will need a 15Amp 120V receptacle for your DELTA UV unit to plug into. (Check the label on your overseas unit for its power requirement). Your DELTA UV unit is supplied with a twelve foot (six foot E/ES-5, E/ES-10) long weatherproof power cord terminating in either a 3-prong grounded NEMA plug. The plug assembly contains the electrical ballast that operates the UV bulb in the E/ES unit. **Ballast should be mounted to**

secured object with 3-prong grounded NEMA plug end facing downward. In the US or Canada it is mandatory that you install a GFCI in the electrical outlet or in the breaker panel serving the E/ES unit power receptacle. If a Retrofit Cord Connected GFCI Kit (Part # 70-09012) you can order it from the supplier of your DELTA UV unit. This kit comes complete with everything you need to install the weatherproof GFCI on the end of the DELTA UV unit power cord. Easy to follow installation instructions are included with the kit and should take only a few minutes to complete. Verify that you have power to your electrical outlet and then plug the DELTA UV unit power cord into your power outlet.

Note: Should the electrical power cord of your DELTA UV unit become frayed or damaged in the future, unplug it from the power receptacle, and replace it immediately. Cut off NEMA plug and hardwire the 240V units.

Electrical Interlock Of Pump/UV Unit - The DELTA UV unit is equipped with a safety pressure switch that does not allow the UV bulb inside the unit to light unless there is at least .5 PSI operating pressure inside the chamber. This is to ensure that the bulb will not create heat when the DELTA UV unit is empty or water is not flowing in the wet chamber. Such excessive heat can shorten the life of the UV bulb. Therefore, only when the pump is pumping water through the DELTA UV unit wet chamber will you be able to see the UV bulb glow and confirm that it is on.

Note: Low pressure 1/2 psi pressure switches are available if you have a low pressure piping system (found most frequently in Koi pump installations). Order P/N 70-02305. Without the circulation pump operating, you will not see the bulb light up just by plugging the DELTA UV unit into its electrical outlet. Once the pump is pumping water through the DELTA UV unit, as confirmed by the indication of pressure on the pressure gauge, the bulb will light. To confirm that the bulb is indeed lit, you can view the glow of the bulb through the clear plastic union tail piece at the top outlet of the DELTA UV unit. This is the only location where you should attempt to view the UV bulb while it is on. The PVC union tail piece screens out the harmful UV rays and can be viewed with the naked eye without any damage to the eyes. If the bulb is not lit, check the troubleshooting section at the end of this manual.

Start-Up - Once you have completed all the preceding steps, (IMPORTANT) verify that the unit has no leaks anywhere, including a possible broken quartz tube damaged during transit, you are ready to start your unit up



The Delta UV unit should never be connected to any other power source other than its' own outlet.

D. ELECTRICAL CHAMBER

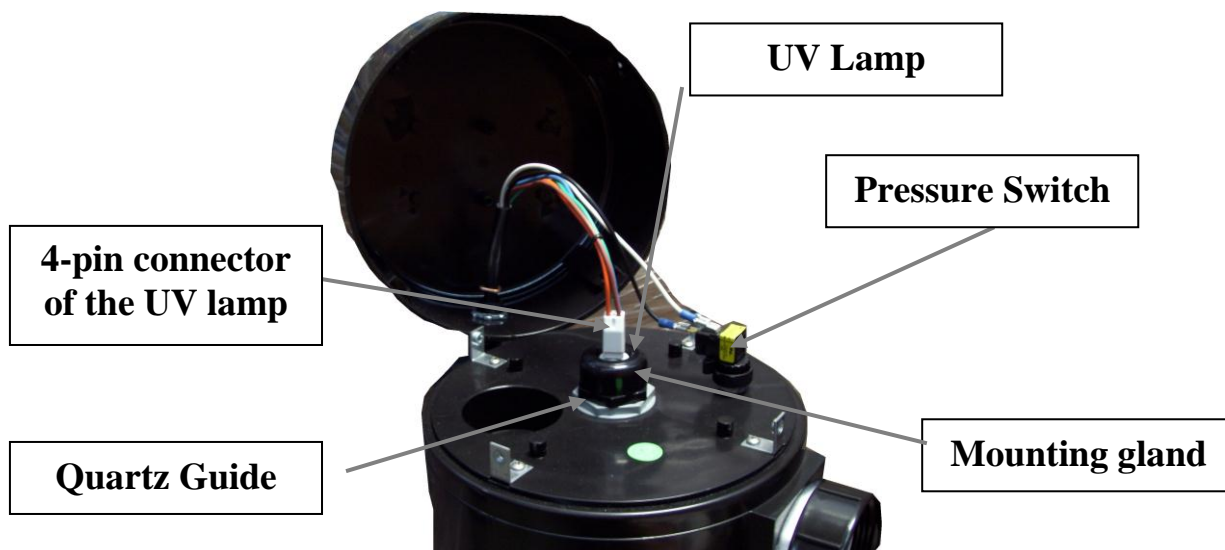

E. START-UP



Your Delta UV unit is equipped with a safety pressure switch.

This one does not allow the UV bulb inside the unit to light unless there is at least 0.3 Bar (.5 psi) operating pressure inside the chamber.

This is to ensure that the bulb will not create heat when the Delta UV unit is empty or water is not flowing in the wet chamber.

1	Start the circulation pump.
2	Drain all air from your system through the air relief valve on the filter (if so equipped).
3	Check DELTA UV Unit For Leaks - Make one final check for leaks in your piping, accessories, and under the electrical enclosure bonnet. If any water leakage under the DELTA UV unit's electrical enclosure bonnet is suspected (water dripping from under side of bonnet), disconnect the DELTA UV unit immediately, remove the bonnet (see 7.3) and verify that there is either (a) no leakage or (b) stop the leakage of the quartz tube gasket. If quartz tube leakage is encountered, follow the instructions in Sections 7.4 through 7.5 and 8.1 through 8.5 to remedy the situation before applying electrical power to your DELTA UV unit.
4	<p>Check the chemical balance of your swimming pool (particularly pH, TAC*, and TH*). Adjust the chemical balance as per your pool chemical suppliers' instructions. - Remember, the DELTA UV unit dramatically <u>reduces</u> the need for chemical sanitizers, but does not eliminate the need for proper pool chemical balance.</p> <div style="display: flex; align-items: center; margin-top: 10px;">  <p>Reminder: Your Delta UV does not eliminate the need for proper pool chemical balance.</p> </div>

* TAC = Acidimetric Titration (alkalinity of water)

* TH = Water Hardness

F. UV LAMP REPLACEMENT & QUARTZ TUBE MAINTENANCE

The DELTA UV unit requires very little maintenance during the year. The UV bulb in the DELTA UV unit is placed inside a quartz tube to protect the bulb from the water in the DELTA UV unit's wet chamber. This quartz tube can have its ability to transmit the UV rays from the bulb through the quartz tube diminished if the quartz tube becomes dirty or laden with deposits. The quartz tube should be removed from the wet chamber every six (6) months and inspected to make sure it is clean and that deposits are not attached to the quartz tube. To remove the quartz tube, you should follow the steps shown below.





Reminder: Do not touch the UV bulb glass with your bare hands.

That can shorten its life. Grasp the bulb on the white ceramic prong end or use a soft clean cotton cloth or clean cotton gloves to handle the UV bulb. (If you have touched the bulb with your bare hands, you must wipe the bulb glass off with spirit vinegar using a clean soft cotton cloth)



Disconnect Power: Unplug the DELTA UV unit from its power receptacle.

1	 <p>Stop Your Circulation Pump: You must shut off the circulation pump so that no water is flowing into the DELTA UV unit. Once the pump is shut off, verify on the pressure gauge that the pressure inside the DELTA UV unit is ZERO. If any pressure is indicated on the pressure gauge, do not go to the next step until the pressure gauge shows ZERO. If you show any pressure on the pressure gauge, but feel that there is no pressure present inside the DELTA UV unit, simply unscrew the top union nut on the DELTA UV unit. This will relieve any pressure. With the union partially unscrewed, the pressure gauge should show ZERO. If it does not, replace the pressure gauge (Part# 84-82234) immediately. When you are absolutely sure that there remains no pressure inside the DELTA UV wet chamber, you can proceed to the next step.</p>
2	Allow the ultraviolet lamp to cool for at least 30 minutes before handling.
3	Remove the plastic electrical enclosure bonnet by unscrewing the four mounting screws.
4	<p>Unplug the UV lamp by grasping the 4-pin connector (attached to the ballast wires).</p> <p>SLOWLY pull the UV lamp out of the quartz tube (by grasping the bulb on the white ceramic prong end).</p> <p>Check that bulb cushion and o-rings (between the lamp and the quartz tube) are still on bulb.</p>

	Carefully place the removed bulb in a safe location while cleaning the quartz tube.
5	Remove The Acorn Nut: Unscrew acorn nut by hand, if needed use a crescent wrench or 1-11/16" socket, remove the black plastic acorn nut (Part # 86-02411) holding the quartz tube into the black plastic mounting gland. Note that there is a rubber sealing gasket (Part # 44-02018) around the quartz tube (or inside the acorn nut) that seals the quartz tube to the mounting gland. Set the gasket aside to reseal the quartz tube when you reinstall the quartz tube after cleaning.
6	Grasp the quartz tube and pull straight up. Inspect Quartz Tube: If cracks in the quartz tube are found, the tube should be replaced. Broken quartz tubes will allow water to enter the dry electrical chamber and attack the electrical components of the unit, which will cause them to fail and need to be replaced. BROKEN QUARTZ TUBES, OR WATER DAMAGE CAUSED BY BROKEN QUARTZ TUBES, ARE NOT COVERED UNDER YOUR LIMITED WARRANTY.
7	The quartz tube exterior can normally be cleaned by using acid or spirit vinegar or Muriatic Acid (liquid) with weak concentration. (ratio of 4 parts water to one part acid) CAUTION: Follow the directions for use and handling of Muriatic Acid on the acid bottle label, being careful to protect your eyes, wear rubber gloves, and avoid breathing fumes Do not use abrasive cleaners. Change the quartz tube if necessary.
8	 Seat the quartz tube DELICATELY into the receptor at the bottom of the wet chamber (Without dropping it). The quartz tube will not go all the way down into the wet chamber, approx. 1" will be showing after the rounded end of the quartz tube is seated in the receptor at the bottom of the wet chamber. Take a new sealing gasket (angled seal). (Put a new sealing gasket every lamp change) Place it on the end of quartz tube (angle downwards).
9	Install and tighten the black plastic mounting gland. Do not over tighten. Be careful not to cross thread the plastic nut.
10	Reinstalling The UV Bulb Seat the bulb end cushion on the end of the bulb (the end that goes down into the quartz tube first). Place the two O-Rings around the top white porcelain bulb end cap (where the electrical pins are located). SLOWLY lower the bulb down into the quartz tube.
11	Without forcing, plug the UV lamp to 4 pin connector (attached to the ballast wires).
12	Reinstall the plastic electrical enclosure bonnet by screwing the 4 mounting screws
13	Plug in Delta UV unit. Turn on the circulation pump. (Lamp will not come on without water pressure). Verify that the bulb is lit by viewing the glow of the bulb through the clear plastic union.

WINTERIZING

Your DELTA UV unit can be damaged if allowed to freeze. The substantial pressure inside the wet chamber caused by ice forming inside the wet chamber can break the glass quartz tube as well as the wet chamber itself. Therefore, you must protect your DELTA UV unit from freezing.

Damage due to freezing, including breakage of glass components, the wet chamber, or water damage to other components caused by freezing **IS NOT COVERED** under your Limited Warranty.

Freeze damage - Freeze damage can be avoided by keeping the water flowing at a minimum of 5 PSI pressure (as noted on the operating pressure gauge) at all times, without interruption during freezing temperatures. All time clocks must be inoperable and the pump must run continuously. Freeze damage can also be avoided if the pump and DELTA UV unit are maintained inside a warm enclosure.

Freezing Weather Precautions - If you do not plan to operate your DELTA UV unit during freezing temperatures, you must take precautions to make sure all water is removed from inside the DELTA UV wet chamber so it does not freeze inside the wet chamber and damage the quartz tube, acorn nut(86-02411), and DELTA UV unit. This can be accomplished by first closing any valves on lines in the plumbing system and then open the inlet union at the bottom of the DELTA UV unit so that the water is drained from inside the wet chamber tank. Remove Quartz tube (see Section F) and store in safe location. A safe precaution is to place the DELTA UV unit in a warm location during freezing temperatures (**recommended**), after draining all the water from the unit and removing it from the plumbing. Caution: A drain valve and piping to carry water away from the DELTA UV unit must be installed if drainage of the DELTA UV unit will cause water damage to the area surrounding the DELTA UV installation.

E/ES SERIES

MODEL	POWER	LAMP	QUARTZ TUBE	BALLAST	UV HOUSING
		ITEM#1	ITEM#2	ITEM#3	ITEM#14
E OR ES-5	35W	70-18405	58-50305	70-10405	N/A
E OR ES-10	45W	70-18410	58-50310	70-10405	N/A
E OE ES-15	55W	70-18510	59-50315	70-10405	N/A
E OR ES-20	90W	70-18420	58-50320	70-10420	N/A
E OR ES-40	110W	70-18440	58-50340	70-10420	N/A

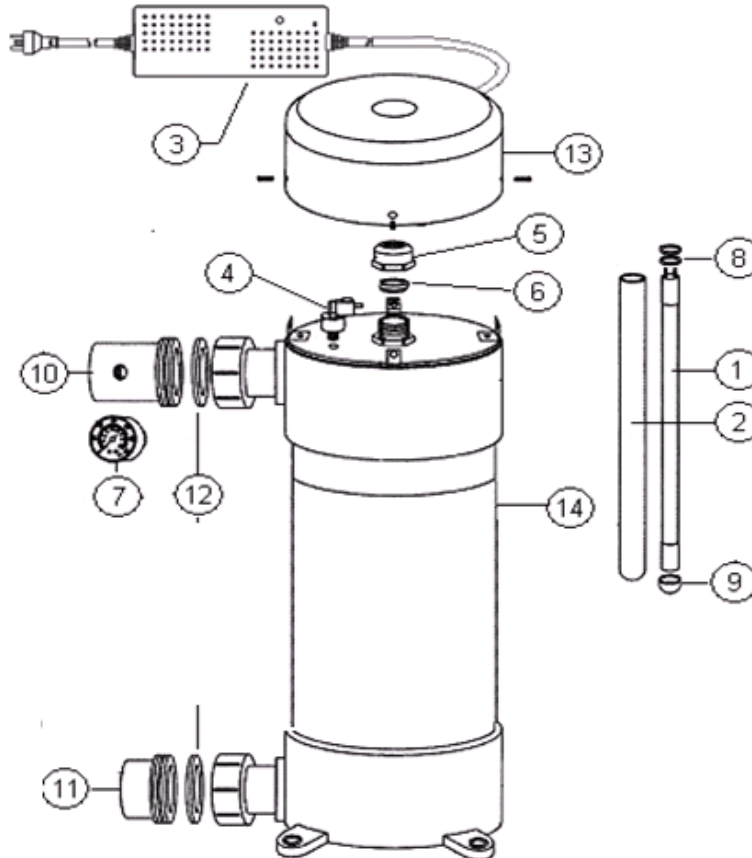

COMMON PARTS

ITEM	DESIGNATION	REFERENCE
4	PRESSURE SWITCH	70-02315
5	QUARTZ TUBE ACORN NUT&HOLDER	86-02411
6	QUARTZ TUBE COMPRESSION GASKET	44-02018
7	PRESSURE GAUGE	84-82234
8	O-RING VITON	44-02221
9	BULB CUSHION	44-02019
10	UNION TAIL PIECE 2" CLEAR	86-02402
11	UNION TAIL PIECE 2" WHITE	86-02352
12	FLAT O-RING 2" WHITE	44-02335
13	ELECTRICAL ENCLOSURE BONNET	86-02064

G. FAQ

Here are a number of FAQ's that will answer some of the most common questions.

Is the Delta UV System Designed For Salt Water Use? – While the ability of the system is not affected by salt water, the harsh environment found in salt water ponds and aquariums is not recommended for the ES Series units due to the stainless steel inner wrapper. However, the all plastic E-Series units are compatible with salt water environments.

Do I Need To Turn My DELTA UV Unit Off When I Clean My Filter? - No, the flow sensing pressure switch that is part of your DELTA UV unit will automatically shut the UV bulb off until proper water flow inside the DELTA UV unit is re-established. Should you need to turn your unit off for any reason, this is accomplished by simply unplugging the DELTA UV unit from its power outlet.

Will A Time Clock On My Pool Shorten My Bulb Life? - Some shortening of the bulb life can be expected when the DELTA UV unit is turned off and back on frequently. A daily on/off cycle will not create a major bulb life issue however, frequent on/off cycles should be avoided.

Is There Any Residual Effect From UV? - **No**, UV light is used as a control and is applied only to the water that passes inside the DELTA UV wet chamber in visual contact with the UV transmission from the UV bulb.

Can The DELTA UV Unit Be Mounted Horizontally? - **No**, vertical mounting is required to maintain the weatherproof integrity of the electrical enclosure bonnet.

Can The DELTA UV Unit Be Installed Below The Pond or Pool Waterline? - The DELTA UV unit has a pressure switch that controls the on/off cycle of the UV bulb when the pump stops or starts. If the DELTA UV unit is installed (example, in a vault below the waterline of the pond or pool), a static head of water pressure may be sufficient to cause the pressure switch to remain closed, which means that the UV bulb will remain lit at all times while the DELTA UV unit is plugged into its power source. Contact Delta UV or your supplier for a different type of pressure switch (Part # 70-02305) that can be adjusted to allow for this static water pressure in the DELTA UV wet chamber. Installation of this type of pressure switch takes only a few minutes and will restore the desired ability of the bulb to be turned off automatically when pumping is interrupted. **DO NOT OPERATE YOUR UNIT WITHOUT A PROPERLY WORKING PRESSURE SWITCH.**

Can Multiple Units Be Used Together For Larger Systems? - Yes, you can add any number of DELTA UV units to a plumbing bypass manifold system to allow for larger outputs and flow rates beyond the capacity of a single E-40 or ES-40 unit. Delta UV also manufactures a large capacity system, the EM UV system, that incorporates factory installed hydraulically balanced piping and multiple tanks contained within a metal enclosure. The EM system features the latest technology in high output UV bulbs, dubbed Amalgam bulbs. Contact Delta UV or your supplier for information on the EM product line, or to obtain a drawing showing the proper method of plumbing multiple DELTA UV units for larger applications.

Must I Use A GFCI (Ground Fault Circuit Interrupter) With My UV Unit? - Yes. A 15 Amp 120V GFCI can be factory installed in your DELTA UV unit at time of manufacture (optional), or you can install it in the electrical receptacle that is used to power your DELTA UV unit. Additionally you can install it in the electrical panel (GFCI breaker) that services the electrical circuit of your DELTA UV unit, or if you want to install the field retrofit weatherproof cord connected GFCI, it is easily installed on the end of the DELTA UV unit's electrical power cord. Installation is simple and takes only a few minutes by following the simple directions supplied. No special tools are required. You can order the cord connected GFCI kit (Part # 70-09012) from your supplier or from Delta UV.

Can the Delta UV system be installed on a new or re-plastered pool immediately? – Yes, however the quartz tube may require cleaning more frequently due to conditions of water caused by the conditioning of the plaster.

H. TROUBLESHOOTING

The UV Bulb Will Not Light - If this occurs upon initial start-up, the problem could be caused by a number of issues.

- a. The pressure switch is open. This is caused by low pressure in your system. Make sure the pump is on (the bulb will only light when there is .5 psi water pressure inside your DELTA UV unit's wet chamber). Verify that the pressure gauge reads 5 PSI or more. If it does not read at least 5 psi, reduce flow exiting the DELTA UV unit by partially closing the valve on the discharge piping exiting the DELTA UV unit. This will increase the pressure inside the DELTA UV wet chamber. - A low pressure 1/2 psi pressure switch (P/N 70-02305) is also available and can be installed in lieu of the 5 psi pressure switch supplied.
- b. The bulb has become disconnected from the bulb connector. Disconnect the power cord from the electrical outlet, open the electrical enclosure bonnet and confirm the bulb connector is firmly in place. At the same time, check all exposed wires for a possible loose connection. Plug the electrical cord back into the electrical outlet ONLY after the electrical enclosure bonnet has been re-installed on the DELTA UV unit.
- c. Verify that the electrical cord is plugged into an energized outlet. Test the electrical outlet. You should confirm the availability of the same power as indicated on the electrical label on your DELTA UV unit.
- d. Make sure you have not plugged your unit into any power source other than that specified on your unit's electrical label. If you have done so in error, the ballast has been damaged and needs to be replaced. Contact your supplier for the correct replacement ballast. (Not warranted)

The UV Bulb Is No Longer Lit - This occurs after the unit has been operating successfully for a period of time

- a. The bulb has burned out. Replace the UV bulb.
- b. The ballast has burned out. Contact your supplier or Delta UV for assistance in obtaining a new ballast.
- c. Verify that the electrical outlet where the DELTA UV unit is plugged into has the proper voltage and the cord is securely plugged into the outlet.
- d. Verify that the GFCI has not tripped. To verify the operating state of the GFCI, trip the GFCI manually and reset it manually. The GFCI should reset. If it does not, see section below on GFCI

The UV Bulb Stays Lit When The Pump Is Off - The DELTA UV unit is equipped with a safety pressure switch that turns the UV bulb off when the pump is turned off. This function guards against having the bulb lit accidentally when the electrical enclosure bonnet is removed and serves to ensure that there is water flowing in the DELTA UV unit wet chamber to cool the bulb and extend its life.

- a. If the DELTA UV unit is located below the water level of the pond or pool, there is a static head of water that causes pressure to be found inside the wet chamber. This static head of pressure closes the pressure switch and the bulb stays lit even when the pump is off. Contact your supplier or Delta UV to obtain a special pressure switch that can be adjusted to allow for the static head of water.
- b. If the DELTA UV unit is located above the water level of the pond and the bulb stays lit when the pump is off, replace the pressure switch.

The Water Is Green - Green water is an indication that the UV rays generated by the DELTA UV unit are not effective or are not being generated by the UV bulb.

- a. Check pool chemistry for phosphates and chemical balance.
- b. Check the bulb to make sure it is on. If it is not on, follow the procedures above regarding the UV bulb not lighting.

- c. Run your unit longer. If your unit is operating on a time clock, run the circulation pump longer to allow the DELTA UV unit to function fully.
- d. Clean the quartz tube.
- e. Replace the UV bulb if it is nearing the 13,000 hour useful life. At 13,000 hours of operation, the UV bulb is 80% as effective as it was when it was new. This is normal for all low-pressure type UV bulbs, which are the longest life bulbs used in this type of application.

The GFCI Has Tripped - The GFCI protects the system from any fault to ground, as the electrical breaker protects the electrical circuit. When it trips, it is an indication that there is an electrical problem that must be corrected to provide a safe operating environment in your pool or pond.

- a. GFCI Not On End Of Power Cord - Disconnect the DELTA UV unit from the electrical receptacle. Reset the GFCI at the breaker panel or at the receptacle. If the GFCI does not reset, replace the GFCI. If the GFCI does reset, plug the DELTA UV unit into the electrical receptacle and make sure the pump is on. If the GFCI trips, it is an indication that there is a ground fault inside the DELTA UV unit. Follow instructions previously given for opening the electrical enclosure bonnet and inspecting the DELTA UV unit.
- b. GFCI Is On End Of Power Cord – Try to reset the GFCI – If the GFCI won't reset, inspect the power cord for fraying or damage and if none is found, unplug the power cord from the electrical receptacle.
- c. If water is present inside the electrical enclosure bonnet, it will trip the GFCI. Following instructions given previously, remove the quartz tube, inspect it for cracks or breakage or for a bad quartz tube seal. Re-seal the quartz tube.
- d. Regardless of where your GFCI is located, you can check the UV bulb for GFCI trip cause by unplugging the bulb from the bulb connector, then place the electrical enclosure bonnet back on the DELTA UV unit and power up the circulation pump. Reset the GFCI and if it does not trip, it indicates that the UV bulb is causing the fault to ground. Replace the UV bulb. If the GFCI does not reset, then the problem is with the Ballast. Replace the ballast.

The DELTA UV Unit Makes Noise When Operating - This is an indication of the DELTA UV unit not being properly attached to a firm mounting base of wood or concrete with the bolts placed through the mounting holes in the DELTA UV unit base. It can also indicate that the UV bulb was installed without the required bulb cushion and/or bulb O-Rings. Attach the DELTA UV unit correctly to a firm base as described in **Sec. D**, or install the bulb cushion and/or bulb O-Rings as described in **Sec. G**.

Water Is Coming Out Of Electrical Enclosure - Water exiting the unit through the electrical enclosure bonnet can be attributed to either (a) a bad quartz tube seal, or (b) a broken or cracked quartz tube. Check the quartz tube seal and quartz tube as instructed in **Sec. G**.

Specifications - Due to Delta UV's commitment to product improvement, all product descriptions or specifications are subject to change without notice.



DELTA UV LIMITED WARRANTY **3 Year - 2 Year**

Delta Ultraviolet Corporation warrants to every original Purchaser of Delta UV's Series Ultraviolet Unit, that the product will be free from defects, as defined herein, for a period of either three (3) years - (ES-Series) or two (2) years - (E-Series). If at any time during the Limited Warranty period, any defect, as defined herein, prevents the product from performing correctly in an application for which it was designed, Delta UV will repair or replace the product (at Delta UV's option) as outlined herein:

COVERED WARRANTY ITEMS:

This Limited Warranty **DOES** cover the UV unit, its components, and defects thereof against:

- Manufacturing Defects
- Material Defects – Ballast, Pressure Gauge, Pressure Switch (1 year)
- Housing Corrosion Causing Leakage (ES Series)
- Plastic Component Degradation
- Bulb failure during 1st year (Pro Rated)

NON-COVERED WARRANTY ITEMS:

This Limited Warranty **DOES NOT** cover the following UV unit defects:

- Failure Of Any Covered Condition When Caused By Any Of The Following:
 - Metal Corrosion Due To Salt Water Use
 - Glass Component Breakage
 - Bulb Failure After One Year
 - Operation At Pressures Greater Than 40 PSI (3 Bar)
 - Any Failure Not Indicated As "Covered Warranty Item" Herein
 - Mechanical Abuse
 - Improper Installation
 - Acts of War or God
 - Freeze Damage
 - Improper Operating Voltage

Note 1: During the duration of this Limited Warranty, should any failure occur, the unit should be inspected at the site to determine the cause of failure, and if that failure is shown to be a covered item, the Original End User (User) must request a written Return Goods Authorization (RGA) from Delta UV, prior to any product return. Any returned unit is to be accompanied by Delta UV's RGA and is to be returned freight prepaid to Delta UV for Limited Warranty evaluation. The User is responsible for any freight damage associated with such return. Unit failures, or components thereof, found to be covered under this Limited Warranty will be repaired or replaced (at Delta UV's option) without cost to the User and will be returned to the User via UPS Surface, at the User's expense. Delta UV shall be the sole judge in determining the cause of failure of any UV unit. Units arriving in broken condition will not be warranted.

The term "Original End User" (User) shall mean the person or company that was in possession of the physical location where the UV unit was originally installed, at the time of first installation, as evidenced by an original invoice from the selling company to the User at the location where the unit is to be returned. A photo copy of said original invoice must accompany the UV unit RGA paperwork. UV units received unaccompanied by the required documentation will not be accepted by Delta UV for Warranty evaluation and will be returned to the User in the same condition as received, freight collect (COD) if the User fails to provide the required documentation within ten (10) days from date of notification of missing documentation from Delta UV. Any unit returned to Delta UV COD or freight collect will be rejected from the freight carrier.

Note 2: This Warranty is Limited in that it does not cover any monetary reimbursement for freight charges, for removal and/or installation labor, or any other incurred costs by any other person(s) or firm(s), including (but not limited to) any consequential damage or loss of use that might be claimed. The Limited Warranty period shall commence upon the date of sale to the User, but in all cases no later than one hundred twenty (120) days after the date of manufacture of the UV unit, as shown on the Delta UV date code located on the product identification label, whichever occurs first. UV units received with factory identification missing, mutilated or altered, or units received containing components not supplied by Delta UV or modified in any way, will not be warranted under any circumstances.

OTHER RIGHTS - This Limited Warranty supersedes any and all previous Limited Warranties for this product, gives you specific legal rights, and you may have other rights which vary from state to state.

DELTA ULTRAVIOLET CORPORATION
CORPORATE HEADQUARTERS
1535 West Rosecrans Ave
Gardena, CA 90249
Phone 310-323-6400
Fax 310-323-6403

REFERENCE INFORMATION

DEALER.....
.....
.....
.....

PHONE.....

CONTACT.....

DATE OF INSTALLATION.....

MODEL.....

RE-LAMP DATE..... RELAMP DATE.....

RE-LAMP DATE..... RE-LAMP DATE.....

RE-LAMP DATE..... RE-LAMP DATE.....

- NOTES -