

- Excessively high chlorine levels can cause corrosion damage to pool fixtures and equipment.
- For maximum cell life, maintain water in a balanced condition. Water maintained in a scaling condition will shorten cell life and may render the Digital Nano/Nano+ inoperative. Damage and/or service calls, caused by improper water balance, will NOT be covered under the equipment warranty.
- Scraping or scratching the titanium blade's edge or surface will damage the blade catalyst coating and cause premature failure of the cell... warranty will be voided. Never use any sharp or metallic objects to remove scale.
- Reduced polarity reversing cycle times will reduce cell life, and should only be used due to uncontrollable scale formation on the cell. ALWAYS test and adjust water balance, before attempting scale control via shortening reverse period.
- The Tri-sensor should not be pulled out at an angle, or the flow paddle or flow post may be damaged.

SAVE THESE INSTRUCTIONS

SECTION 3 - OWNER QUICK START & RUN

- 1) Balance the water chemistry according to the water chemistry parameters on page 7 and salt recommendations on page 37. The Digital Nano/Nano+ may be started immediately. The salt reading, however, may initially be inaccurate until the circulation pump has been run for 24 hours to fully dissolve newly added salt.
- 2) Use the UP and DOWN arrow buttons to set the chlorine percentage to 50%.
- 3) During the first two weeks, test the water chemistry parameters every 3-4 days. Adjust chlorine percentage as needed.
- 4) Once ideal chlorine percentage has been determined, follow normal maintenance procedures.

3.1 HOW YOUR DIGITAL NANO/NANO+ WORKS

The Digital Nano/Nano+ is designed to handle the purification needs of residential swimming pools and spas. The amount of chlorine required for proper sanitization will vary based on the pool size and various factors such as water temperature, bather load, exposure to direct sunlight, and special water features.

The system requires a low concentration of dissolved salt (sodium chloride) in the water. The salt concentration level is normally maintained below the taste threshold. The Digital Nano/Nano+ automatically converts the salt into chlorine, which your pool/spa requires to remain sanitized and algae free. The chlorine reverts back to salt after treating the water. Since the salt is constantly recycled, there is minimal loss during a swimming season. However, salt can be lost due to filter backwashing, rain water overflow, leaks, or bather splashing/carry out but not through evaporation.

The water circulation pump must be operating for your Digital Nano/Nano+ to produce chlorine, so run time is one of several key components to maintaining the proper sanitizer levels. Most installations require a minimum of eight (8) hours-per-day pump run time to properly filter and sanitize the water.

3.2 OPTIONAL 863A EXPANSION BOARD ADDITIONAL FEATURES

When the optional 863A Expansion Board is purchased and installed, your Digital Nano/Nano+ will be equipped with a variety of additional features.

Once installed, the new board will support the addition of an automatic pool cover switch (not supplied) that will detect when the pool cover is open or closed. This will allow the Digital Nano/Nano+ to automatically adjust chlorine output when the cover is closed and avoid over chlorination or premature cell depletion.

A 12/24 Hour Clock that allows the user to set personal preference for time display. The Set Time of Day feature can be set to display the correct time zone and/or adjustments for Daylight Saving Time changes. The optional 863A Expansion Board is also equipped with a Lithium battery backup for real time clock.

The Set Purifier Off feature will allow the Digital Nano/Nano+ to be programmed to delay chlorine production if salt will not be added to the pool water for a specified amount of time, from 1-28 days.

More detailed information on these features can be found in section 7.6, Review of Installer, Owner, & Maintenance Menu Programming, on page 23.

3.3 OWNER/OPERATOR CONTROL BUTTONS, CHECK SYSTEM LED, AND AUDIO ALARM

The following is a brief explanation of owner or operator control buttons.

Please Note: This section assumes the installer has already programmed the system for specific site parameters, has established proper water balance, and has pretreated water to 1 - 3 ppm (mg/L) chlorine.

Attention Owner: Should Centigrade vs. Fahrenheit, choice of language, or other owner options require modification, please refer to the programming information in section 7.6, located on page 23.

3.3.1 **UP and DOWN Arrows**

Use the UP and DOWN arrows to control the chlorine output level, then press the SELECT button to save the value chosen. With a properly prepared pool, the recommended starting output level is 50%.

Upon initial start-up, check sanitizer every 3-4 days and make small output level adjustments as necessary to maintain 1 - 3 ppm (mg/L) free chlorine levels. Keep in mind, your Digital Nano/Nano+ does not directly measure or regulate the sanitizer levels in your pool. Rather, the owner / operator will need to periodically test the water to determine the current chlorine level, and adjust the output setting as needed.

After the chlorine output level is “tuned in,” the unit will automatically make fine output adjustments as the water temperature fluctuates. This temperature compensation feature will adjust output depending on water temperature. See section 5.1 on page 10 for more information concerning the Patented Temperature Compensation feature.

Please Note: The optimum output setting will vary based upon pool size, location, exposure to sunlight, number of users, vegetation around the pool, water balance practices, and pump run time. Your installer should have already taken these factors into consideration when performing installation programming. Therefore, your adjustments, at this point, should be relatively minor.

3.3.2 **The BOOST Button**

The BOOST button increases output to 100%. Use this feature when a heavier than normal bather load is anticipated.

Press BOOST once = 24 Hour Boost

Press and hold BOOST for 8 seconds . = 72 Hour Boost

Press BOOST a second time = Deactivate Boost

3.3.3 **MENU and SELECT Button**

The “MENU” button allows the operator access to the “Test Pool Pilot”, “View setup”, “Owner options”, “Maintenance” and “Installer” menus. (For full features of the Owner Options Menu, please see page 23.)

Press the UP and DOWN arrows to scroll through the menus.

The “SELECT” button allows the operator to choose program menu options. The owner / operator should not normally need to access these features on a regular basis.

Consult the Programming section on page 20 or contact factory customer support for additional information.

A graphical overview of all the menus & sub-menus is shown in section 7.2 on page 19.

3.3.4 CHECK SYSTEM Light and Audio Alarm

The CHECK SYSTEM light will flash to warn the unit may need attention. A warning message will also be displayed. If enabled, an audio alarm* may also be heard when the system light is flashing. Unless deemed a normal condition, per below, see the Troubleshooting section on page 42.

- Flashes red when pump is off / water flow is insufficient (It is normal for the light to flash if the circulation pump is off)
- Flashes when salt is low (check salt and add as needed)
- Flashes when water temperature exceeds 125° F (51° C), or drops below 10° F (-12° C)

*Note: When enabled, an audio alarm will sound due to any of the above three (3) conditions. If water flow ceases (or falls below minimum acceptable levels) the alarm will automatically silence after 10 minutes. To enable or disable audio alarm, see section 7.6.13 “Enable/Disable Audio Alarm” on page 26 in the programming instructions.

3.4 NORMAL DISPLAY MODES

The Digital Nano/Nano+ is limited to Purifier Mode.

3.4.1 Purifier Mode

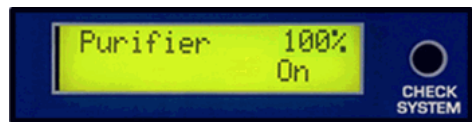
- Purifier (Chlorine Output %) level Shown in 1% increments
- Range with cover open 0% to 100%
 - Range with cover closed 0% to 20%
- Water Temperature Displayed in Fahrenheit or Celsius. The Temperature can be turned off. See section 7.6.7, “Display Temperature” on page 24 for more information.
- CHECK SYSTEM Light Off when operating normally. Normally blinking red when circulation pump is off and supply power to the Digital Nano/Nano+ remains on. The light will also blink red when an error has occurred. Refer to the Troubleshooting section on page 42 for more information.

Example with the Retractable Pool Cover Open and the Temperature Display on.



Cell Status.....will show “on” when chlorine is being generated. Field will be blank when the cell is off.

Example with the Retractable Pool Cover Closed and Temperature Display off.



Display “A”

Display “B”

3.5 WATER BALANCE AND CHEMISTRY RECOMMENDATIONS

Water balance is not complicated. It is the relationship between different chemical measurements in your pool water. A pool that is balanced has proper levels of pH, Total Alkalinity and Calcium Hardness. Balanced water can also be defined as water that is not corrosive or scaling. Water that is not balanced can damage equipment and pool surfaces.

Proper water chemistry levels are essential to maintain safe and consistent swimming pool operation. Sanitizers are used to destroy harmful or otherwise objectionable organisms. Stabilizer is used to prevent unnecessary loss of chlorine to sunlight. Salt is used by the Digital Nano/Nano+ to generate chlorine sanitizer.

Please note the following recommended water chemistry parameters are for residential pool/spa applications only. Follow local regulatory guidelines for any commercial pool applications.

PARAMETER	UNITS	POOL			SPA		
		MIN	IDEAL	MAX	MIN	IDEAL	MAX
Free Chlorine	ppm (mg/L)	1.0	2.0 - 4.0	5	2.0	3.0 - 4.0	10
Combined Chlorine	ppm (mg/L)	0.0	0.0	0.2	0.0	0.0	0.5
pH	ppm (mg/L)	7.2	7.2 -7.8	7.8	7.2	7.2 -7.8	7.8
Total Alkalinity	ppm (mg/L)	60	80 - 100	180	60	80 - 100	180
Calcium Hardness	ppm (mg/L)	150	200 - 400	1000	100	150 - 250	1000
Salt	ppm (mg/L)	2000	2500 - 4500	**	2000	2500 - 4500	**
Cyanuric Acid (stabilizer)	ppm (mg/L)	0	30 - 50	***	0	30 - 50	***

Table 1

** Typically 6000 ppm (mg/L) or less is recommended; unit can operate with levels as high as 35,000+ ppm (mg/L).

*** This is dictated by state or local codes but is typically 100 ppm (mg/L).

See “Basic Water Chemistry” in section 10.1 on page 48, and “Using the Saturation Index” in section 10.2 on page 51 for further information concerning pool/spa water chemistry maintenance requirements. Refer to the Troubleshooting section on page 42 in the back of this manual for assistance with resolving low or high chlorine levels.

SECTION 4 - SPECIFICATION AND APPROVALS

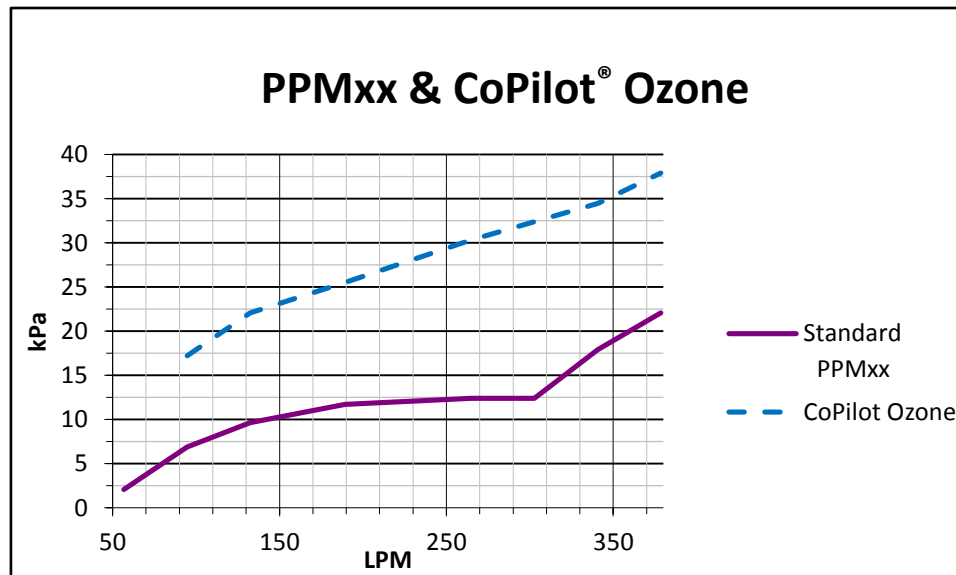
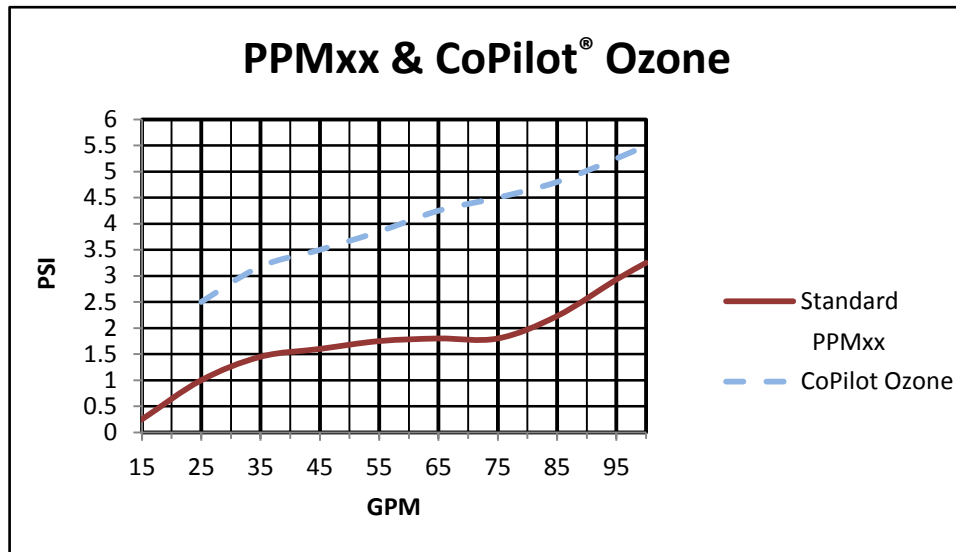
4.1 SPECIFICATIONS

SPECIFICATION	75041A, 75041-XX <i>(when converted to 110V-120V in the field)</i>	75041A, 75041A-XX	75043A, 75043A-XX <i>(when converted to 110V-120V in the field)</i>	75043A, 75043A-XX
Input Power:	110-120 Vac 2.0 A	220-240 Vac 1.0 A	110-120 Vac 2.0 A	220-240 Vac 1.0 A
Cell Maximum Chlorine Output:				
PPC1	0.8 lb. /day (15.1 g/hr.) (standard)		0.8 lb. /day (15.1 g/hr.) (optional)	
PPC2	not applicable		1.06 lb. /day (20.0 g/hr.) (standard)	
Manifold Type	PPM1 or PPM1M		PPM2 or PPM2M	
Standard Cell	PPC1		PPC2	
Manifold Flow rates:				
PPMxx (standard)	Minimum 15 gpm (57 L/min); Maximum 70 gpm (265 L/min)			
CoPilot® Ozone (optional)	Minimum 25 gpm (95 L/min); Maximum 70 gpm (265 L/min)			
Maximum Manifold Pressure:	75 psi (517 kPa)			
Cover Switch Compatible Digital Nano/Nano+ models:	75041A & 75043A (Discontinued models 75040A & 75042A)			

Table 2

4.2 MANIFOLD PRESSURE DROP VERSUS FLOW

The following chart shows pressure drop versus flow for all Digital Nano/Nano+ manifolds. The optional CoPilot® Ozone manifold is also listed. **Table 3**



4.3 AGENCY APPROVALS

Tested to conform to the following specifications:

SPECIFICATION	DESCRIPTION
UL1081	Safety Standard for Swimming Pool Pumps, Filters, and Chlorinators.
CAN / CSA-E60335-1	Safety of Household and Similar Electrical Appliances.
EU	See Declaration of Conformity in section 10.4 on page 53.
FCC	See FCC Compliance Declaration on page 53

SECTION 5 - FEATURES

- Patented temperature compensation for chlorine output control.
- Programmable microprocessor control.
- Multi-language digital display (English, Spanish, French, German, Italian and Czech).
- Digitally controlled power to the cell.
- Tri-sensor circuitry to monitor water flow, water temperature, and salt level.
- Calculates and displays amount of salt needed to reach the recommended 3,000 ppm (mg/L) salt concentration level.
- Compatible with the optional 863A Expansion Board.
- Can automatically reduce chlorine output when pool cover is closed. (Optional 863A Expansion Board and Cover Switch must be installed.)
- Chlorine production (salt addition) can be delayed for up to 28 days.(Optional 863A Expansion Board)
- Lithium battery (CR-2032) backup for real time clock (Optional 863A Expansion Board).
- On board diagnostic and test programs.
- Optional CoPilot® upgrade brings ozone to the pool.

5.1 PATENTED TEMPERATURE COMPENSATION



WARNING: Failure to heed the following may result in permanent injury or death.
Pool or Spa water temperature should not exceed 104°F (40°C).

The Tri-sensor temperature sensor works in conjunction with the chlorine % feature to automatically adjust chlorine output based upon changes in water temperature. The automatic compensation feature operates between 55°F and 125°F (13°C - 52°C).

As water temperature falls below 65°F (18°C), the controller will automatically reduce the chlorine % and will reduce the maximum % that can be selected. This feature prevents the controller from generating excessive chlorine in cold water where it is not needed and prevents premature cell failure.

At 55°F (13°C) or colder water temperatures, the controller will adjust to a fixed 1% output, thus preventing over-chlorination and premature cell failure.

5.2 WATER MANIFOLDS ASSEMBLIES - AVAILABLE OPTIONS



CAUTION: Failure to heed the following may result in equipment damage.
The Digital Nano manifold may only use the PPC1 cell. The Digital Nano+ may use either the PPC1 or PPC2 cell.

The Digital Nano uses the patented automatic-flow bypass manifold assembly (models PPM1, PPM1M). The Digital Nano should ONLY use the PPC1 cell.

The Digital Nano+ uses the patented automatic-flow bypass manifold assembly (models PPM2, PPM2M) with a PPC2 cell. The Digital Nano+ may also use a PPC1 cell but the maximum chlorine output will be lower. See the Specifications table in section 4.1 on page 8.

The CoPilot® manifold assembly comes with an automatic-flow bypass, check valve assembly and ozone injector venturi assembly.

5.2.1 Automatic-Flow Bypass Manifold Assembly (models PPM1, PPM1M and PPM2, PPM2M)

The AutoPilot® patented manifold is connected into the plumbing after all other equipment. Water from the pool/spa is moved through the manifold by the circulation pump. The manifold uses four key components:

- The **Tri-sensor** provides data (from electronic sensors) to the Digital Nano/Nano+ for monitoring water flow, water temperature, and salt concentration level. The Digital Nano/Nano+ uses this data to determine if conditions are suitable for the cell to operate; the signal read from the temperature sensor allows the automatic temperature compensation feature to function.
- The **Cell** (PPC1 or PPC2) receives power from the Digital Nano/Nano+ and converts the salt contained in the water to chlorine.
- The **Strainer Screen** prevents debris in the water from entering the Tri-sensor or cell, and requires periodic inspection and cleaning.
- The **Bypass Check Valve** allows the water flow rate to be slowed and optimized through the cell, while permitting the pump to continue to circulate water to-and-from the pool/spa at full flow rates. The reduced water flow through the cell results in a more efficient "Super-Chlorination" effect, resulting in improved overall sanitization.

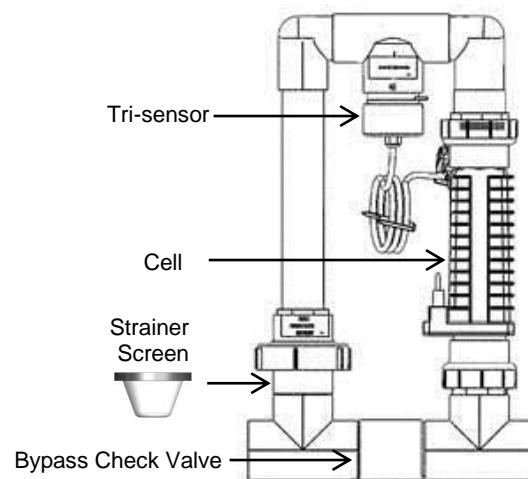


Figure 1

5.2.2 CoPilot® Manifold Assembly

The CoPilot® system is designed to be used in conjunction with the Digital Nano/Nano+ to reduce chlorine demand and extend cell life. This system is also sold separately as an upgrade to existing Digital Nano/Nano+ systems.

The manifold is connected into the plumbing after all other equipment. Water from the pool/spa is moved through the manifold by the circulation pump:

- The **Tri-sensor** provides data (from electronic sensors) to the Digital Nano/Nano+ for monitoring water flow, water temperature, and salt concentration level. The Digital Nano/Nano+ uses this data to determine if conditions are safe for the cell to operate; the signal read from the temperature sensor allows the automatic temperature compensation feature to function.
- The **Cell** (PPC1 or PPC2) receives power from the Digital Nano/Nano+ and converts the salt contained in the water to chlorine.
- The **Strainer Screen** prevents debris in the water from entering the Tri-sensor or cell, and requires periodic inspection and cleaning.
- The **Bypass Check Valve** allows the water flow rate to be slowed and optimized through the cell, while permitting the pump to continue to circulate water to-and-from the pool/spa at full flow rates. The reduced water flow through the cell results in a more efficient "Super-Chlorination" effect, resulting in improved overall sanitization.
- The **Ozone Venturi Injector** introduces ozone directly into the water before the Digital Nano/Nano+ cell. The ozone venturi injector is connected to the CoPilot® via an Ozone Check Valve and Tube Assembly (not shown).

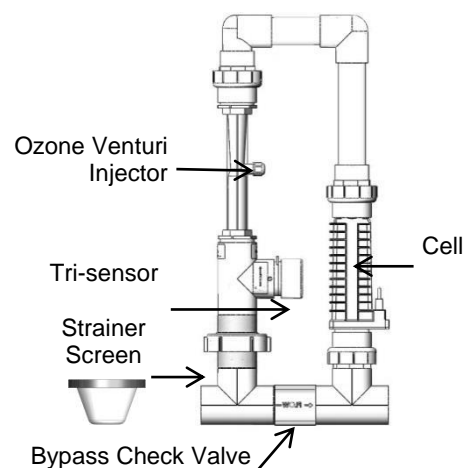


Figure 2

5.3 AUTOMATICALLY REDUCE CHLORINE OUTPUT WHEN POOL COVER CLOSES

When the pool cover is closed, the Digital Nano/Nano+ will automatically reduce the chlorine output to 20% of the normal open cover setting.

*This only applies to models that are equipped with the optional 863A Expansion Board and the cover position switch is connected to the unit. See “Connecting the Retractable Cover Switch” in section 8.6.3 on page 32 for more information.

SECTION 6 - MAINTENANCE

6.1 FUSE LOCATION AND RATINGS

⚠ WARNING: Failure to heed the following may result in permanent injury or death.
ELECTRICAL SHOCK HAZARD – Turn off the electrical power to unit before servicing.

To inspect or service fuse, disconnect power and remove power center cover (see below for location of fuse).

Ratings

BOARD	FUSE SPECIFICATION	DESCRIPTION
Main Power Board When Converted to 115V 75041A, 75043A, 75041A-xx, 75043A-xx	250 Vac 2 Amp Slo Blo	Main AC Power Fuse for 115 Vac operation
Main Power Board (Factory set as 230 Vac) 75041A, 75043A, 75041A-xx, 75043A-xx	250 Vac 1 Amp Slo Blo	Main AC Power Fuse for 230 Vac operation

Location of Fuse

Figure 3

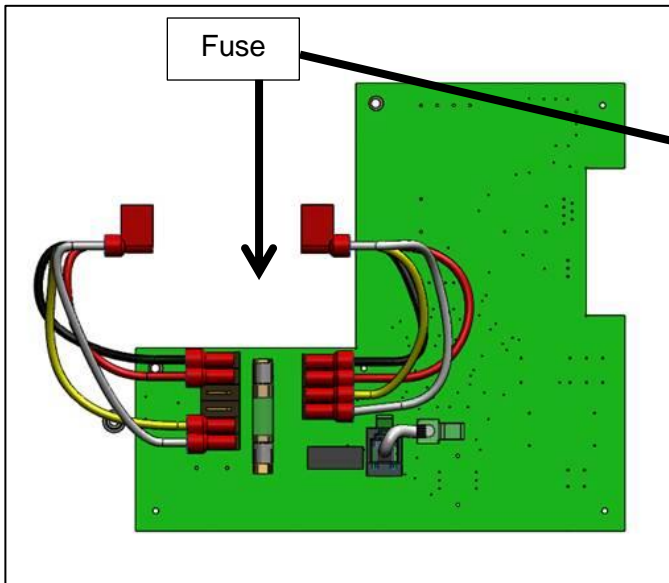
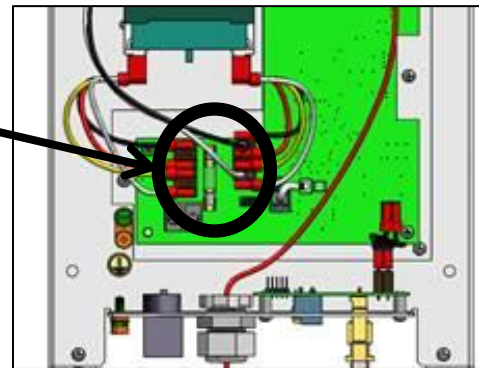


Figure 4



6.2 REMOVING / INSPECTING / CLEANING TRI-SENSOR

6.2.1 *Tri-sensor Assembly Overview*

The Tri-sensor Assembly is used to measure water flow, salt level, and water temperature.

Note: The use of high strength magnet devices in the close proximity of the Tri-sensor can cause the flow switch to function incorrectly.

- When the water flow reaches a minimum flow rate of 15 gpm (76 L/min), the flow paddle magnet closes a micro-switch monitored by the Digital Nano/Nano+. The CoPilot® Ozone manifold requires a minimum flow of 25 gpm (95 L/min).
- The Digital Nano/Nano+ uses dedicated salt sensor blades to measure the level of salt in the water.
- The Digital Nano/Nano+ uses the temperature sensor to determine water temperature. This measurement is required for the Patented Automatic Temperature Compensation feature to automatically adjust chlorine output as water temperature varies. Less chlorine is needed in cold water, so chlorine output is automatically reduced as water temperature drops (avoiding excess chlorine production). Conversely, more chlorine is needed in warmer water, and production is automatically adjusted higher as water temperature increases.
- Please note - The Tri-sensor normally does not require maintenance or cleaning.

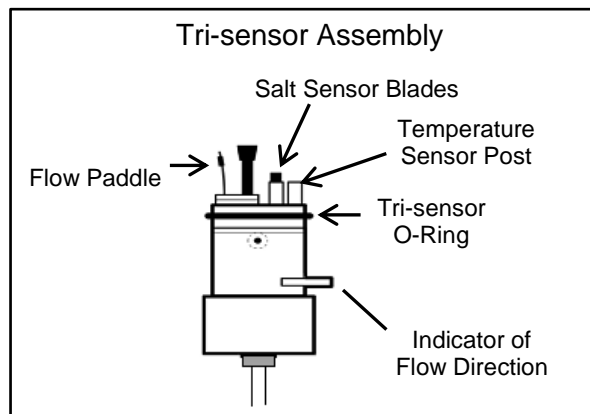


Figure 5

6.2.2 *Inspect Tri-sensor*

- 1) Disconnect the Tri-sensor cable from the power center.
- 2) Remove the two (2) screws retaining the Tri-sensor in the Tee joint of the Manifold.
 - Note the orientation of the Directional of Flow Tab. The Tri-sensor must be installed in the same orientation when it is reinstalled or replaced.
- 3) The Tri-sensor can now be pulled out of the Tee.



CAUTION: Failure to heed the following may result in equipment damage.

The Tri-sensor should not be removed from manifold at an angle, or the flow paddle and/or flow post may be damaged.

- Firmly grip the Tri-sensor assembly (this is typically done with a large pair of channel lock pliers).
 - Twist the Tri-sensor back-and-forth while simultaneously pulling the Tri-sensor straight out of the Tee joint.
- 4) Check the Tri-sensor assembly for any damage to the plastic housing and replace if needed.
 - 5) Inspect the following on the flow switch:
 - Verify the thin metallic paddle is straight and free from erosion.
 - Verify the plastic post is straight and free of cracks. (Do not twist or bend the paddle or the plastic post.)
 - 6) Inspect the two salt sensor blades. The blades should not have any mineral deposits (scale) or other debris on them.

- 7) Do not use any metallic objects to scrape the blade surfaces or you will remove or damage the blade sensor coating.

6.2.3 **Cleaning Tri-sensor/Salt Sensor**

If required, you can remove a calcium scale buildup by creating a solution of water and muriatic acid as follows. Do not use any metallic objects to scrape the blade surfaces or you will remove or damage the blade sensor coating.



WARNING: Failure to heed the following may result in permanent injury or death.
CHEMICAL HAZARD - To avoid damaging splashes always add acid to water, never water to acid. Wear appropriate personal safety protection including safety glasses when using pool chemicals.

- 1) Mix the solution in a small container tall enough to cover the sensor blades. **DO NOT** add water to acids; always add acid to water in container.
- 2) Mix one (1) part muriatic acid into four (4) parts water.
- 3) Immerse the salt sensor blades in the solution for up to 15 minutes. An effervescing action indicates the calcium is being dissolved from the blades.
- 4) Rinse with fresh water and re-inspect. Repeat the acid treatment as necessary until all scale has been eliminated.

6.2.4 **Test Tri-sensor Flow Switch**



WARNING: Failure to heed the following may result in permanent injury or death.
 Do NOT operate system with a faulty water flow switch.

The Flow Switch is a critical equipment protection device to prevent damage to the cell or system. When water flow has stopped, power to the cell is automatically turned OFF. It is important to verify the proper operation of the Tri-sensor's water Flow Switch protection device.

The following procedure can be used to verify the proper operation of the flow switch, or to flush debris from the Bypass Valve.

- 1) Turn off the circulation pump.
- 2) Slightly loosen the union just below the cell on the side of the manifold that does not contain the filter screen. (A strap wrench may be required.)
- 3) Completely loosen the manifold union nut that contains the filter screen and pivot the manifold to gain access to the filter screen.
- 4) Remove the screen. Clean the screen if dirty.
- 5) If the screen was dirty, then the system may need to be purged to remove excess debris. Leave the manifold off and run the pump for a few seconds until clear.

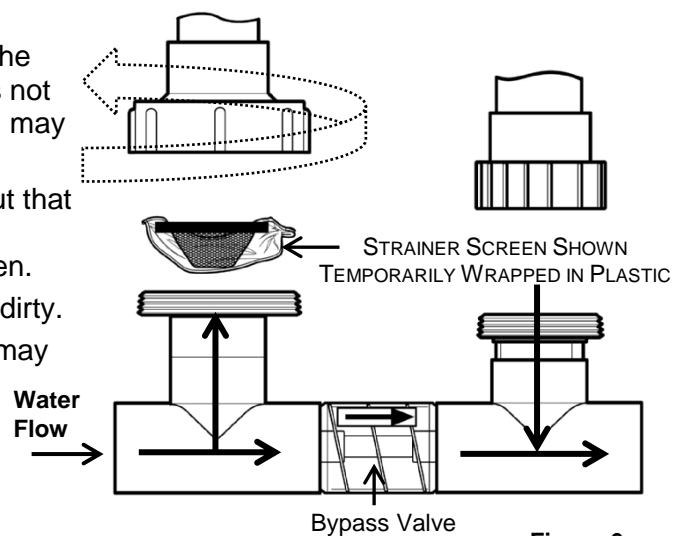


Figure 6

- 6) Wrap the strainer screen securely with a small piece of plastic wrap (saran wrap, food wrap or zip lock bag) as indicated in the diagram, place it back in the union.
- 7) Tighten the two unions that were loosened. Do not over tighten.
- 8) Turn on the pump and the Digital Nano/Nano+. The plastic will stop water flow to the Flow Switch, which is part of the Tri-sensor that is located in the upper portion of the manifold. All water will be forced through the Bypass Valve. (This action will normally flush out any small bits of debris trapped in the Bypass Valve.)
- 9) The Digital Nano/Nano+ should detect a low water flow at the Tri-sensor, and activate the red "CHECK SYSTEM" light. The Digital Nano/Nano+ will also display the message "Error purify off"; "Check flow".
- 10) If the Digital Nano/Nano+ did not display this warning, check the Tri-sensor cable connections and inspect and clean the Tri-sensor as outlined in the "Inspect Tri-sensor" and "Cleaning Tri-sensor" sections on pages 13 & 14. If the warning message still does not appear, then turn the Digital Nano/Nano+ off and contact the factory or your local dealer for assistance.
- 11) Turn the pump off.
- 12) Loosen the unions.
- 13) Remove the plastic wrap and replace the strainer screen. Tighten the unions.
- 14) Resume normal operation.

6.3 SERVICING THE CELL

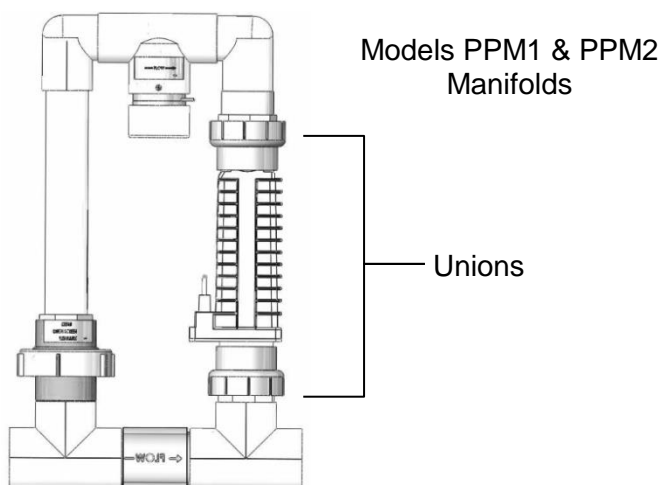
The cell may require removal for periodic visual inspections, or for servicing when debris or calcium mineral deposits develop. The need to inspect and service the cell is indicated by the "CHECK SYSTEM" light flashing and/or a screen message, "Error purify off"; "Check flow" or "warning!"; "Check/clean cell".

6.3.1 Removal

The cell is installed with Unions on each end to allow quick and easy installation and removal.

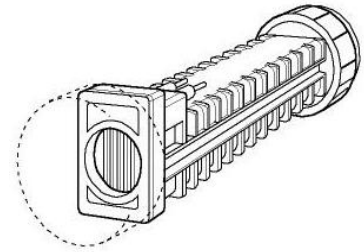
- 1) Turn off pump and shut off all power.
- 2) Detach the cell cable from the cell.
- 3) Unscrew the unions at both ends of the cell. (A strap wrench may be required.)
- 4) Slide the cell out of the Manifold Assembly.

Figure 7



6.3.2 Visual Inspection

Your Digital Nano/Nano+ is designed to automatically self-clean calcium scale build up that may form on the blades during normal operation. However, unbalanced water chemistry can cause a heavy scale build up exceeding self-cleaning capabilities... thus; periodic manual cleaning may be necessary. The simplest way to avoid this extra work is to maintain the water chemistry at the levels recommended.



End view of the cell looking at the blades

Figure 8

- 1) The cell titanium blades, seen inside the cell body, should be straight and clear of any debris on the ends or between the blades.
- 2) White flaky or crusty calcium build up on the edge or between the blades will shorten the life of the cell. If required, clean the cell immediately, and determine the cause of scaling. See "Basic Water Chemistry" on page 48 and "Using the Saturation Index" on page 51.

6.3.3 Manual Cleaning

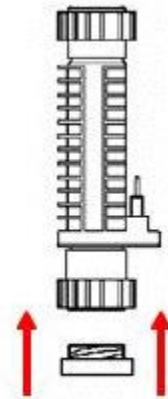


WARNING: Failure to heed the following may result in permanent injury or death.
CHEMICAL HAZARD - To avoid damaging splashes always add acid to water, never water to acid. Wear safety glasses and use other appropriate personal protection equipment.



CAUTION: Failure to heed the following may result in equipment damage.
 Scraping or scratching the titanium blade's edge or surface will damage the blade catalyst coating and cause premature failure of the cell... warranty will be voided. Never use any sharp or metallic objects to remove scale.

- 1) Place a PLA0113 cell cleaning plug (AutoPilot® accessory) on the end of the cell as shown. A 1 1/2" MPT clean out plug may also be used and can be purchased in the PVC plumbing section at most pool supply or home improvement stores.
- 2) Fill the capped cell with water 2 inches from the top of the cell blades.
- 3) Fill the rest of the cell with muriatic acid. This allows for an approximate 1-to-4 solution. Always add the acid to the water. If you do it the other way around, it can cause the solution to spray back causing serious injury.
- 4) Allow the solution to sit in the cell for 20 minutes or until the acid stops bubbling.
- 5) Safely dispose of the solution; pouring it into the pool is recommended.
- 6) Remove the cap and rinse the cell with light water pressure; re-inspect the cell, and repeat acid cleaning if the cell is still scaled.



PLA0113 cell cleaning plug or 1.5" MPT Plug

Figure 9

6.3.4 Installing



CAUTION: Failure to heed the following may result in equipment damage.
 The Digital Nano system is to be used ONLY with a PPC1 cell. Use of any other cell may cause equipment damage and void warranty.
 The Digital Nano+ system can be used with the larger PPC2 or the smaller PPC1 cell (It is normally shipped with the PPC2 cell).



CAUTION: Failure to heed the following may result in equipment damage.
 Ensure that cell cable is fully engaged. Partially seated cable may result in damage to cable or cell during operation.



CAUTION: Failure to heed the following may result in equipment damage.

The electrical terminals must be completely dry to avoid corrosion and failure of the cell or cable.

- 1) Clean and dry the electrical pins on the cell. The contacts must be completely dry to avoid corrosion and failure of the cell or cable.
- 2) Ensure the union O-rings are in place; then place the cell into the manifold with cell pins pointed upward. See Figure 7 on page 15.
- 3) Tighten the unions by hand for a watertight seal. The cell cable has three (3) electrical contact pins. The cell will have two (2) electrical pins. Position the cell plug so the two (2) open holes align with two mating terminals and push gently, but firmly, to connect. Use the red weather plug (supplied) to seal the unused contact in the cable.
- 4) Turn on the system.
- 5) Check for leaks and proper operation.

6.4 WINTERIZING



CAUTION: Failure to heed the following may result in equipment damage.

Special measures are required in the event of freezing conditions. The Digital Nano/Nano+ may be damaged if measures are not taken in advance of freezing conditions. Equipment damage due to freezing conditions is NOT covered under the equipment warranty.

During brief freezing conditions, allow the filtration system to run continuously throughout the freeze period. Circulating (moving) water will not freeze.

In areas where freezing conditions are prevalent and sustained, the equipment must be winterized as follows:

6.4.1 *Digital Nano/Nano+ Control Unit and Manifold Assembly*

- Drain all water from the Manifold Assembly (cell and Tri-sensor), pump, filter, supply and return lines prior to freezing weather.
- The Digital Nano/Nano+ control unit is not affected by the cold and does not need to be removed.

6.5 SPRING START-UP

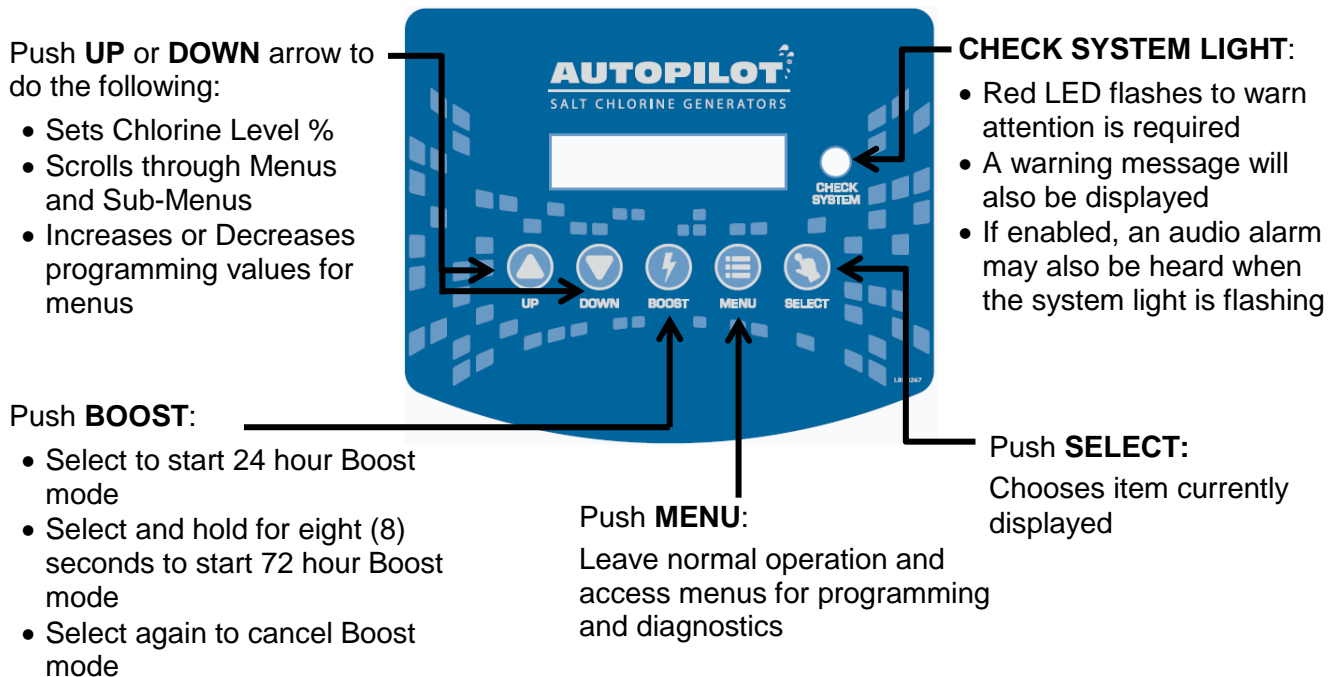
6.5.1 *Digital Nano/Nano+*

It is recommended the water be manually chlorine-shocked when first starting up the pool in the springtime. Test water, and add the appropriate chemicals to balance the pool water per the levels recommended in this manual. See section 3.5, Water Balance and Chemistry Recommendations on page 7. Be sure to check salt and Cyanuric acid (stabilizer), bringing those readings up to the recommended levels. It is also a good idea to inspect the cell, manifold screen, and test the Tri-sensor flow switch; clean and/or replace those items as necessary. See "Maintenance" in section 6, page 12 for instructions.

SECTION 7 - PROGRAMMING

7.1 CONTROL PANEL

7.1.1 *Button Overview*



7.1.2 *MENU Button*

The MENU button is used to leave the normal operation mode and enter the program and diagnostic modes. Use the UP/DOWN arrows and SELECT button to navigate through the menus and sub-menus. Note: to permit quick access to features, some functions are accessed or programmed in several menus.

- Test Pool Pilot - displays various operating parameters and diagnostic results.
- View Setup - displays the programmed setup parameters.
- Owner Options - programs the primary operating parameters an owner would need to change.
- Maintenance Menu - tests and programs the primary features a service technician would need to access when servicing the system.
- Installer Menu - program the initial system setup.

SELECT Button

The SELECT button chooses the displayed menu option. For the “Installer Menu”, press and hold the SELECT button for approximately 13 seconds to access this feature. The SELECT button also temporarily disables the buzzer during an error display.

7.1.3 *Display Overview*

The first line of the display typically indicates Purifier/Chlorine Output Level in percent, or whether the system is in Boost or Super-Boost mode.

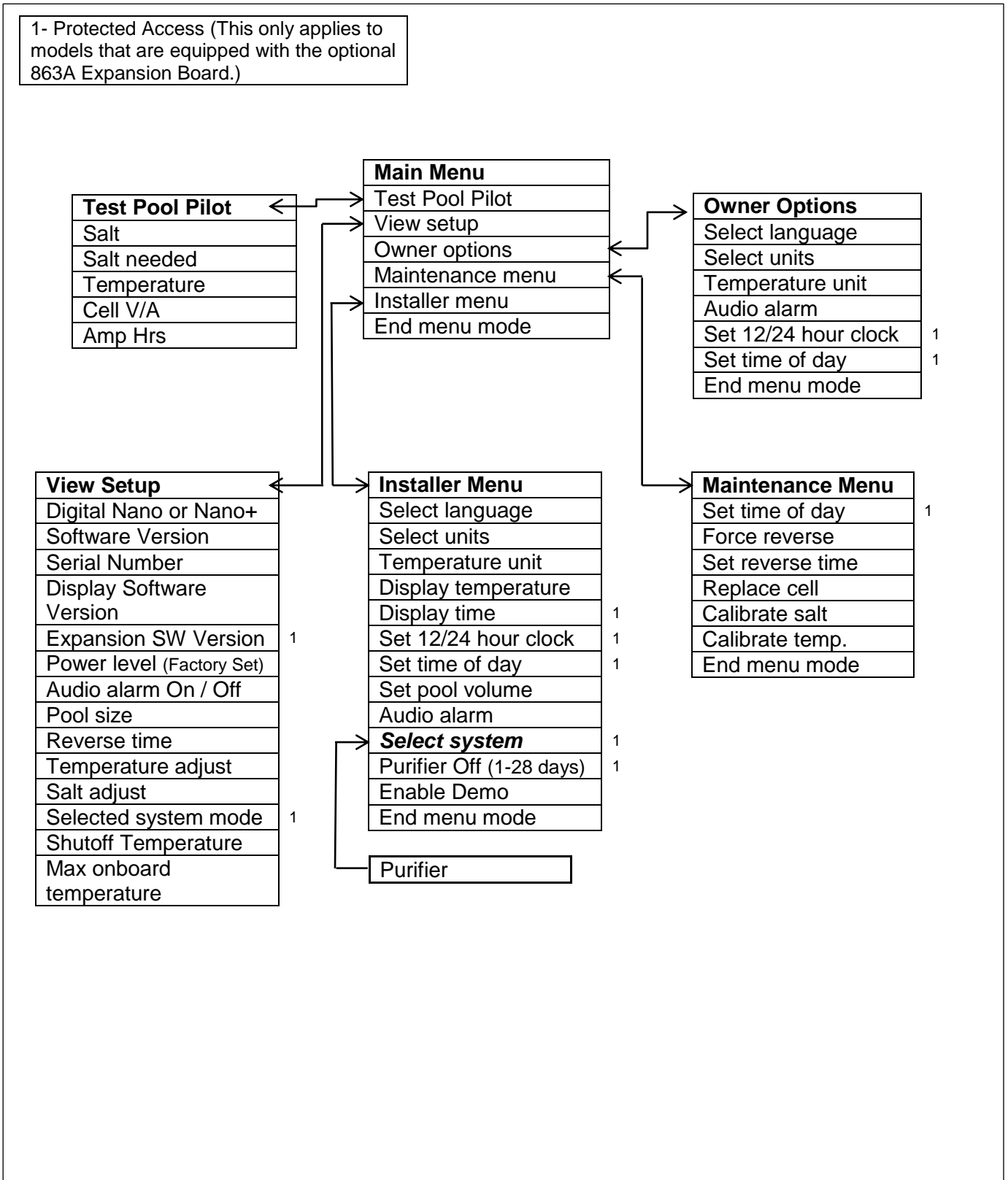
The second line will show the following information:

- If Temperature Display is turned on, the temperature in either ° F or ° C will be shown.
- “On” in the lower right corner will indicate whether the cell is generating chlorine.
- “Cover closed” when the unit detects that the pool cover is closed (purifier/chlorine output will automatically be reduced) on models that have this feature.

A small dot after “On” in bottom right corner indicates the self-cleaning reverse cycle.

7.2 MENUS

Use this overview for quick reference to the menu program sequence. Some menu features will only display with specific System Configurations, as noted below.

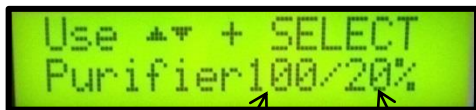


7.3 BASIC OPERATIONAL PROGRAMMING

7.3.1 *Adjusting the Chlorine Output %*

Typically, once the initial setting is established, very little adjustment is needed. The chlorine % setting refers to the amount of time the cell is energized within a 15 minute cycle. The system cycles on-and-off, as indicated on the display's lower right display and "On," when generating chlorine. Higher settings will generate more chlorine.

- 1) Press the UP/DOWN (∇ or Δ) arrow buttons to enter the chlorine adjustment mode. If the optional 863A Expansion Board has been installed along with the Pool Cover Switch, two Purifier % numbers will be displayed. The left one is the value when the pool cover is open and the right is when the cover is closed.



.% When the cover is open % When the cover is closed

- 2) Use the UP/DOWN (∇ or Δ) arrow buttons to adjust the Purifier /Chlorine Output percentage to the desired output: from 0% (off) to 100 % (maximum output when the pool cover is open) and 20% when the cover is closed for models with the optional 863A Expansion Board; then press SELECT to save the new output value and default back to the normal display. At startup of a new system, the standard output setting starting point is 50%.

50% setting = 50% of 15 minutes or 7.5 minutes ON and 7.5 minutes OFF.

25% setting = 3.75 min ON, 11.25 min OFF

Once the percentage is set, the unit will implement the temperature compensation algorithm based on current water temperature.

Refer to section 7.3.4 "Chlorine % Adjustment Procedure" on page 21 for more information.

7.3.2 *Boost or Super Boost*

The Boost feature is used to increase the chlorine % from its normal setting to 100% for a cumulative 24 hour or 72 hour period. When the Boost period expires or is manually terminated, the chlorine % returns to its previous setting and normal operation.

- Boost chlorine output to 100% for 24 hours: From the normal operation mode, press and release the BOOST button. The display will flash: "Boost 24 hour on", then "Boost hh" (with the "hh" actually being the displayed hours remaining in the boost period).
- Boost chlorine output to 100% for 72 hours: From normal operation mode, press and hold the BOOST button until: "Boost 72 hour on" is displayed; then release the BOOST button. Display will show: "Boost" for approximately 8 seconds, after that: "Boost 72 hour on" will display; then, "Boost hh" (with the "hh" actually being the displayed hours remaining in Boost period).
- If an external time clock or controller turns off power to the Digital Nano/Nano+ while Boost is active, the Boost timer is stored in memory and the Boost time countdown will resume when power is reapplied to the unit.
- If water flow is stopped during a Boost cycle, chlorine generation will stop while there is no flow but the Boost timer will continue to count down as long as the Digital Nano/Nano+ has power.

Caution: Regardless of retractable pool cover position, when the Boost feature is activated the unit will increase chlorine production to 100% for 24 or 72 hours based on the Boost time selected.

To exit Boost or Super Boost mode and revert to normal operation:

- Allow the Boost cycle to expire, or
- Press BOOST at any time to manually deactivate Boost.

7.3.3 Chlorine Mode

The Digital Nano/Nano+ will automatically display informative messages about the condition of the Digital Nano/Nano+ (Chlorine output %, water temperature, warning messages, etc.), and responds to manual adjustment of chlorine % setting (as described below). The Digital Nano/Nano+ will revert to the normal display if there is no activity on the keypad for thirteen (13) or more seconds.

7.3.4 Chlorine % Adjustment Procedure

- 1) Balance water chemistry according to necessary water chemistry parameters. See “Basic Water Chemistry” starting on page 48. For new startups, if free chlorine level as tested is not at least 1 ppm (mg/L), add liquid chlorine to ensure 1 to 3 ppm (mg/L) free chlorine reading.
- 2) Add the proper amount of salt as indicated by the Digital Nano/Nano+ (or as described on page 52), and run the circulation pump continuously for 24 hours allowing the salt to be fully mixed and dissolved into the pool. If the salt level is too low, the Digital Nano/Nano+ will provide a warning, and will not generate chlorine until the minimum salt level has been reached.
- 3) Use the UP and DOWN arrow buttons to set the chlorine % to 50%, and then allow the pool to operate normally. If the pool cover is closed, adjust chlorine to 10% rather than 50%.

For the first two weeks, test the water chemistry parameters every 3-4 days. Adjust chemicals as needed to maintain correct water balance.

For the Free Chlorine adjustment, use the following table for fine-tuning the controller output percentage (%):

Table 4

CHLORINE % CURRENTLY SET TO:	IF FREE CHLORINE IS <u>LOWER</u> THAN IDEAL RANGE...	IF FREE CHLORINE IS <u>HIGHER</u> THAN IDEAL RANGE...
0% - 25%	The chlorine % output needs to be increased.	The chlorine % setting is too high.
	Use the UP arrow button to increase the Chlorine Output %. Press SELECT to lock in change.	Use the DOWN arrow button to lower output. Press SELECT to lock in change. The free chlorine will need to be tested frequently and the chlorine output % will need to be adjusted as needed to attain desired level.
25% - 100%	The chlorine % output needs to be increased.	The chlorine % output needs to be decreased.
	Use the UP arrow button to increase the chlorine output %. Press SELECT to lock in change.	Use the DOWN arrow button to decrease the chlorine output %. Press SELECT to lock in change.

After the optimal output percentage (%) has been determined, this setting will not normally require further adjustment. Select a Boost cycle to compensate for increased bather usage or heavy rainfalls (which can both quickly consume chlorine).

7.4 TEST POOL PILOT (DIAGNOSTIC MENU)

Press the MENU button, then press the UP or DOWN arrow until “Test Pool Pilot” is displayed, and press the SELECT button. The display will automatically sequence through the following displays and then return to normal operation. You can also press the UP or DOWN arrow to scroll forwards and backwards. Press the MENU button again to skip the remaining displays and exit back to normal operation. The following information is displayed:

- “Salt = ##### ppm (#.# g/L)” (The optimum salt level is 3000 ppm (mg/L), 4500 ppm (mg/L) for maximum chlorine production)
- “Add salt ## lbs (## Kg)” (The amount of salt needed to maintain 3000 ppm (mg/L))
- “Temperature ##° F (##° C)” (The temperature of the water flowing through the Tri-sensor)
- “Cell = ## V #.# A” (The measured voltage and current sent to the cell)
- “Amp-Hrs = #####” (The amount of current times hours of operation received by the cell)

7.5 VIEW SETUP

A program and parameter menu used to view the currently programmed settings.

Press the MENU button, then press UP or DOWN arrow until “View Set Up” is displayed and press the SELECT button. The display will automatically sequence through the following displays and then return to normal operation. You can also press the UP or DOWN arrow to scroll forwards and backwards. Press the MENU button again to skip the remaining displays and exit back to normal operation. The following information is displayed:

- “Nano” or “Nano+”
- “Software v #” (The version number of main board software)
- “Serial #” (The Digital Nano/Nano+ serial number)
- “Display v #” (The version number of Display Board software)
- “Expansion v#” (The version number of the Expansion Board software)
- “Power level” (The amperage driven to the cell. Set by the factory to 5A)
- “Audio alarm On/Off” (Set by the factory to off. See page 26)
- “##, ### gallons (liters)” (The pool volume programmed in Installation Menu; 15,000 (60,000 liters) is the factory setting. See page 23.)
- “Reverse = # hrs.” (The reverse rate programmed in Installation Menu: 4 hrs. is factory setting. See page 25.)
- “Temp. adjust = #” (The temperature adjustment variation of actual Tri-sensor reading; see “Calibrate Temperature” on page 23)
- “Salt adjust + #” (The salt calibration adjustment variation of actual Tri-sensor reading; see “Calibrate Salt” on page 23)
- “Purifier” (The system mode selected. Purifier is the factory setting –See page 26.)
- “Shutoff Temp” (Internal temperature of the unit at which it goes into a 5 minute cool-down period.)
- “Max temp” (Maximum internal temperature reached)

7.6 REVIEW OF INSTALLER, OWNER, & MAINTENANCE MENU PROGRAMMING

Note: Once determined to be appropriately programmed for the installation site, the following menu items should not require regular access. See “Basic Operational Programming” on page 20 for setting the initial Chlorine Level and routine control instructions.

7.6.1 Set Pool Volume

The pool volume must be programmed for the “Add salt ### lb (kg)” display to be accurate.

- 1) Press MENU, press ∇ or Δ until “Installer menu” is displayed; then press and hold SELECT for 13 seconds.
- 2) Press ∇ or Δ until “Set pool volume” is displayed; then press SELECT.
- 3) Factory setting is 15,000 gallons (60,000 Liters). The range is 500 to 125,000 gallons (2,000 to 500,000 Liters).
- 4) Press ∇ or Δ until correct pool size is displayed; then press SELECT.
- 5) Press ∇ or Δ until “End menu mode” is displayed; then press SELECT.

7.6.2 Calibrate Salt

Note: The unit has been calibrated at the factory and should not require further adjustments. In the event the salt display does not match on-site test results, follow these steps (it is necessary to wait 2 minutes after water flow has started before calibrating salt):

- 1) Press MENU, Press ∇ or Δ until “Maintenance Menu” is displayed; then press SELECT.
- 2) Press ∇ or Δ until “Calibrate salt” is displayed; then press SELECT.
- 3) Press ∇ or Δ until the number on the display matches the accurately measured pool sample; then press SELECT. The maximum adjustment is $\pm 1,000$ ppm (mg/L).
- 4) Press ∇ or Δ until “End menu mode” is displayed; then press SELECT.

7.6.3 Select Language

Allows for personal preference language display.

- 1) Press MENU, press ∇ or Δ until “Owner options” or “Installer menu” is displayed; then press SELECT.
- 2) Press ∇ or Δ until “Select language” is displayed; then press SELECT (English is the factory setting).
- 3) Press ∇ or Δ until desired option “English language” “Idioma Español,” “Langue Francaise,” “Deutsche sprache,” “Lingua Italiana” or “Cesky Jazyk” is displayed; then press SELECT.
- 4) Press ∇ or Δ until “End menu mode” is displayed; then press SELECT.

7.6.4 Calibrate Temperature

Note: Temperature can only be calibrated 2 minutes after start-up. Used only when it is desired to match the display of the Digital Nano/Nano+ to another on-site thermometer.

- 1) Press MENU, Press ∇ or Δ until “Maintenance menu” is displayed; then press SELECT.
- 2) Press ∇ or Δ until “Calibrate temp.” is displayed; then press SELECT.
- 3) Press ∇ or Δ to adjust temperature UP or DOWN to the desired temperature; then press SELECT. The maximum adjustment is $\pm 6^{\circ}\text{F}$ ($\pm 3^{\circ}\text{C}$).
- 4) Press ∇ or Δ until “End menu mode” is displayed; then press SELECT.

7.6.5 **Select Units**

Used to program the operator's personal preferences for the liquid and weight measurements the Digital Nano/Nano+ will display.

- 1) Press MENU, press ∇ or Δ until "Owner options" or "Installer menu" is displayed; then press SELECT.
- 2) Press ∇ or Δ until "Select units" is displayed; then press SELECT ("English units" is the factory setting).
- 3) Press ∇ or Δ until desired measurement "English units" (gallons and pounds), or "Metric units" (liters and kilograms), is displayed; then press SELECT.
- 4) Press ∇ or Δ until "End menu mode" is displayed; then press SELECT.

7.6.6 **Set Temperature Unit**

Set personal preference for temperature display units (°C or °F).

- 1) Press MENU, press ∇ or Δ until "Owner options" or "Installer menu" is displayed; then press SELECT.
- 2) Press ∇ or Δ until "Temperature unit" is displayed; then press SELECT ("Fahrenheit" is the factory setting).
- 3) Press ∇ or Δ until desired measurement unit "Fahrenheit" or "Celsius" is displayed; then press SELECT.
- 4) Press ∇ or Δ until "End menu mode" is displayed; then press SELECT.

7.6.7 **Display Temperature**

Choose to either show or hide the water temperature on the normal display screen.

- 1) Press MENU, press ∇ or Δ until "Installer menu" is displayed; then press and hold SELECT (approximately 13 seconds) until "Installer menu" is displayed again and is accessible.
- 2) Press ∇ or Δ until "Display temp" is displayed; then press SELECT. ("Show temperature" is the factory setting.)
- 3) Press ∇ or Δ until "Show temperature" or "Hide temperature" is displayed; choose desired option and then press SELECT.
- 4) Press ∇ or Δ until "End menu mode" is displayed; then press SELECT.

Note: Even if the Display Temp feature is turned off, the temperature can be viewed in the "Test Pool Pilot" menu for diagnostic purposes.

7.6.8 **Set 12/24 Hour Clock (Optional Feature w/ 863A Expansion Board)**

Set personal preference for time clock display.

- 1) Press MENU, press ∇ or Δ until "Owner options" or "Installer Menu" is displayed, then press SELECT.
- 2) Press ∇ or Δ until "12/24 hour clock" is displayed, then press SELECT (12 hour is the factory setting).
- 3) Press ∇ or Δ until desired time format "12 hour" or "24 hour" is displayed, then press SELECT.
- 4) Press ∇ or Δ until "End menu mode" is displayed then press SELECT.

7.6.9 Set Time of Day (Optional Feature w/ 863A Expansion Board)

Change the time of day display to correct for time zone or Daylight Saving.

- 1) Press MENU, press ▾ or ▲ until “Owner options”, “Maintenance Menu” or “Installer Menu” is displayed, then press SELECT.
- 2) Press ▾ or ▲ until “Set time of day” is displayed, then press SELECT (Eastern Standard Time is the factory setting).
- 3) Press ▾ or ▲ until the desired hour is displayed, then press SELECT.
- 4) Press ▾ or ▲ until the desired minutes are displayed, then press SELECT.
- 5) Press ▾ or ▲ until “End menu mode” is displayed, then press SELECT.

7.6.10 Set Purifier Off (Optional Feature w/ 863A Expansion Board)

The Digital Nano/Nano+ system can be programmed to delay chlorine production if salt will not be added to the pool water for a specified amount of time, from 1-28 days. The system will automatically start up in the Purifier mode after the user defined time has expired. This feature can be used when starting up a newly constructed or resurfaced pool when salt is not going to be added for a few days. The unit will display normal operating messages, including salt levels, but will not show error messages related to chlorine production or salt levels.

- 1) Press MENU, press ▾ or ▲ until “Installer menu” is displayed, then press and hold SELECT for approximately 13 seconds to enter the Installer menu.
- 2) Press ▾ or ▲ until “Purifier Off” is displayed, then press SELECT.
- 3) Press ▾ or ▲ until the desired amount of days “## Day(s)” is displayed, and then press SELECT.
- 4) The display will flash “Purifier Off; ## Day(s)” three times and then display the next menu option.
- 5) Press ▾ or ▲ until “End menu mode” is displayed, then press SELECT.

The system will now begin to count down and will not generate chlorine until the amount of time chosen has expired.

To turn this feature off before the designated time has elapsed:

- 1) Press MENU, press ▾ or ▲ until “Installer menu” is displayed, then press and hold SELECT for approximately 13 seconds to enter the Installer menu.
- 2) Press ▾ or ▲ until “Purifier Off” is displayed, then press SELECT.
- 3) The days remaining will be displayed; Press ▾ until “0 Day(s)” appears, then press SELECT.
- 4) Press ▾ or ▲ until “End menu mode” is displayed, then press SELECT.

7.6.11 Set Reverse Time

Program the Cell's self-cleaning cycle.

 **CAUTION:** Failure to heed the following may result in equipment damage.

Reduced polarity reversing cycle times will *reduce* cell life and should only be used due to uncontrollable scale formation on the cell. *Always* test and adjust water balance, before attempting scale control via shortening reverse period. See “Using the Saturation Index” in section 10.2 on page 51.

- 1) Press MENU, press ▾ or ▲ until “Maintenance menu” is displayed; then press SELECT.
- 2) Press ▾ or ▲ until “Set reverse time” is displayed; then press SELECT (4 hours is the factory setting).

- 3) Press ∇ or Δ until the desired cycle time (2, 4, 8, or 16 hours) is displayed; then press SELECT.
- 4) Press ∇ or Δ until "End menu mode" is displayed; then press SELECT.

7.6.12 **Force Reverse**

Note: This is a diagnostic tool only, and should not be used unless a problem is suspected. Program the cell to activate a Force Reverse cycle and verify if the system is reversing polarity (self-cleaning). There will be a 40 second delay, after selecting "End menu mode", before reversing takes place.

- 1) Press MENU, press ∇ or Δ until "Maintenance menu" is displayed; then press SELECT.
- 2) Press ∇ or Δ until "Force reverse" is displayed; then press SELECT.
- 3) "Cell reversing" will display temporarily in 40 seconds.
- 4) Press ∇ or Δ until "End menu mode" is displayed; then press SELECT.
- 5) The "." (period) on the end of 2nd line of the display will either appear, or disappear—based on its previous state—to indicate cell power polarity has reversed.

7.6.13 **Enable/Disable Audio Alarm**

Note: If alarm is due to low or no water flow, the Audio Alarm will automatically silence in 10 minutes. Upon restoration of flow, normal Audio Alarm operation will resume.

- 1) Press MENU, press ∇ or Δ until "Owner options" or "Installer menu" is displayed; then press SELECT.
- 2) Press ∇ or Δ until "Audio alarm" is displayed; then press SELECT.
- 3) Press ∇ or Δ until "On or off" is displayed; then press SELECT.
- 4) Press ∇ or Δ until "End menu mode" is displayed; then press SELECT.

7.6.14 **Select System (Optional Feature w/ 863A Expansion Board)**

Used by the installer to set the basic equipment configuration of the system.

- 1) Press MENU, press ∇ or Δ until "Installer menu" is displayed, then press and hold SELECT for 13 seconds.
- 2) Press ∇ or Δ until "Select system" is displayed, then press SELECT (Purifier is the factory setting). The display will show the current configuration.
- 3) Press ∇ or Δ until "Purifier" is displayed, then press SELECT.
- 4) Press ∇ or Δ until "End menu mode" is displayed; then press SELECT.

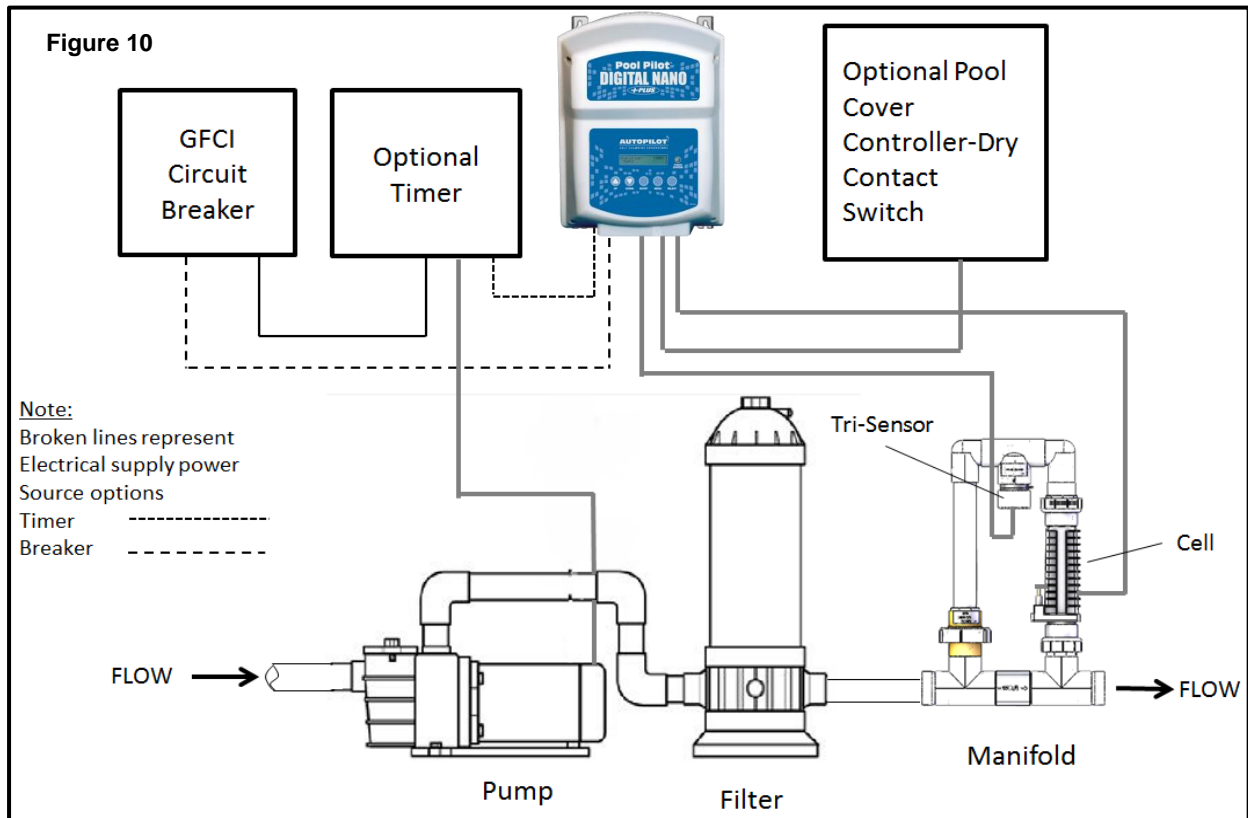
If the optional 863A Expansion Board has been installed, additional options will be displayed that are not supported with this model. **Do not** choose "pH Timed", "pH Probe" or "Total Control":

SECTION 8 - INSTALLATION

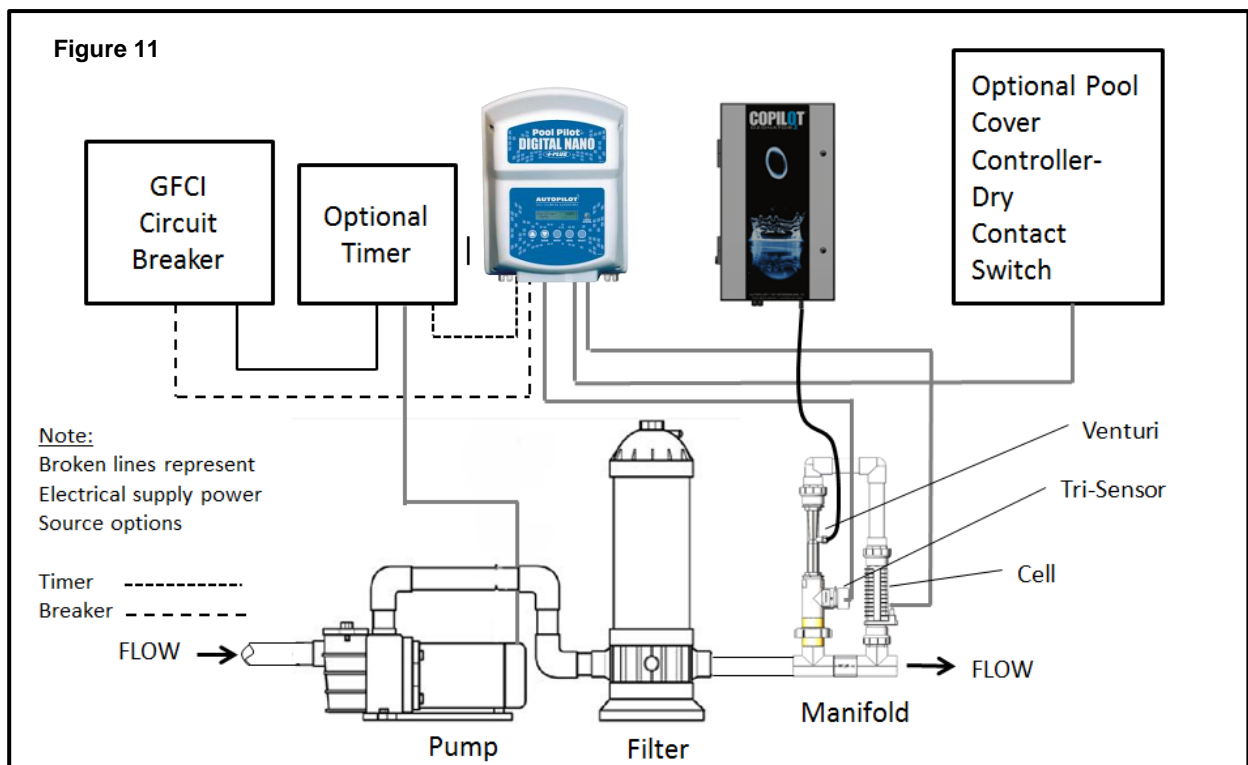
8.1 BASIC SYSTEM OVERVIEW

The Digital Nano/Nano+ is a salt chlorination system for pool or spa purification, and is designed to operate in the following configurations:

SHOWN WITH AUTOMATIC-FLOW BYPASS MANIFOLD ASSEMBLY (models PPM1 or PPM2):



SHOWN WITH OPTIONAL COPILOT® AND COPILOT® MANIFOLD ASSEMBLY:



8.2 PLANNING THE INSTALLATION

8.2.1 Before installing the Digital Nano/Nano+:

- 1) Determine everything needed for installation is on hand.
- 2) Determine where the Manifold Assembly will be plumbed.
- 3) Identify a suitable mounting location for the Digital Nano/Nano+ close enough, less than 12' (3.6 m), to ensure that the cell cord and Tri-sensor cord will reach the manifold components. Plan the routing for the cell and Tri-sensor Cables.
- 4) For the optional retractable pool cover installations with the Digital Nano/Nano+ models. (The 863A Expansion Board must be purchased and installed.)
 - a) Procure/Install dry contact cover position switch in retractable cover controller as needed.
 - b) Plan cable (not provided) run from cover position switch to Digital Nano/Nano+.
- 5) Determine whether the input voltage for the Digital Nano/Nano+ will be 110-120 Vac or 220-240 Vac.
- 6) Plan wire runs and wiring connections for source power.
- 7) Determine origination point for the Digital Nano/Nano+ control center power feed:
 - a) Directly from a circuit breaker. (Circuit breaker is used to power the Digital Nano/Nano+ and circulation pump.)
 - b) From an external timer or an electronic controller. (Digital Nano/Nano+ is to be wired to the same location as the circulation pump; the Digital Nano/Nano+ is activated when the circulation pump is energized.)

8.3 CHECK PARTS

Before attempting the installation, verify the following items have been included with the Digital Nano/Nano+:

Included

QUANTITY	DESCRIPTION
1	220Vac - 5 foot (1.5 m) cord for 220V (pre-installed)
1	Strain relief – ½" (pre-installed 220V only, models 75041A and 75043A)
1	Split gland – ½" (when equipped with 863A Expansion Board. Comes with optional kit #STK0156)
1	Cell cable
4	Plastic anchors
4	Mounting screws
2	Metric PVC adapters (2" spigot x 63 mm socket) (only with metric manifold models)

Table 5

Not included

Power service electrical or bonding wire.
Pool cover controller, dry contact pool cover position switch, or associated cable

Table 6

8.4 INSTALLATION STEPS

Details on each step of the installation process are presented on the following pages:

- 1) Mounting the Digital Nano/Nano+
- 2) Electrical Connections (page 30)
 - Electrical Connections Overview
 - AC Input Voltage
 - Low Voltage Wiring
 - Connecting the Cell Cable
 - Connecting the Tri-sensor
 - Connecting the Retractable Cover Switch (option available with installation of the #863A Expansion Board)
 - Bonding
- 3) Plumbing the System (page 35)
 - Plumbing the Manifold Assembly
- 4) Preparing the Water (page 36)
- 5) Programming at Installation (page 38)

8.5 MOUNTING THE DIGITAL NANO/NANO+



WARNING: Failure to heed the following may result in injury or death.

All electrical connections should be made by a licensed electrician or certified electrical contractor.

Ensure electrical power is disconnected before wiring the unit. Follow all state / local NEC (CEC if applicable) electrical codes. Use copper conductors, only.

The Digital Nano/Nano+ is suitable for indoor or outdoor mounting. When connected to 230 Vac, the Digital Nano/Nano+ control unit must be installed at least 5' (1.5 m) horizontal distance from the pool or spa wall. When connected to 115 Vac, the Digital Nano/Nano+ control unit must be installed at least 10' (3 m) horizontal distance from the pool or spa wall. Greater distances may be required by local codes.

The Digital Nano/Nano+ control unit is designed to mount vertically on a flat surface with the wiring inputs facing downward. The enclosure is designed to allow heat to dissipate from inside the box. It is important the top or bottom of the enclosure is not blocked.

Do NOT mount the Digital Nano/Nano+ inside a panel or a tightly enclosed area lacking proper and full ventilation.

When selecting a location for installing the Digital Nano/Nano+ control unit, please note the Tri-sensor and cell cables are 12' (3.6 m) long.

ATTENTION: Verify the selected Digital Nano/Nano+ location is close enough to the Manifold Assembly to allow the Tri-sensor and cell cables sufficient slack to accommodate later service and maintenance.

To avoid damage to wiring and connectors, read the following section before proceeding:

- 1) Hold the Digital Nano/Nano+ chassis level in the selected mounting location. Through the top, narrow portion of the mounting slots, mark the wall for the four (4) mounting holes.
- 2) Plastic anchors and screws have been provided for concrete or stucco walls; anchors are not required when mounting to wood or composite materials. Drill and install the plastic anchors (as applicable). Tighten the screws into the anchors, temporarily leaving a ¼" (7.0 mm) gap between the wall and the underside of the screw heads.
- 3) Holding the Digital Nano/Nano+ slotted openings to the screw heads, allow the screw heads to pass through the larger portion of the mount holes. Hang the power center on the four (4) mounting screws. Tighten the screws using a long shaft screwdriver.

8.6 ELECTRICAL CONNECTIONS



CAUTION: Failure to heed the following may result in equipment damage.

Connecting 230 Vac to a unit that has been configured to 110-120 Vac will result in permanent damage to the unit. Damage due to incorrect wiring is not covered under the warranty.



WARNING: Failure to heed the following may result in injury or death.

All electrical connections should be made by a licensed electrician or certified electrical contractor

8.6.1 *Electrical Connections Overview*

A high voltage AC input provides power to the control center. Low voltage cables provide power from the Digital Nano/Nano+ control center to the Tri-sensor and cell.

The AC input voltage of the Digital Nano/Nano+ has been preconfigured at the factory.

- Model numbers 75041A, 75041A-xx, 75043A, 75043A-xx have been factory configured for 230 Vac

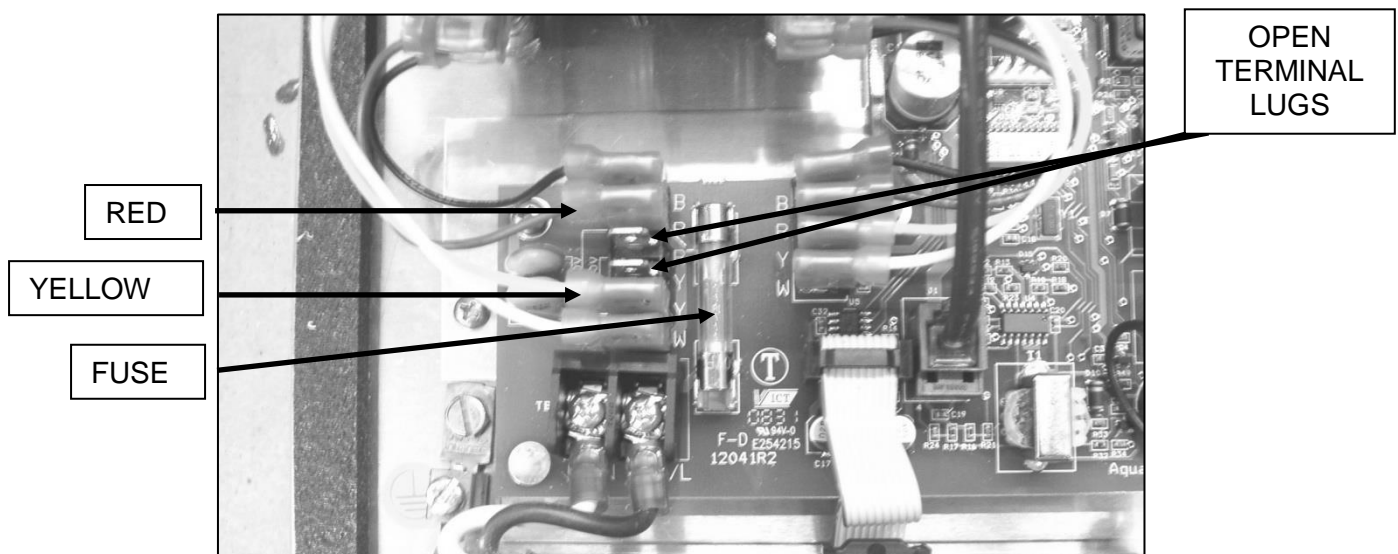
This voltage configuration can be changed in the field by a qualified electrician if required.

Refer to the wiring diagram located on the inside of the power center cover to reconfigure the wires on the terminal block if the unit AC input voltage is going to be changed from 230 Vac to 115 Vac, or see below.

Configuring the Power Supply for 110V-120V Operation:

- 1) Remove the cover by loosening the (4) recessed Phillips screws in the front corners of the cover.
- 2) Move the RED wire from the third terminal up to the second terminal
- 3) Move the YELLOW wire from the fourth terminal down to the fifth terminal.
- 4) Install the fuse labeled FUSE: 2A 250V 3AG SLO BLO into the fuse clip on the power supply board as shown in the photo below.

*Note: If a 110V cord is needed, you can order the AutoPilot Power Cord Kit #STK0196. You may also obtain a 16 AWG 2 conductor w/ground power cord, suitable for outdoor applications, from your local hardware or electrical supply store.



8.6.2 AC Input Voltage



WARNING: Failure to heed the following may result in injury or death.

The Digital Nano/Nano+ control center supply circuit must be protected by a ground-fault circuit-interrupter (GFCI).



CAUTION: Failure to heed the following may result in equipment damage.

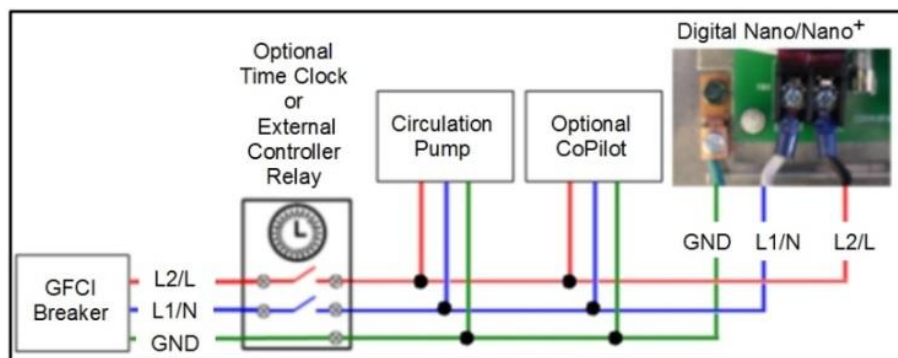
The AC input cannot be provided by an ORP Controller.

The Digital Nano/Nano+ control center is typically provided input power either directly from a GFCI breaker or from a timer or controller. Determine which is best for your application. Although not required, ideally the pump and Digital Nano/Nano+ are controlled by the same timer.

Connecting to an External Timer or Controller

- 1) Measure and cut ½" (13 mm) nonmetallic flexible conduit to reach from the power source to the Digital Nano/Nano+.
- 2) Feed the wires from Digital Nano/Nano+ through the conduit.
- 3) At time clock or external controller relay, connect AC power wiring to the LOAD SIDE or the same location as the circulation pump wires (pump connected to circuit breaker, time clock or electronic controller).
- 4) Connect the ground wire to the ground of the power source.

Figure 12



8.6.3 Low Voltage Wiring



WARNING: Failure to heed the following may result in permanent injury or death.

ELECTRICAL SHOCK HAZARD – Turn off the electrical power to unit before servicing.

Connecting the Cell Cable

- 1) The cell cable connector is keyed and must be aligned to connect properly. Line up the cell cord and plug into the cell cord connector located on the bottom right of the Digital Nano/Nano+ base plate.
- 2) The other end of the cell cable is connected to two (2) of the cells electrical terminals. A red weather plug is placed in the unused contact hole.

Connecting the Tri-sensor Cable

- 1) The Tri-sensor cable is 12' long (3.6 m) and connects the Tri-sensor Assembly to the Digital Nano/Nano+. Connect the white 6-pin connector to the mating receptacle located on the base of the Digital Nano/Nano+.

Connecting the Retractable Cover Switch (Option only available with purchase of #863A Expansion Board)



CAUTION: Failure to heed the following may result in equipment damage.
 The cover switch input must connect to an isolated dry contact output from the retractable cover unit. Connection to an energized switch will damage the Digital Nano/Nano+.
 The contact may not be shared by any other device.

- 1) Installation will require:
 - a) Two conductor insulated cable 20 AWG, similar to Alpha Wire number 6642 (not supplied).
 - b) External dry contact switch (provided by installer or retractable cover controller manufacturer).
- 2) Remove the cover by loosening the (4) recessed Phillips screws in the front corners of the cover.
- 3) Carefully release the RJ11 modular plug at the cover end of the cable that attaches the 841-2C Display Board. See Figure 17 on page 33. Carefully set the cover aside.



Figure 13



WARNING: Failure to heed the following may result in injury or death.
RISK OF ELECTRICAL SHOCK - Disconnect all AC input power before you proceed with the next step.

- 4) Affix the (5) 4-40 x 1/4" standoffs to the (5) 4-40 Kept Nuts, provided with the STK0156 kit, in the pre-drilled holes at top of the chassis. Do not over tighten. See Figure 14.
- 5) Place the 863A Expansion Board onto the standoffs and secure with (5) 4-40 x 1/8" pan head screws. See Figure 15.
- 6) Attach the flat ribbon cables (provided in the STK0156 Kit) to the 863A Expansion Board in 2 places; JP1 on left and JP2 on right. Be sure that the red line is on left side of the ribbon. See Figure 16.
- 7) Attach the flat ribbon cable from position JP1 on the 863A board, to the H1 position on the power supply board. See Figure 16.
- 8) Attach the second flat ribbon cable from position JP2 on 863A board, to the H4 position located on the Interface Board. See Figure 16.
- 9) Locate the terminal on the power supply board that has 4 male connectors. Remove the existing black and white wires from these terminals **only**. They will be the top and bottom positions. See Figure 17.
- 10) Using power cable ECA0348 provided in the STK0156 Kit, attach the multi-stack connectors as shown in Figure 19 (top and bottom positions).
- 11) Reattach the black and white wires, removed in step 9, to the multi-stack male terminals. Connections will go to the upper and lower male terminals. See Figure 20.
- 12) Attach the remaining ends from ECA0348 to the power terminals on the left side of 863A board. Note Black wire on top and white on the bottom. See Figure 18.
- 13) Remove the knock out at the bottom of the Nano chassis and install the split gland provided in the STK0156 Kit. Keep the gland loosened for next step. See Figure 21.

Figure 14

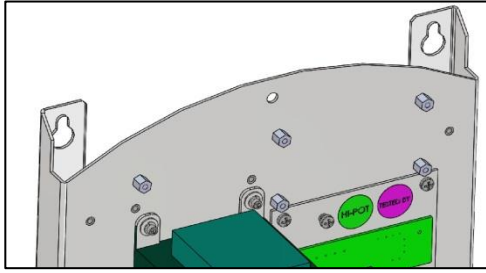


Figure 15

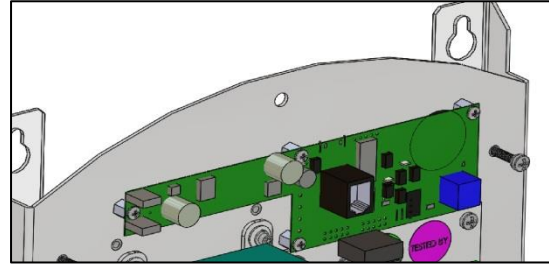
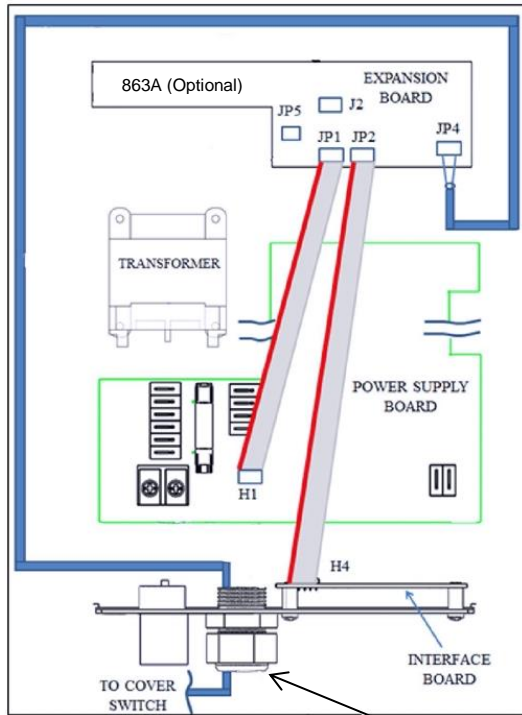
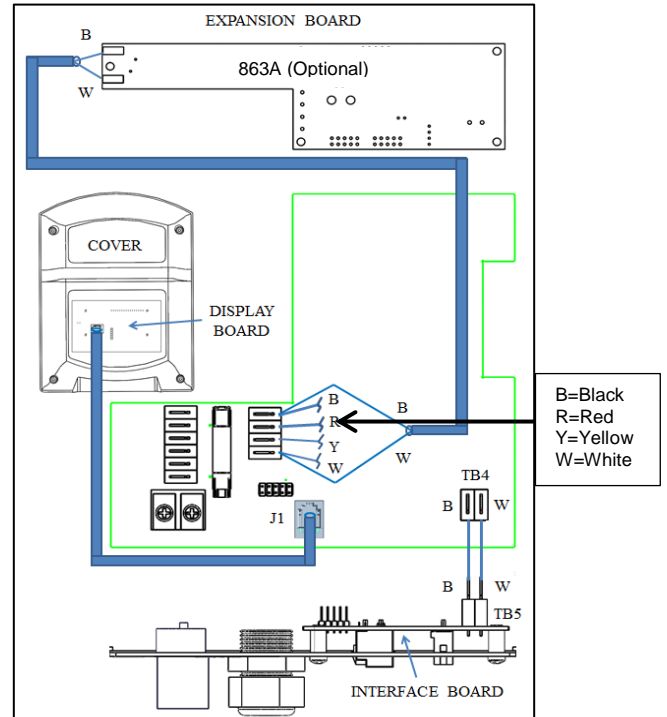


Figure 16



Split Gland

Figure 17



B=Black
R=Red
Y=Yellow
W=White

Figure 18

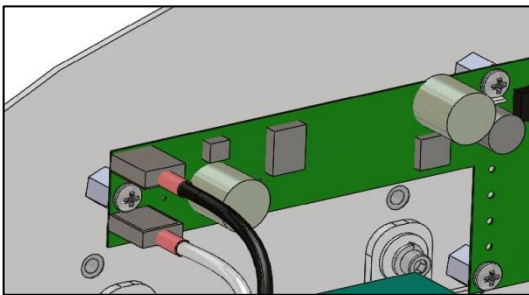


Figure 19

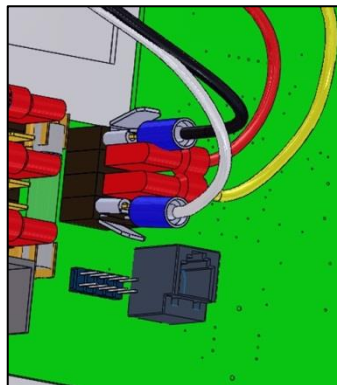
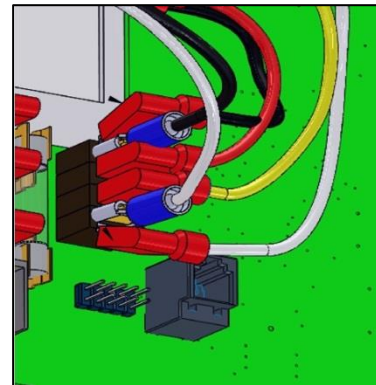


Figure 20



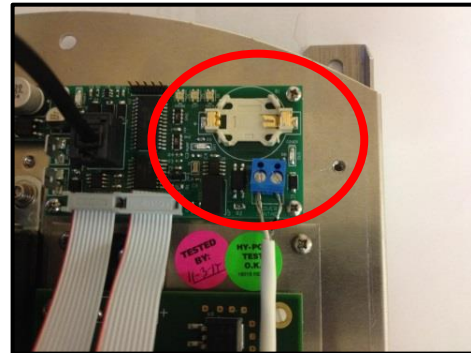
- 14) Thread the cover switch cable, provided by installer, through the gland as shown in Figure 21, below.
- 15) Connect the (2) conductors of the cable to the terminal labeled COVER CONTACT on the bottom right side of the 863A Expansion Board. See Figure 22.
- 16) Reattach the RJ11 modular cable at J2 on the display board, previously released in step 3, back to the J1 position on the main board. See Figure 17 on page 33.

 **CAUTION:** Do not connect the RJ11 cable to 863A Expansion Board.

Figure 21

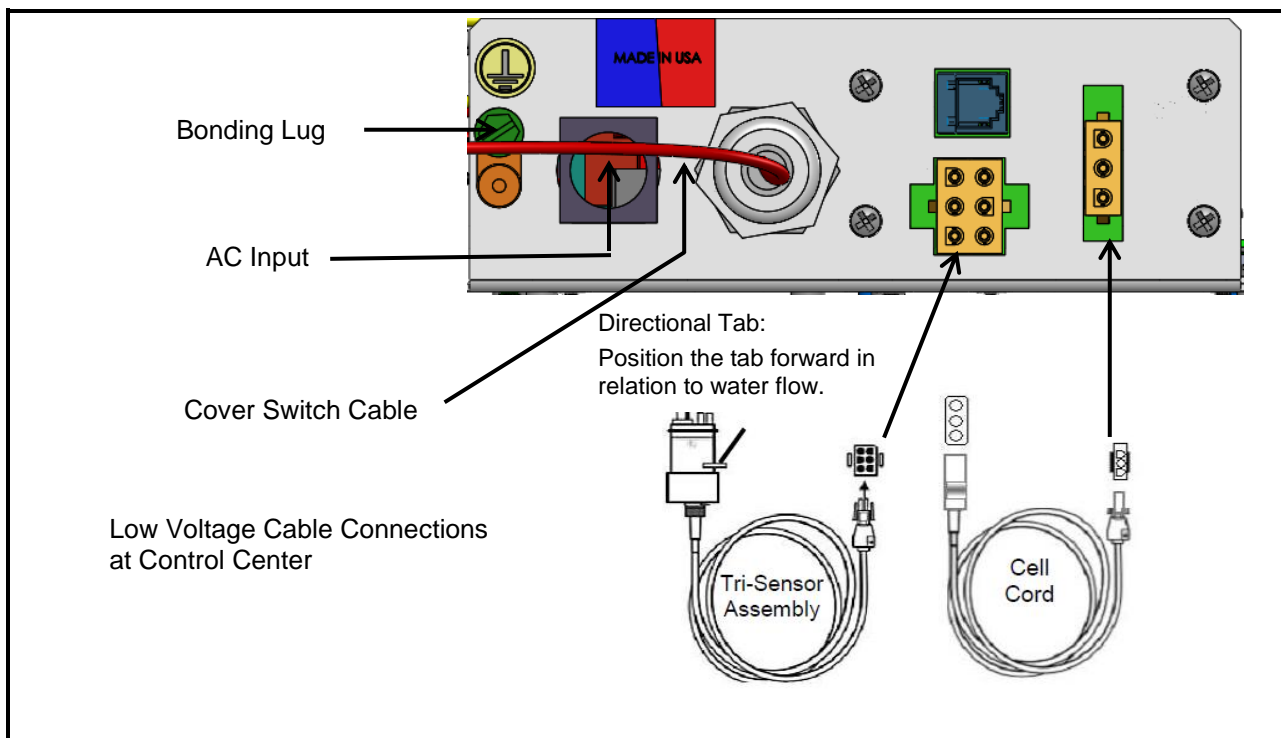


Figure 22



8.6.4 Bonding

The Digital Nano/Nano+ must also be connected to the pool/spa bonding system with an 8 AWG (6 AWG for Canada) wire. A bonding lug is provided at the bottom, exterior of the control center. See below.



8.7 PLUMBING THE SYSTEM

The Manifold Assembly has 2" PVC Slip Socket connections. Metric PVC adapters, 2" spigot x 63 mm socket, are provided with metric manifold models that have an "M" suffix, such as PPMxM. The manifold is plumbed into the pool return line after the heater and spa diverter valve, if applicable.

See Figure 10 and Figure 11 on page 27 for typical installations.

8.7.1 Plumbing the Manifold Assembly

Select the location for installing the manifold:

- It is recommended the manifold be planned prior to installation of the Digital Nano/Nano+. The Digital Nano/Nano+ must be installed close enough to the Manifold Assembly to allow the Tri-sensor and cell cables sufficient slack to enable component service and maintenance. The cables are 12' (3.6 m) long.
- The Bypass Manifold/Cell (model PPMxx) assembly must be installed in a vertical orientation as illustrated in the diagram on page 27. This orientation prevents hazardous gas buildup in the system, should the flow switch fail to detect insufficient flow.
- The direction of the water flow through the manifold must be as indicated for the system to operate properly.
- For a Pool/Spa combination, the manifold must be located as the last component in the pool return line to avoid over-sanitization of the spa.

Flow Rates 15 – 70 GPM (57 – 265 L/min)

- The manifold can be directly plumbed into the system (as shown in the diagrams on page 27).
- If the flow rate for the system is less than 15 gpm (57 L/min), a larger pump must be installed (or steps taken to improve flow rate).
- For a two-speed or a variable speed pump, ensure the pump can provide sufficient flow at the low speed.

Flow Rates Exceeding 70 gpm (265 L/min)

- A 5 lb. (35 kPa) bypass check valve must be plumbed in parallel with the manifold.
- Manifolds are to be installed in a vertical (upright) position **ONLY**.

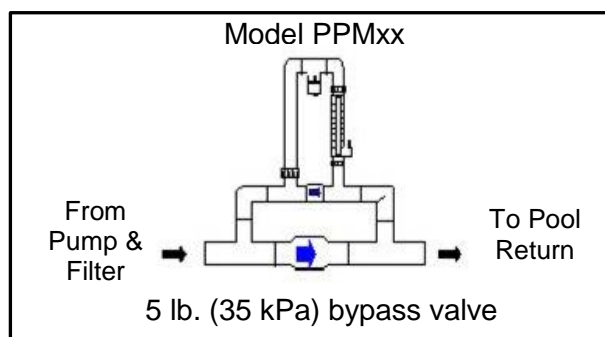


Figure 23

8.8 PREPARING THE POOL WATER

Installer please note - When properly sized to the site, the Digital Nano/Nano+ will meet the sanitizer “maintenance” requirements of the pool/spa. The Digital Nano/Nano+ is not designed to chlorine shock treat, or build up a chlorine residual, when starting with a zero or very low chlorine level.

Before starting the Digital Nano/Nano+, the water must be properly balanced, and the chlorine level must be adjusted to between 1 to 3 ppm (mg/L) free chlorine. More on adjusting water balance, and start-up chlorine levels, follows below.

8.8.1 Steps to Prepare Water

- 1) Calculate pool volume. See section 8.8.2.
- 2) Adjust water chemistry. Add chemicals to adjust pool or spa water chemistry parameters as indicated in the table in section 3.5, “Water Balance and Chemistry Recommendations” on page 7. The saturation index can be calculated using the information in section 10.2, “Using the Saturation Index” on page 51. If the index indicates that the pool water is corrosive or scaling then adjustments to the water chemistry should be made.
- 3) Add initial chlorine dosage. Use sufficient chlorine as obtained from pool supply center, to achieve 1-3 ppm (mg/L) free chlorine.
- 4) Add salt to water (test the water for salt level first). Adjust to 3,000 – 4,500 ppm (mg/L). See “Salt Addition Chart” on page 52.
- 5) Enter pool volume information into the Digital Nano/Nano+. See “Set Pool Volume” programming on page 23.

8.8.2 Calculating Pool Volume

To determine the approximate number of gallons or liters in a pool or spa:

- 1) Determine the surface area.
- 2) Multiply the surface area by the average depth and the constant conversion factor of 7.5 to convert cubic feet to gallons or 1,000 to convert from cubic meters to liters

Rectangle

- Area = Length x Width
- Gallons = area x average depth (ft³) x 7.5
- Liters = area x average depth (m³) x 1,000

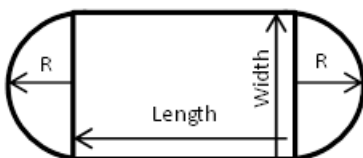
Circular

- Area = Radius x Radius x 3.14
- Gallons = area x average depth (ft³) x 7.5
- Liters = area x average depth(m³) x 1,000

To determine the approximate number of gallons or liters in a more complex shaped pool:

- 1) Divide the complex shape into several simple shapes.
- 2) Calculate each one separately, and then add back together.

Example: An oblong pool can be divided into two radius measurements and one rectangular shape. (R = Radius)



- Area = Radius x Radius x 3.14 + (Length x Width)
- Gallons = area x average depth (ft³) x 7.5
- Liters = area x average depth (m³) x 1,000

8.8.3 Adding Salt

Type of Salt to Add

It is important to use Sodium Chloride (NaCl) salt that is greater than 99% pure. Acceptable types of salt include granular food grade, pool salt, water softener pellets, or solar salt flakes; these are usually available in 25 to 60 lb. bags (11 to 27 kg) at local pool or building supply outlets. Pool salt or food grade granular salt will dissolve faster than pellets or flakes. Rock salt and Granular Salt with Iodine or Rust Preventatives should not be used, as these mixtures contain high levels of impurities and will cause staining. Granular salts containing anti-caking additives such as YPS (Yellow Prussiate of Soda) or sodium ferrocyanide are not recommended as they can cause a localized tint to the water or yellow staining of the pool/spa finish.

Amount of Salt Required

Test the water for current salt content first!

The ideal salt range is 3,000 – 4,500 ppm (mg/L). The minimum salt level is 2,500 ppm (mg/L). However, if so desired, the Digital Nano/Nano+ can operate with salt levels in excess of 35,000 ppm (mg/L). Salt levels above 6,000 ppm (mg/L) are not normally recommended, as corrosion issues may result. Salt levels below 2,400 ppm (mg/L) will reduce the efficiency of the Digital Nano/Nano+, and will result in low chlorine production. Extremely low salt levels below 1,900 ppm (mg/L) will activate the low salt safety cut off, and will halt chlorine production until salt is replenished to proper levels. Once the Digital Nano/Nano+ is programmed to the pool water volume, the controller will automatically indicate how much salt is required to attain ideal salt levels.

See the Salt Addition Chart and reference table, on page 52 for information on amount of salt to be added relative to the volume of water to be treated vs. existing salt level.

How to Add Salt to Pool



CAUTION: Failure to heed the following may result in equipment damage.

Do not use a pool cleaner or vacuum head with wheels, as wheels can leave track marks on newly-plastered pools. Do not allow Granular salt to pile up in one location, without brushing, as staining may occur.

The circulation pump should be run continuously until the salt has been fully dissolved – typically 24 hours. Add salt directly to pool (or spa, if a spa-only installation), and over the main drain (if main drain is present). If there is no main drain, a vacuum head may be used to encourage salt circulation. Distributing the salt by brushing is also helpful; brush the salt toward the main drain (if one is present). Set pump operation to normal run time after salt has fully dissolved into water.

If the salt level becomes undesirably high, the only way to remove excess salt is to partially drain the pool/spa and refill with fresh water.

8.9 PROGRAMMING AT INSTALLATION

The Digital Nano/Nano+ requires the pool volume be initially programmed into the installer menu. The Digital Nano/Nano+ will then indicate how many pounds (kgs) of salt to add should salt levels fall. The default pool size is 15,000 gallons (60,000 liters). The Salt Addition Chart on page 52 can also be used to calculate how much salt in pounds (kgs) should be added to reach the recommended level of 3,000-4,000 ppm (mg/L) salinity.

- 1) Enter the "Installer menu" and program "Set pool volume" for specific pool. See "Calculating Pool Volume" on page 36.
 - a) Press MENU
 - b) Press ∇ or Δ until "Installer menu" is displayed;
 - c) Press and hold SELECT for 13 seconds to enter the "Installer menu"
 - d) Press ∇ or Δ until "Set pool volume" is displayed; then press SELECT.
 - Factory setting is 15,000 gallons (60,000 liters).
 - The range is 500 to 125,000 gallons (2,000 to 500,000 liters).
 - e) Press ∇ or Δ until correct pool size is displayed; then press SELECT.
 - f) Press ∇ or Δ until "End menu mode" is displayed; then press SELECT.
- 2) Configure the following as needed. See Section 7.6, "Review of Installer, Owner, & Maintenance Menu Programming" on page 23 for more information.
 - a) "Select language" ("English language", "Idioma Español" "Langue Francaise" "Deutsche sprache", "Lingua Italiana" or "Cesky Jazyk")
 - b) "Select units" (gallons/liters, lb/kg, ppm/mg/L)
 - c) "Temperature units" (°F or °C)
 - d) "Audio alarm" (On or Off)
 - e) "Display temp" ("Hide temperature" or "Show temperature")
- 3) Press ∇ or Δ to adjust chlorine output to 50%.

8.10 LANGUAGE TRANSLATION MATRIX

English	Francais	Italiana	Español	Deutsche	Cesky
000 gallons	000 gallons	000 galloni	000 galones	000 Gallonen	000 Galon
000 liters	000 litres	000 litri	000 litros	000 Liter	000 Litr
1 minute	1 minute	1 minuto	1 minuto	1 Minute	1 minuta
12 hour clock	Horaire 12 heure	Orario 12h	Reloj 12 horas	Uhr 12 Std.	12 hodin
12/24 hour clock	Horaire 12/24	Orario 12/24h	Reloj 12/24	Uhr 12/24	12/24 hodin
24 hour clock	Horaire 24 heure	Orario 24 ore	Reloj 24 horas	Uhr 24 Std.	24 hodin
500 gallons	500 gallons	500 galloni	500 galones	500 Gallonen	500 Galon
Add salt	Ajout Sel	Poco sale	Adic.Sal	Salz zug.	Prid sul
Amp-Hours = zero	Heures-amp = 0	Amp-Ore = 0	Amp-hrs = 0	Amp-Std = 0	Amp-Hod.= 0
Amp-Hrs =	Hrs-amps =	Amp-Ore =	Amp-hrs =	Amp-Std =	Amp-Hod.=
Audio alarm	Alarme	Avviso	Alarma	Audio Alarm	Alarm
Bad temp sensor?	Sonde To defect?	Sen.temp.guasto?	SensorTempDefec?	Tempsens.Defekt?	Chyba tepl.Cidla
Boost	Choc	Urto	Super	Boost	Boost
Calibrate salt	Calibrer sel	Calibrazione sale	Calibrar sal	Salz kalibrieren	Kalibrace soli
Calibrate temp.	Calibrer temp.	Calibraz. temp.	Calibrar temp.	Temp kalibrieren	Kalibrace teplot
Cell =	Cell =	Cella =	Celda =	Zelle =	Clanku
Cell inspect due	Inspector cell	Controlli cella	Fecha inspc.Celd	Zelle unters.	ClankuInspekDue
Cell is cleaning	Cycle nettoyage	AutopuliziaCella	Limpieza celda	Reinigung Zelle	Cisteni clanku
Cell power =	Puissance cell=	Potenza =	Poder celda =	Leistung Zelle=	Uroven vystupu
Cell reversing	Cell s'inverse	Inversione cella	Invirtiendo cel.	Zelle Umkehrmod.	Zpatny chod
Celsius	Celsius	Celsius	Grados Celsius	Celsius	Celsius
Check flow	verifier débit	Controlla flusso	Revisar flujo	PrüfeDurchfluss!	Zkontr. prutok
Check/clean cell	Verif/Nett cell	Verifica cella	Revisar/Limp cel	Zelle prüfen	Inspekc clanku
Cooling	Refroidissement	Raffreddamento	Enfriando	Kühlend	Chlazení
Cover closed	Couverture fermé	Coperchio chiuso	Cubierta Cerrada	Abdeckung zu	Zakryty bazún
Cum.	Cum.	Cum.	Acum.	Kum.	Kum.
Day(s)	Jour(s)	Giorno(i)	Día(s)	Tag(e)	den/dny
Delay	Retard	Ritardo	Retardo	Vrz°grng	Zpozdeni
Disabled	Debrancher	Disattivo	Inhabilitar	kein	Vynout
Display temp	Afficher temp.	Display temp.	Mostrar temp	Display temp.	Zobrazení C
Display time	Afficher time	Display time	Mostrar hora	Display time	Zobrazení time
Enabled	Brancher	Attivo	Habilitar	bereit	Zapnout
End menu mode	Sortir mode menu	Esci menu	Salir menú	Menü Modus Ende	Vystup z menu
English language	Langue Francaise	Lingua Italiana	Idioma Español	Deutsche sprache	Cesky Jazyk
English units	Unites anglaises	Misure inglesi	Unidades Inglesas	Englische Masse	Angl. jednotky
Error purify off	Erreur CL2 off	Errore cloro off	Error purif. off	Fehler prod. aus	Vyroba OFF!
Error! Check	Erreur! Verifier	Errore! Verifica	Error! Verifique	Fehler! Prüfe	Error! kontrola
Exp Bd SW	Exp Bd SW	Exp Bd SW	Exp Bd SW	Exp Bd SW	Exp Bd SW
External	Exterieur	Esterno	Externo	Externer	Externi
Fahrenheit	Fahrenheit	Fahrenheit	Grads Fahrenheit	Fahrenheit	Fahrenheit
Flow at sensors	debit apres sond	FlussoAiSensori	flujo en sonda	DurchflussSonden	tok na senzory
Force reverse	Forcer inversion	Pulizia forzata	Forzar inversión	Umkehrmodus	Zpetny chod ruc.
g/L	g/L	g/L	g/L	g/L	g/L
Hide temperature	Masquer temp.	Nascondere temp.	Ocultar temp.	Temp ausblenden	Nezobrazit C
Hide time	Masquer time	Nascondere time	Ocultar hora	Time ausblenden	Nezobrazit time
High	Haut	Alto	alto	hoch	vysoky
High Speed	Grande vit.	Alta velocita	Alta velocidad	Schnell	vysoky rychl.

English	Francais	Italiana	Español	Deutsche	Cesky
hour on	HeureOn	ore sopra	Hora on	Zeitein	Cas On
Installer menu	Menu install.	MenuInstalazione	Menú instalación	Install. Menü	Instalacni menu
Low	Bas	Bas.	Bajo	ger.	Nizke
Low Amps: Cell?	Amps bas - cell?	Basso Amp-Cella?	Bajo Amperaje?	A.niedrig-Zelle?	Nizke amp.clanku
Low-speed	Basse vitesse	Bassa velocita	Velocidad baja	Low-speed	Nizka Rychl
Maintenance	Maintenance	Manutenzione	Mantenimiento	Wartung	a - Udržba
Maintenance menu	Menu maintenance	MenuManutenzione	Menú mantenimto.	Wartungsmenü	Menu udrzby
Metric units	Unites metriques	Misure metriche	Unidad Métricas	Metrisch	Metricke jedn
minutes	minutes	minuto	minutos	Minuten	minuty
mL/day	mL/jour	mL/giorno	mL/dia	mL/Tag	mL/den
Not supported	Pas installé	Non supportati	No soportado	Nicht verfügbar	Nefunkcni
Off	Off	Off	Off	aus	Off
off at	off at	Spento a	Apagado a	aus bei	Off v
On	On	On	On	AN	On
on at	on at	Acceso a	Encendido a	an bei	On v
Owner options	Options utilisat	Opzioni cliente	Opción usuario	Eigenes menü	Nast. majitele
Ozone	Ozone	Ozone	Ozono	Ozone	Ozone
Power level	Puissance	Potenza	Potencia	Stromstärke	Uroven vystupu
ppm	ppm	ppm	ppm	ppm	ppm
Press any key	Presser button	Premi TuttoTasto	Presione tecla	Beliebige Taste	zmackni klavesu
Prog-Delete	Prog-Effacer	Imposta Annulla	Prog-Borrar	Prog-Löschen	Prog-Smaz
Program deleted	Programme efface	Cancella program	Programa borrado	Progr. gelöscht	Program vymazat
Pump high at	Pompe haute a	Pompa alta a	Bomba alta a	Pumpe hoch bei	cerp. vysoko v
Pump low at	Pompe basse a	Pompa bassa a	Bomba baja a	Pumpe niedr. bei	cerp. nýzko v
Pump off	Pompe Off	Pompa Spenta	Bomba Off	Pumpe aus	cerp.vyp
Pump off at	Pompe off a	Pompa spenta a	Bomba off a	Pumpe aus bei	cerp.vyp v
Pump on at	Pompe on a	Pompa accesa a	Bomba on a	Pumpe an bei	cerpadlo on v
Purifier	Electro.	Cloro	Purific.	Chlorpr.	Vyroba
RC-28	RC-28	RC-28	RC-28	RC-28	RC-28
RC-35/22	RC-35/22	RC-35/22	RC-35/22	RC-35/22	RC-35/22
Remote operation	Tele Fonction	Operazione remot	Operación remota	Fernbed. Modus	Dalkovy provoz
Replace cell	Remplacer cell	Cambiare cella	Reemplazar celda	Zelle ersetzen	Vymena clanku
Reverse = 2 hrs	Inversion= 2 hrs	Inversione = 2 h	Inversión= 2 hrs	Umkehr = 2 Std.	Zpetny chod = 2h
Reverse = 4 hrs	Inversion= 4 hrs	Inversione = 4 h	Inversión= 4 hrs	Umkehr = 4 Std.	Zpetny chod = 4h
Reverse = 8 hrs	Inversion= 8 hrs	Inversione = 8 h	Inversión= 8 hrs	Umkehr = 8 Std.	Zpetny chod = 8h
Reverse = 16 hrs	Inversion=16 hrs	Inversione =16 h	Inversión=16 hrs	Umkehr = 16 Std.	Zpetny chod =16h
Salt =	Sel =	Sale =	Sal =	Salz =	Slanost
Salt adjust	Ajuster sel	Regola sale	Ajuste sal	Salz anpass.	Nast. soli
Select language	selection langue	Scegli lingua	Selección idioma	Sprache wählen	vyber jazyka
Select system	Choisir config	Scegli sistema	Selecc. equipo	Wählen System	vyber systemu
SELECT to clear	SELECT - effacer	SELECT - radura	SELECT borrar	SELECT f.Löschen	Zmackni SELECT!
Select units	Choix unites	Scegli misura	Selec. unidades	Masseinheit?	vyber jednotek
Set cell power	Regler puissance	Potenza cella	Ajustar Potencia	Leistung Zelle?	vykon clanku
Set cell type	Regler type cell	Scegli TypoCella	Ajuste tipo celd	Zellentyp einst.	Typ clanku
Set pool volume	Saisir volume	Volume piscina	Ajust.Vol.Piscin	Pool volumen?	velikost lazne
Set reverse time	Regler inversion	Tempo inversione	Ajust.Tiempo inv	Zeit Umkhr einst	Cas zpet. chodu
Set time of day	Regler heure	Giorno settimana	Ajustar hora	Zeit einstellen	Nastaveni casu
Set to	Regler	Metti a	Ajust. a	einst.	Nast.Na

English	Francais	Italiana	Español	Deutsche	Cesky
English	Francais	Italiana	Español	Deutsche	Cesky
Show temperature	Montrer temp.	Mostrare temp.	Ver temp.	Temp zeigen	Zobrazit C
Show time	Montrer time	Mostrare time	Ver hora	Time zeigen	Zobrazit time
Software	Logiciel	Software	Software	Software	Software
Start Pump	DemarrerPompe	Avvia pompa	Arrancar Bomba	Pumpe Start	Zap. cernadlo
SW_Version_2	SW_Version_2	SW_Version_2	SW_Version_2	SW_Version_2	SW_Version_2
Temp. adjust	Ajust temp	Regola temper	Ajuste temp	Temp. anpass.	Nast.Teploty
Temperature	Temperature	Temperatura	Temperatura	Temperatur	Teplota
Temperature unit	Unite de temp	Unità mis temper	Unid de temp.	Wähle Grad F/C	Teplotni jedn.
Test Pool Pilot	Test Pool Pilot	Test Pool Pilot	Test Pool Pilot	Test Pool Pilot	Test Pool Pilot
to	à	a	a	zu	a
to pick function	Choix fonction	Per Sel.Funzione	Escoger función	Funktion wählen	vybrat funkci
to stop pump	pour arret pompe	ferma pompa	Parar bomba	Pumpe stoppen	Vyp.cernadlo
Use ▽ Δ +SELECT	Util ▽Δ +SELECT	Usa ▽ Δ +SELECT	Use ▽ Δ +SELECT	wähle▽Δ +SELECT	vyber ťa + SELECT
Used	utilisé	Usato	Usado	Verwendet	Pridane
View setup	voir réglages	Vedi settaggi	Ver ajuste	Setup ansehen	Zobrazeni
Voltage low!	Basse tension!	Basso voltaggio!	Voltaje bajo!	Niederspannungs!	Nizke napeti
Warning!	Attention!	Attenzione!	Advertencia!	warnung!	Varovani!
welcome!	Bienvenue!	Benvenuti	Bienvenidos	willkommen!	Vítejte!

SECTION 9 - TROUBLESHOOTING

MESSAGE DISPLAYED	PROBLEM	TYPICAL SOLUTION
Cell inspect due	This is an advisory message. The unit will generate chlorine normally while this message is displayed.	The cell has been operating for a while. This is a reminder that now would be a good time to remove and inspect the cell and filter screen to see if they need cleaning. No problem has been detected. This is simply a time elapsed maintenance message. Press and hold SELECT to clear this message.
Cell is cleaning	This is an advisory message.	The cell is reversing polarity when this message is displayed. Normal production will resume shortly.
Purify off ## Day(s)	Chlorine generation is off and will start in ## days. This is an advisory message.	The Purify Off feature has been activated. See section 7.6.10 for more information or to inactivate this feature.
Error purify off Check flow	Chlorine generation has stopped due to insufficient water flow.	<ol style="list-style-type: none"> 1. Turn on the circulation pump. 2. Turn the control valves to the correct position to allow water flow through the manifold. 3. If installed, check suction type vacuum cleaner for blocked or restricted water flow. 4. Check and clean the skimmer basket. 5. Check and clean the pump basket. 6. Check and clean or backwash the main circulation filter. 7. Clean the manifold screen of trash or debris. For instructions to clean the screen, test the flow switch, clean the bypass valve (on a bypass manifold only), see Maintenance section 6.2.4 "Test Tri-sensor Flow Switch" on page 14 of the manual. 8. Verify that the Tri-sensor cable is plugged in. Plug it in, using care to orient it correctly before inserting it. See page 13. 9. Clean the cell if clogged with debris or calcium scale. See section 6.3 on page 15. 10. Check for air in the bypass manifold by loosening the top union on the cell to see if air or water comes out. If air comes out then there may be a vacuum side leak or the pump may be undersized. Check for leak at pump basket O-ring, leaking valve or fitting. 11. If the pump is a 2-speed pump, is it on low speed? The low speed may not create enough flow for the manifold. If using a variable speed pump, increase the RPM.
Error purify off Add salt xxx lb	Chlorine generation has stopped because the salt level is below 2,000 ppm (mg/L) (which is too low).	Add salt as indicated on the Digital Nano/Nano+ display to bring the salt level up to 3,000 ppm (mg/L).
Warning! Add salt xxx lb	The salt level is between 2,000-2,400 ppm (mg/L) (which is low).	Add salt as indicated on the Digital Nano/Nano+ display to bring the salt level up to 3,000 ppm (mg/L).
Error purify off Add salt xxx lb Warning! Add salt xxx lb	Added salt as indicated by the Digital Nano/Nano+, but salt level still shows low.	<ol style="list-style-type: none"> 1. The pool volume has not been set up in the Installer Menu and is higher than the factory default of 15,000 gallons (60,000 liters). 2. The salt sensor in the Tri-sensor may be dirty. 3. The Salt display may need to be calibrated. See "Calibrate Salt" on page 23

MESSAGE DISPLAYED	PROBLEM	TYPICAL SOLUTION
No Error Displays	Salt level on display does not match pool store or salt test strip.	<ol style="list-style-type: none"> The test may have been faulty or the salt strips may be old or damaged. Have salt level rechecked at local pool store. If the discrepancy is more than 400 ppm (mg/L), then calibrate salt. See "Calibrate Salt" on page 23 for more information.
Warning! Check/clean cell See additional troubleshooting on this error later in section.	Conductivity of the water is reduced; usually caused by low salt, cold water or a scaled cell or a combination thereof.	<ol style="list-style-type: none"> Check the salt level and adjust to between 3,000-4,500 ppm (mg/L) or verify salt calibration. For water temperatures below 65°F (18.3°C), increase salt to 3,500 – 4,500 ppm (mg/L). Remove and inspect the cell for white calcium scale. (See section 6.3, "Servicing the Cell" instructions on page 15 in the Maintenance section of manual.)
	The salt level is below 2,800 ppm (mg/L) & temperature below 70°F (21°C).	Increase salt level to 3,500 – 4,500 ppm (mg/L) or increase temperature on heater if applicable.
	The salt display differs from salt test.	Adjust salt display in the Salt Calibration mode. See "Calibrate Salt" on page 23 for more information.
	The cell is scaled.	<ol style="list-style-type: none"> Water Chemistry related problem (See Reference section of manual, Water Chemistry and Saturation Index topics). The Digital Nano/Nano+ may not be reversing polarity – contact your local AutoPilot Service Center. <ul style="list-style-type: none"> Adjust water chemistry or adjust Set Reverse time to a shorter cycle.
	If this is a new installation...	Verify the incoming voltage matches the voltage of the Digital Nano/Nano+. (See Specifications and Installation sections of manual.)
Warning! Low Amps: Cell? See additional troubleshooting on this error later in section.	Cell is completely clogged from calcium scale, may be depleted, the cell cord is loose or damaged.	<ol style="list-style-type: none"> Check cell for calcium scale buildup. Clean as needed. Check for visual wear on the edges of the terminal blades which may be an indication that cell is depleted. Replace if depleted. Check the cell cord for tight connections on the cell and on the power supply. Check the plug for burns. Tighten or replace as needed.
	The cell cord is disconnected.	Verify cell cables are inserted fully into the Digital Nano/Nano+ base cell connector.
	The cell is heavily scaled.	Remove and acid wash as described in the Maintenance section of manual.
	If this is a new installation...	Verify that the incoming voltage matches the voltage of the Digital Nano/Nano+. (See Specifications and Installation sections of manual.)

MESSAGE DISPLAYED	PROBLEM	TYPICAL SOLUTION
Warning! Low Amps: Cell?	Cell is not receiving the expected Amps.	<ol style="list-style-type: none"> Enter Test Pool Pilot mode through the menu. Write down the salt level, water temperature, and cell volts and amps. <ul style="list-style-type: none"> If the volts are 24-26, then the problem is usually caused by low salt, improperly connected, disconnected or loose cell cord, water less than 65°F (18.3°C), a scaled cell, or cell near end of life. Correct as appropriate. If the volts are less than 20, then contact AquaCal AutoPilot, Inc. for assistance. Installer: If the unit is configured for 230 Vac operation, then verify the input AC voltage is not 115 Vac. Supply correct voltages or reconfigure the unit as appropriate.
Warning! Check/clean cell		
Warning! Low cell volts	Cell may be shorted.	<ol style="list-style-type: none"> Check cell for calcium scale buildup. Clean as needed. Check cell for wire or other debris that is shorting the electrodes.
	Cell cord failure.	The cell cord has a short. Replace.
Warning! Bad temp sensor?	Temperature is out of range.	<ol style="list-style-type: none"> Check the Tri-sensor cable; make sure it is not disconnected or loose. Check the water temperature. <ul style="list-style-type: none"> If confirmed temperature is OK, contact AquaCal AutoPilot, Inc. for assistance.
(All three of the following messages are being displayed.) Warning! Low Amps: Cell? Warning! Low cell volts Warning! No output	Digital Nano/Nano+ control unit problem.	<ul style="list-style-type: none"> All 3 messages must be displayed for this to be a control unit problem. Contact AquaCal AutoPilot, Inc. for service. If all 3 messages are not being displayed then refer to the specific individual fault message above.

MESSAGE DISPLAYED	PROBLEM	TYPICAL SOLUTION
Normal display	<p>There are no warning messages on the display but the chlorine level is too low. Water quality looks dirty or cloudy.</p>	<ol style="list-style-type: none"> 1. The chlorine setting has been fine, but a temporary boost of chlorine is needed to adjust for rain or a temporary bather increase. Press the BOOST button to temporarily elevate the chlorine production level to 100% for 24 hrs. The chlorine output will revert to the original setting after 24 hrs. 2. The chlorine setting has been fine, but a temporary (or longer) Super Boost of chlorine is needed to adjust for heavier rain or bather increase. Press and hold the BOOST button for 8 seconds to temporarily elevate the chlorine production level to 100% for 72 hrs. The chlorine output will revert to the original setting after 72 hrs. 3. Check pool chemistry parameters. (See “Water Balance and Chemistry Recommendations” on page 7 in the “Owner’s Quick Start” section of manual.) The Cyanuric acid level may be low and the chlorine is being consumed quickly by the UV from the sun. 4. The chlorine output needs to be increased. <ul style="list-style-type: none"> • Use the UP arrow key to increase the chlorine output setting. • Increase the pump run time so the Digital Nano/Nano+ is generating chlorine for a longer period of time. 5. Consult your local pool service professional and test for high phosphate levels. Use a product such as Lo-Chlor[®] Lo-Phos[®] to reduce phosphates. 6. If the water temperature is 55°F (10°C) or colder, the Pool Pilot[®] has automatically turned the Chlorine output down to 1% to avoid over-chlorination. Bacteria and algae activity is greatly reduced at these temperatures, so, this should not be a problem. Hand dose additional chlorine if necessary. 7. Obtain an independent salt reading to check the Pool Pilot[®] reading. Add salt, if needed, and re-calibrate the Pool Pilot[®] salt display. 8. Check the “Max temp” in the Setup Menu. If higher than the Shutoff temp., unit may be going into a cooling mode. Shade, or relocate unit to an area less affected by direct sunlight or other sources of heat external to the unit. 9. Possible Digital Nano/Nano+ fault. <ul style="list-style-type: none"> • Press BOOST. Wait 10 seconds for the unit to start the Boost cycle. • Press MENU. Select “Test Pool Pilot”; record the Volts and Amps when displayed. If the Volts are less than 4.0 and the Amps are less than 1.5, contact the factory for assistance.
	<p>There are no warning messages on the display. The chlorine level is too low but the pool water looks fine.</p>	<ol style="list-style-type: none"> 1. The test kit reagents or strips may be old or have been exposed to sunlight. Replace the kit or reagents and retest. 2. There is too much chlorine in the pool. The chlorine is bleaching the test kit reagents. <ul style="list-style-type: none"> • Dilute the water sample with distilled water and retest. Lower the chlorine output setting with the DOWN arrow button if the chlorine level is too high.

MESSAGE DISPLAYED	PROBLEM	TYPICAL SOLUTION
Normal Display (Continued)	Cover is closed. "Cover c losed" is not displayed. Chlorine production too high.	1. Confirm the installed Digital Nano/Nano+ model has the Pool Cover Detection feature. If not, manually reduce chlorine level when cover is closed. (The cover detection option is only available on some models. See Specifications in section 4.1 on page 8.)
	Cover is open. "Cover c losed" is displayed.	2. Check external cover position switch for proper operation. 3. Check cable/connections from the cover position switch to the Digital Nano/Nano+.
Temperature display shown or not shown	Temperature is not shown on normal display.	Normal operation if "Display temp." has been set to "Hide temperature" See section 7.6.7. "Display Temperature" on page 24 for instructions on how to change. Note: Temperature will always be visible in the "Test Pool Pilot" menu.
	Does not match other pool temperature displays.	1. Normal – This temperature may not match other pool devices due to the sensor location (ie: may be after heater). Disable "Display temp". See section 7.6.7. on page 24. 2. The temperature display can be disabled in the "Installer menu". 3. The temperature may be adjusted to match an external thermometer. See "Calibrate Temperature" on page 23.
Chlorine display	Chlorine locked at 1%.	If the water temperature is 55°F (10°C) or colder the Pool Pilot® has automatically turned the Chlorine output down to 1% to avoid over-chlorination. Bacteria and algae growth is greatly reduced at this temperature, so this should not be a problem.
	Cannot adjust chlorine production above 20% and "Cover c losed" is displayed.	1. Normal operation if your pool cover is closed. The Digital Nano/Nano+ will not allow the chlorine production to go above 20%. This is to avoid over chlorination. 2. If cover is open, then check the external dry contact cover position switch & cable for proper operation.
	Chlorine % fluctuates from adjusted value.	The AutoPilot® unit has a patented process for automatically increasing and reducing the chlorine output as the temperature of the water fluctuates. It is normal for the % output to increase as the water temperature increases, and to decrease as the water temperature decreases.
Blank display	The Pool Pilot® Display is blank.	1. If the display is in bright sunlight, then shade the display to read. 2. Verify external time clock has not turned off power to Digital Nano/Nano+. (Temporarily override the time clock, if desired, to check the Digital Nano/Nano+.) 3. Verify local shut off switch and/or main circuit breaker for Digital Nano/Nano+ is turned on. 4. If power is provided to unit by an external control device, verify power is provided to and from the device. 5. Fuse may be blown. See "Fuse Location and Ratings" on page 12 in Maintenance section for instructions.

MESSAGE DISPLAYED	PROBLEM	TYPICAL SOLUTION
Cooling	Unit is not generating Chlorine.	<p>Internal temperature of unit has exceeded "Shutoff temp", viewable in Setup Menu. Will turn off chlorine generation for five (5) minutes or until temperature decreases.</p> <ol style="list-style-type: none"><li data-bbox="906 323 1498 380">1. If this is not causing a chlorine shortage, let the unit automatically cool and resume normal operation.<li data-bbox="906 386 1498 443">2. Move Digital Nano/Nano+ to a shaded area if too hot.

SECTION 10 - REFERENCE

10.1 BASIC WATER CHEMISTRY

The Digital Nano/Nano+ is designed to produce chlorine on a daily basis. To monitor the system's efficiency, the water chemistry ranges, and schedule of periodic checks should be followed. See "Water Balance and Chemistry Recommendations" on page 7 for chemistry levels.



CAUTION: Failure to heed the following may result in equipment damage.

Excessively high chlorine levels can cause premature cell failure and corrosion damage to pool fixtures and equipment.

Always follow the instructions on the manufacturer's label whenever handling or using chemicals.

CHEMICAL	IDEAL TEST SCHEDULE	EFFECT OF LOW / HIGH LEVELS	CORRECTIVE ACTIONS
Free Chlorine	Weekly	<u>Low free chlorine:</u> Not enough residual chlorine to safely sanitize pool water.	<u>Low free chlorine:</u> Check for combined chlorine level and shock as necessary. Increase chlorine output to maintain a 1-3 ppm (mg/L) residual reading.
		<u>High free chlorine:</u> Corrosive to metallic fixtures in pool water. Can bleach swimwear and hair.	<u>High free chlorine:</u> Decrease chlorine output. Let chlorine dissipate normally until 1-3 ppm (mg/L) is achieved. In extreme cases, pool water can be diluted with fresh water or a chlorine neutralizer added. (Diluting will reduce salt and CYA. Check and adjust as needed.)
pH	Weekly	<u>Low pH:</u> (acidic) Equipment corrosion, eye/skin irritation, plaster etching, rapid chlorine consumption	<u>Low pH:</u> Add sodium carbonate or soda ash
		<u>High pH:</u> (basic) Scale formation, cloudy water, eye/skin irritation, poor chlorine effectiveness	<u>High pH:</u> Add sulfuric acid, muriatic acid or sodium bisulfate.
Total Alkalinity	Monthly	<u>Low TA:</u> Eye irritation, pH "bounce", stained/etched plaster and metal corrosion.	<u>Low TA:</u> Add sodium bicarbonate.
		<u>High TA:</u> Constant acid demand, difficulty in maintaining pH, and contributes to scale formation or cloudy water conditions.	<u>High TA:</u> Add sulfuric acid, muriatic acid often or sodium bisulfate, a little at a time (may take a week or more to lower the TA).

CHEMICAL	IDEAL TEST SCHEDULE	EFFECT OF LOW / HIGH LEVELS	CORRECTIVE ACTIONS
Calcium Hardness	Monthly	<u>Low CH</u> : Etching of plaster, equipment corrosion	<u>Low CH</u> : Add calcium chloride flakes.
		<u>High CH</u> : Scale formation, cloudy water. Rapid buildup of scale may exceed the system's self-cleaning capability and require manual cleaning of the cell.	<u>High CH</u> : Partially drain and refill pool with fresh water to dilute. (Diluting will reduce salt and CYA. Check and adjust as needed.)
Cyanuric Acid (CYA or Stabilizer)	Monthly	<u>Low CYA</u> : Destruction of chlorine by the UV rays from the sun.	<u>Low CYA</u> : Add Cyanuric acid (1 lb.(0.45 kg) per 5,000 gallons (18,930 liters) increases CYA 25 ppm (mg/L))
		<u>High CYA</u> : Requires more chlorine to maintain proper sanitizer levels. Note: CYA not needed for indoor pools or bromine pools. CYA can be reduced to 30 - 50 ppm (mg/L) for colder climate regions.	<u>High CYA</u> : Partially drain and refill pool with fresh water to dilute. (Diluting will reduce salt. Check and adjust as needed.)
Saturation Index	Monthly	<u>+ 0.3</u> : Water is scale forming. Calcium carbonate is falling out of solution. This rapid buildup of scale may exceed the system's self-cleaning capability and require manual cleaning of the cell.	<u>Balance water</u> as close to equilibrium of 0 as possible. See "Basic Water Chemistry" on page 51 for more information.
		<u>- 0.3</u> : Water is corrosive. Water will take away other material it comes in contact with to form a natural balance. These materials can be metallic fixtures, swimwear, etc. Results can also include cloudy water, eye/skin irritation, and poor chlorine effectiveness.	<u>Balance water</u> as close to equilibrium of 0 as possible. See "Using the Saturation Index" on page 51 for more information.
Salt	Monthly	<u>Low Salt</u> : Below 2,400 ppm (mg/L) causes premature cell failure and reduces chlorine production	<u>Low Salt</u> : Add salt according to digital display on Pool Pilot® unit or salt chart.
		<u>High Salt</u> : Above 6,000 ppm (mg/L) can cause corrosion of metallic fixtures and will taste salty. Note: Digital Nano/Nano+ can safely operate with salt levels up to 35,000 ppm (mg/L).	<u>High Salt</u> : If undesirably high, partially drain and refill the pool with fresh water. (Diluting will reduce CYA. Check and adjust as needed.)

Table 7

10.1.1 **Chlorine**

The desirable form of chlorine is called Free Chlorine. This form of chlorine is responsible for the actual sanitation activity in pools and spas. Free chlorine is highly reactive and, once added to pool/spa water, has a tendency to combine with organic matter in the pool/spa. It quickly attacks pathogens as well as other bather wastes. When chlorine combines, it chemically changes. The chlorine binds to organic matter and is referred to as Combined Chlorine. Combined Chlorine is responsible for eye burn and skin irritations. Total Chlorine is the sum of Free Chlorine and Combined Chlorine. If a strong chlorine odor is noted, it is due to an excess of Combined Chlorine. It is important to test Total Chlorine as well as Free Chlorine. If there is a difference greater than 0.2 ppm (mg/L), a shock treatment should be initiated.

During peak chlorine demand (summer months, rainy season or heavy bather usage) it may be necessary to increase your chlorine output by increasing your output setting. Conversely, during low chlorine demand, you can decrease your output to a lower setting. For extremely heavy chlorine demand or to boost your chlorine residual levels quickly, you can supplement with any type of chlorine or non-chlorine shock containing potassium monopersulfate. *Note: During cold-water conditions (below 60°F/15.6°C) chlorine demand is reduced significantly. For colder climate regions with sustained low temperatures, contact your local pool professional for proper pool winterizing instructions.*

10.1.2 **pH**

pH is a term used to refer to the degree of activity of an acid or base in the water. A low pH, acidic or corrosive water contributes to eye and skin irritation as well as damage to pool equipment. A high pH will result in scaling, cloudy water and ineffective sanitation. Improper pH also contributes to the strong smell, red eyes and dry itchy skin conditions usually associated with “too much chlorine”.

10.1.3 **Total Alkalinity**

Total Alkalinity refers to the ability of the pool water to resist a change in pH. It helps manage or control the pH in the pool. The desired range is 80 to 100 ppm (mg/L). Low alkalinity is aggressive or corrosive and causes the pH readings to fluctuate (pH bounce). High alkalinity may cause cloudy water and scale forming conditions. Your Digital Nano/Nano+ does not affect Total Alkalinity. Factors changing this measure are ancillary chemicals added to the pool and “out of balance” make-up water.

10.1.4 **Calcium Hardness**

Calcium Hardness is a measure of calcium content in the water. If the calcium content is too high, calcium can drop out of solution; forming scale on equipment. A low level will cause the water to become corrosive as the water tries to naturally form equilibrium. This means the water will “leach” minerals from everything it meets. Damage to equipment and unpleasant swimming conditions result. Your Digital Nano/Nano+ does not change Calcium Hardness. Factors changing this measure are ancillary chemicals added to the pool and “out of balance” make-up water.

10.1.5 **Cyanuric Acid**

Cyanuric Acid acts as water “Stabilizer” or “Conditioner”. This chemical goes by either trade name and allows your chlorine residual to last longer by protecting it from the UV rays of the sun. With low Cyanuric acid, chlorine can be used up just as quickly as it is generated. Check local commercial codes for maximum acceptable Cyanuric acid levels in commercial projects. *Note: For indoor pools, it is not necessary to maintain a stabilizer level to protect the chlorine from the UV rays. However, it is recommended to maintain a minimal 15 ppm (mg/L) to protect metallic fixtures from possible corrosion.*

10.2 USING THE SATURATION INDEX

This index is used by pool professionals to ensure that your total water chemistry does not fall into a corrosive or scaling condition. Either condition can cause premature damage to the cell, any of your other equipment, as well as your cementitious finish.

The Saturation Index is composed of the following factors:

- pH as tested
- Plus the Temperature factor
- Plus the Calcium Hardness factor
- Plus the Alkalinity factor
- Minus the Total Dissolved Solids factor (in this case the bulk of the dissolved solids are salt)

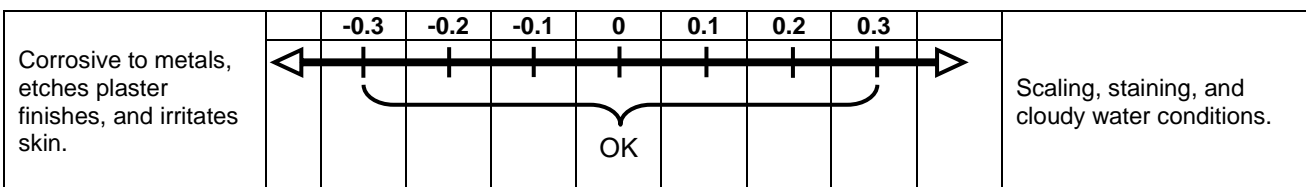
This is expressed in the formula $SI = pH + TF + CF + AF - TDSF$ and uses the following charts:

TEMPERATURE		TF	CALCIUM HARDNESS	CF	TOTAL ALKALINITY	AF	SALT LEVEL	TDSF
60°F	15.6°C	0.4	150 ppm (mg/L)	1.8	075 ppm (mg/L)	1.9	0000 - 1000 ppm (mg/L)	12.1
66°F	18.9°C	0.5	200 ppm (mg/L)	1.9	100 ppm (mg/L)	2.0	1001 - 2000 ppm (mg/L)	12.2
76°F	24.4°C	0.6	250 ppm (mg/L)	2.0	125 ppm (mg/L)	2.1	2001 - 3000 ppm (mg/L)	12.3
84°F	28.9°C	0.7	300 ppm (mg/L)	2.1	150 ppm (mg/L)	2.2	3001 - 4000 ppm (mg/L)	12.4
94°F	34.4°C	0.8	400 ppm (mg/L)	2.2	200 ppm (mg/L)	2.3	4001 - 5000 ppm (mg/L)	12.5
103°F	39.4°C	0.9	600 ppm (mg/L)	2.4	250 ppm (mg/L)	2.4	5001 - 6000 ppm (mg/L)	12.6

Table 8

Example:

WATER TEST RESULTS	FACTORS	WATER SATURATION
pH = 7.8	pH = 7.8	SI = 0.8 Water is scale forming and needs to be balanced
Temperature is 84°F	TF = 0.7	
Calcium Hardness is 600 ppm (mg/L)	CF = 2.4	
Total Alkalinity is 200 ppm (mg/L)	AF = 2.3	
Salt is 3500 ppm (mg/L)	TDSF = 12.4	



If adjustments need to be made to balance the water, the recommended sequence is as follows:

- 1) Test and adjust Total Alkalinity. This may reduce pH so wait at least 8 hours before proceeding.
- 2) Test again and adjust pH, then
- 3) Adjust Calcium Hardness.

10.3 SALT ADDITION CHART

The following salt charts are included for reference only; once programmed to the correct water volume, the controller will automatically indicate how much salt is required to achieve optimum water salinity.

The salt in the pool is constantly recycled during normal operation. Loss of salt during a swimming season should be minimal. Filter backwashing, draining due to rain water overflow, splashing, bathing suit drag out, and leaks are typical ways salt is lost. Salt does not leave the pool when water evaporates.

- 1) Determine pool/spa volume in Gallons or Liters.
- 2) Find current salt level in the pool. Many pools will already have a significant salt residual, so always test water before adding salt. (This can be obtained from the control display or by testing water.)
- 3) Using Table 9, find the current salt level in the left column.
- 4) Determine and locate the pool/spa volume in the top column.
- 5) Locate the intersection of the row and column to find the amount of salt needed to bring the pool to the ideal level.
- 6) For volumes other than what is shown, use combinations of various columns.

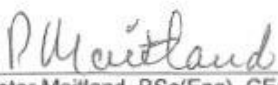
Example:

For an 11,000 gallon (41.640 Liter) pool with a salt level of 500 ppm (mg/L), the column value for 1,000 gallons (3.786 Liter) is added to the column value for 10,000 gallons (37.854 Liter), which gives a total of 230 pounds (104.33 kg) of salt needed to bring your pool salt level up to the ideal level of 3,000 – 4,500 ppm (mg/L).

Table 9

Current level of salt ppm (mg/L)	Pool/Spa Volume in gallons (Liters)									
	1,000 (3,786)	2,000 (7,572)	5,000 (18,930)	10,000 (37,860)	15,000 (56,790)	20,000 (75,720)	25,000 (94,650)	30,000 (113,580)	35,000 (132,510)	40,000 (151,440)
Pounds (kilograms) of salt needed to attain 3000 ppm (mg/L)										
0	25 (11)	50 (23)	125 (57)	250 (114)	376 (170)	501 (227)	626 (284)	751 (341)	876 (398)	1,002 (454)
250	23 (10)	46 (21)	115 (52)	230 (104)	344 (156)	459 (208)	574 (260)	689 (312)	803 (364)	918 (416)
500	21 (9)	42 (19)	104 (47)	209 (95)	313 (142)	417 (189)	522 (237)	626 (284)	730 (331)	835 (379)
750	19 (9)	38 (17)	94 (43)	188 (85)	282 (128)	376 (170)	470 (213)	563 (256)	657 (298)	751 (341)
1,000	17 (8)	33 (15)	83 (38)	167 (76)	250 (114)	334 (151)	417 (189)	501 (227)	584 (265)	668 (303)
1,250	15 (7)	29 (13)	73 (33)	146 (66)	219 (99)	292 (133)	365 (166)	438 (199)	511 (232)	584 (265)
1,500	13 (6)	25 (11)	63 (28)	125 (57)	188 (85)	250 (114)	313 (142)	376 (170)	438 (199)	501 (227)
1,750	10 (5)	21 (9)	52 (24)	104 (47)	157 (71)	209 (95)	261 (118)	313 (142)	365 (166)	417 (189)
2,000	8 (4)	17 (8)	42 (19)	83 (38)	125 (57)	167 (76)	209 (95)	250 (114)	292 (133)	334 (151)
2,250	6 (3)	13 (6)	31 (14)	63 (28)	94 (43)	125 (57)	157 (71)	188 (85)	219 (99)	250 (114)
2,500	4 (2)	8 (4)	21 (9)	42 (19)	63 (28)	83 (38)	104 (47)	125 (57)	146 (66)	167 (76)
Ideal 3,000 – 4,500										

10.4 DECLARATION OF CONFORMITY

Declaration of Conformity	
(according to ISO/IEC Guide 22 and EN 45014)	
Manufacturer's Name:	Aquacal Autopilot Inc.
Manufacturer's Address:	2737 24 th Street North, St. Petersburg, Florida USA 33713.
<i>declares that the product:</i>	
Product Name:	Pool Pilot Nano
Model Number:	75041.
to which this declaration relates, meets the essential health and safety requirements and is in conformity with the relevant EU directives listed below:	
EU EMC Directive 89/392/EEC EU Low Voltage Directive 73/23/EEC	
using the relevant sections of the following EU standards and other normative documents:	
EMC:	EN55014-1:2000 + A1 + A2:2002 EN55014-2:1997 + A1:2001 EN61000-3-2:2006 EN61000-3-3:1995 + A2:2005
Safety:	EN 60335-1:2002 + A11.2004 + A1.2004 IEC 60335-1:2002 + A1.2004
Fort Lauderdale, Florida USA. March 10th 2010. (Place and date of issue)	 Peter Maitland, BSc(Eng), CEng.

10.5 FCC COMPLIANCE

NOTE: This equipment has been tested and found to comply with the limits for a Class B digital device, pursuant to part 15 of the FCC Rules. These limits are designed to provide reasonable protection against harmful interference in a residential installation. This equipment generates uses and can radiate radio frequency energy and, if not installed and used in accordance with the instructions, may cause harmful interference to radio communications. However, there is no guarantee that interference will not occur in a particular installation. If this equipment does cause harmful interference to radio or television reception, which can be determined by turning the equipment off and on, the user is encouraged to try to correct the interference by one or more of the following measures:

- Reorient or relocate the receiving antenna.
- Increase the separation between the equipment and receiver.
- Connect the equipment into an outlet on a circuit different from that to which the receiver is connected.
- Consult the dealer or an experienced radio TV technician for help.



www.aquacal.com



www.autopilot.com

AquaCal AutoPilot, Inc.
2737 24th Street North
St. Petersburg, Florida 33713
(727) 823-5642