

#87952 - 87950

# HYDROTOOLS™

## Swimline®

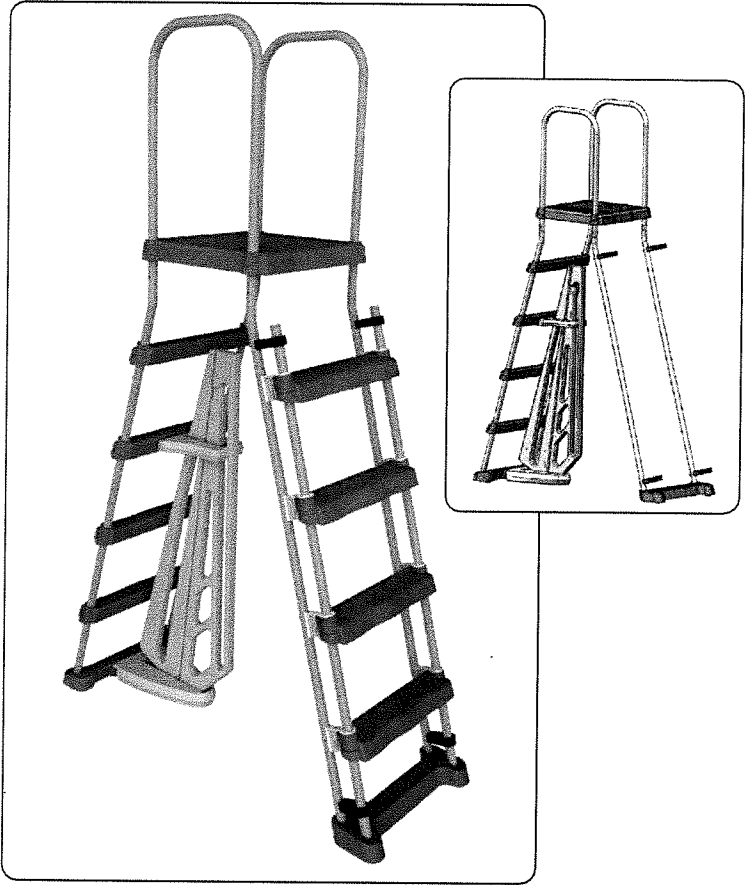

## ABOVE GROUND POOL LADDER

### ASSEMBLY & INSTALLATION INSTRUCTIONS

HydroTools by International Leisure Products, Inc.

191 Rodeo Drive, Edgewood, NY 11717 • Tel (631) 254-2155 • [www.swimline.com](http://www.swimline.com)

**Very important:**

- Do not use the ladder for any other purpose, it is only for use in above ground pools. •Maximum authorized mass: 275 lbs
- Put ladder in the safety position when not in use. • Check hardware for traces of rust) whenever possible.
- In winter, we recommend removing, cleaning, and drying the ladder to keep it in ideal condition.
- Failure to comply with maintenance rules may pose a serious risk to health, notably to children.
- Put ladder in the safety position when not in use.
- Do not attempt to swim around or behind the ladder. • Only one person at a time should climb up the ladder.
- Do not dive or jump from the ladder.
- Do not sit on the ladder. Do not allow children to use the ladder unless under supervision.
- Read these assembly instructions carefully. •Place the ladder on solid, level ground.
- Check the condition of the ladder components before assembly and during use.
- Apply the safety sticker on a step of the ladder so that it is clearly visible.
- Keep these instructions for information and future reference.

**This ladder is easy to install and can be assembled by one adult in more or less 1 HOUR. Only the following tools are needed: Flat screwdriver**

**Diagram 1:** Procedure for step & platform assembly & installation

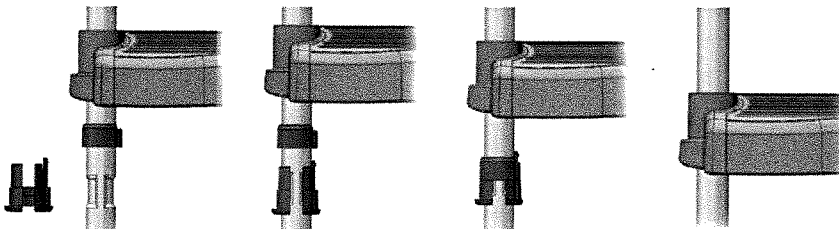

**Diagram 2:** Procedure for bushing installation

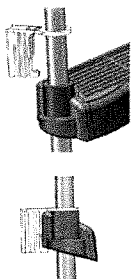

**Diagram 3:** Procedure for Tubing connection with Bolts, washers and nuts

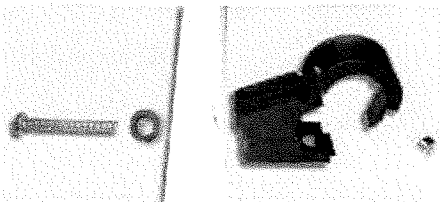
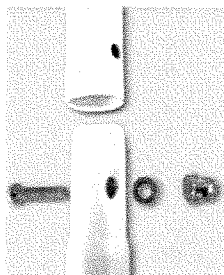
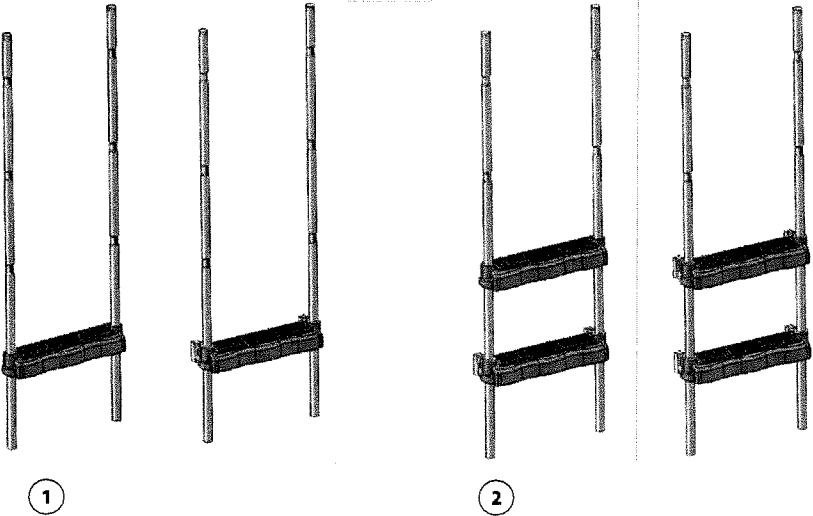

**Diagram 4:** Assembly of safety clips to handrail

**1. Assemble the inner steps**



**2. Assemble the outer, removable safety steps**



**Follow Diagram 1** See 1-4  
The side of the step with the white plug should face upward.

**2. Assemble the outer, removeable safety steps (continued)**

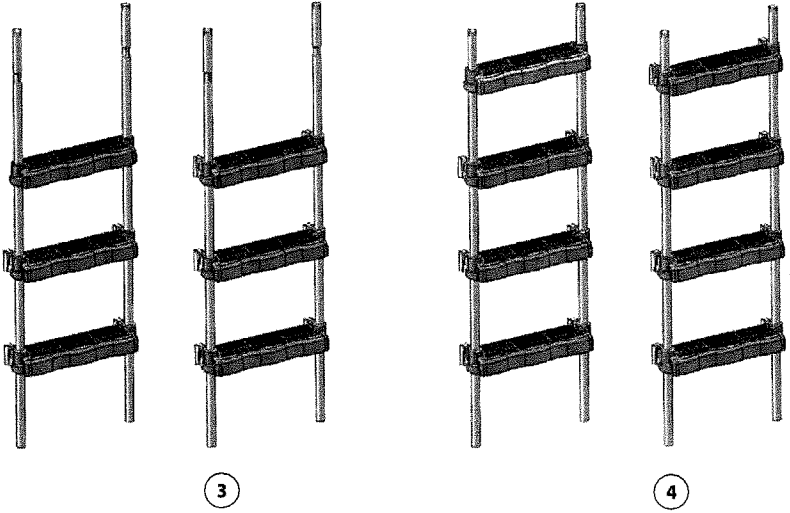

**3. Install the platform**

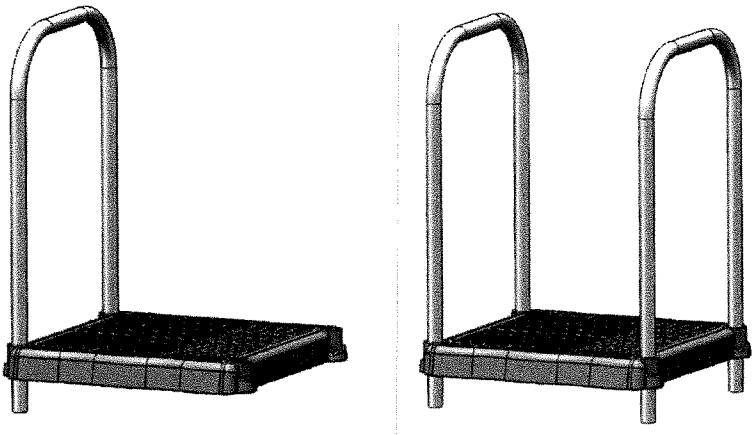

**Follow Diagram I** to install the platform in the connection bridges.

## 4. Ladder Installation

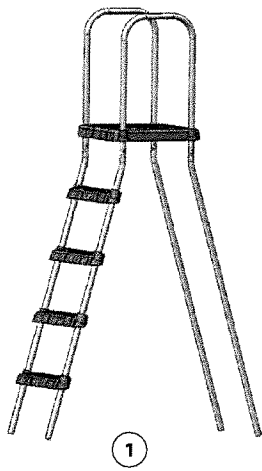

1. Lay the platform, inner ladder and outside handrail on ground. Follow the above picture to connect handrails. Follow Diagram III. Use Nuts & Bolts to assemble. The ladder will be in an "A" shape after connection of inner ladder; outside handrail and upper handrail.

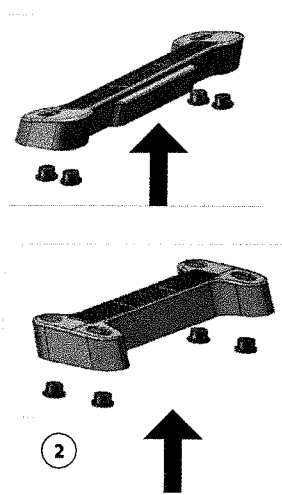

2. Insert 4 non-slip plugs from underneath the inner & outer base steps (see Illustration above)

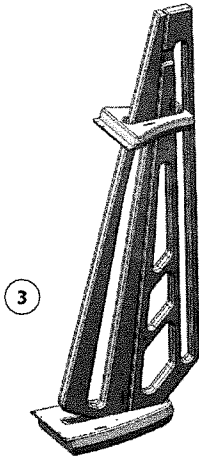

3. Install the barrier as illustrated.

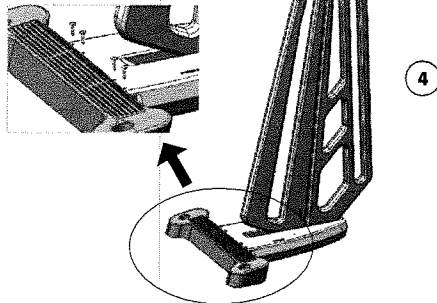

4. Connect inner bottom step and barrier with screws.

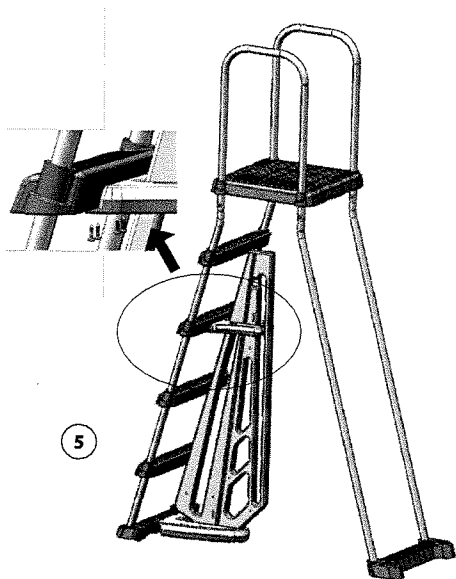

5

5. Connect inner fourth step and bar with screws see Figure 5. Stand the ladder up and install the base steps. (Note: Make sure you use the correct inner and outer base steps. Please refer to the above diagram.)

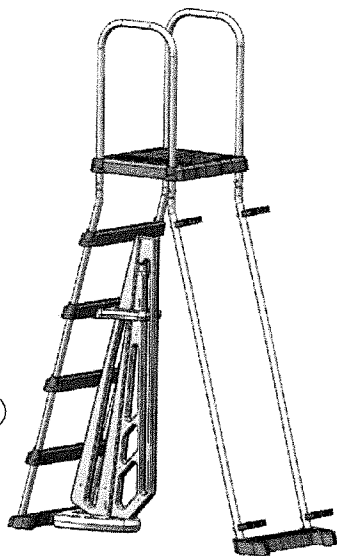

6

6. Following Diagram 4 Install the 4 safety clips on the outside ladder rail

**5. Install removable handrail**

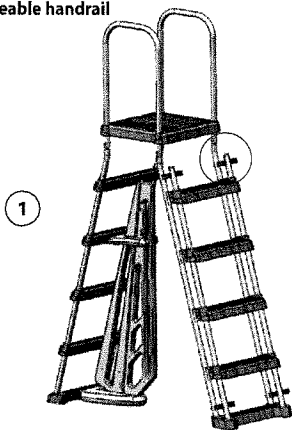

1

1. Insert the removable handrail into the holes in the bottom step, and lay the removable handrail against outside handrail.

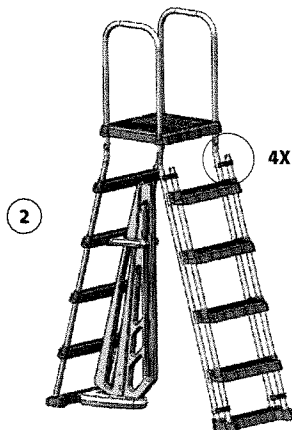

2

4X

2. Use 4 clips to affix the removable handrail to complete the assembly

# **HYDROTOOLS™** *Swimline®*

HydroTools by International Leisure Products, Inc.  
191 Rodeo Drive, Edgewood, NY 11717 • Tel (631) 254-2155 • [www.swimline.com](http://www.swimline.com)