

# poolfenceDIY

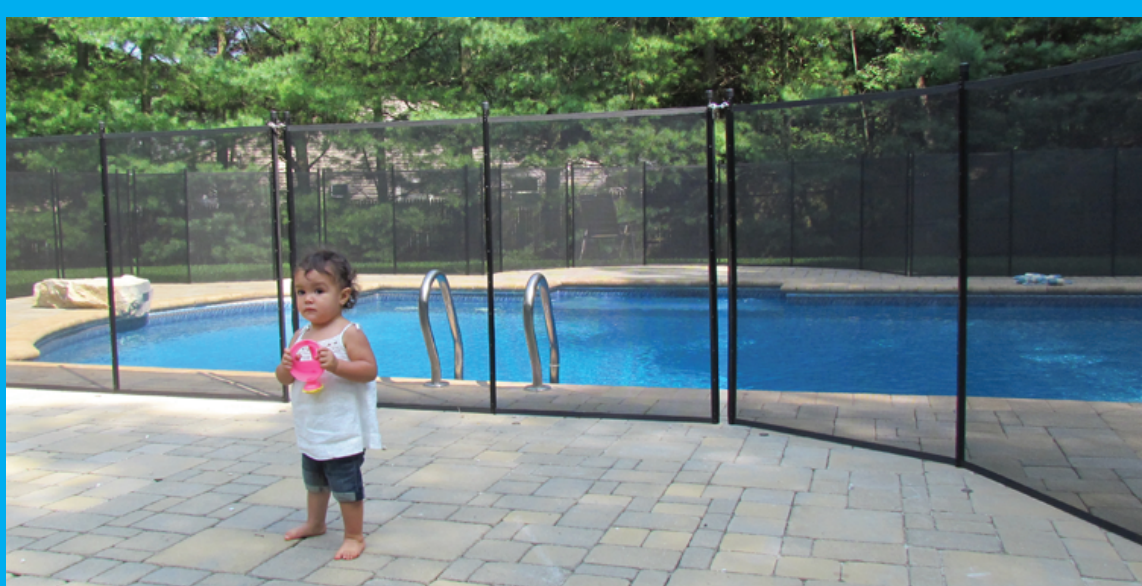
## Install Guide

### TOOLS REQUIRED

- |                             |                              |
|-----------------------------|------------------------------|
| 1. Rotary Hammer Drill      | 8. Scissors                  |
| 2. 5/8" Masonry Bit (14" +) | 9. Household Stapler         |
| 3. Extension Cord           | 10. #2 Square Head Screw Tip |
| 4. Tape Measure             | 11. 1/8" Metal Drill Bit     |
| 5. Hammer                   | 12. Cordless Screw Gun       |
| 6. Marker                   | 13. 1 - Template (Incl.)     |
| 7. Garden Hose              | 14. Chalk Line               |

**Each Fence Section Includes:** 1 Mark Out Template, 1 Latch, 5 Ground Sleeves, 5 Ground Caps

**NOTE:** Fence sections are 12' of pool fence mesh bordered on all four sides with 5 fence poles spaced every 36".



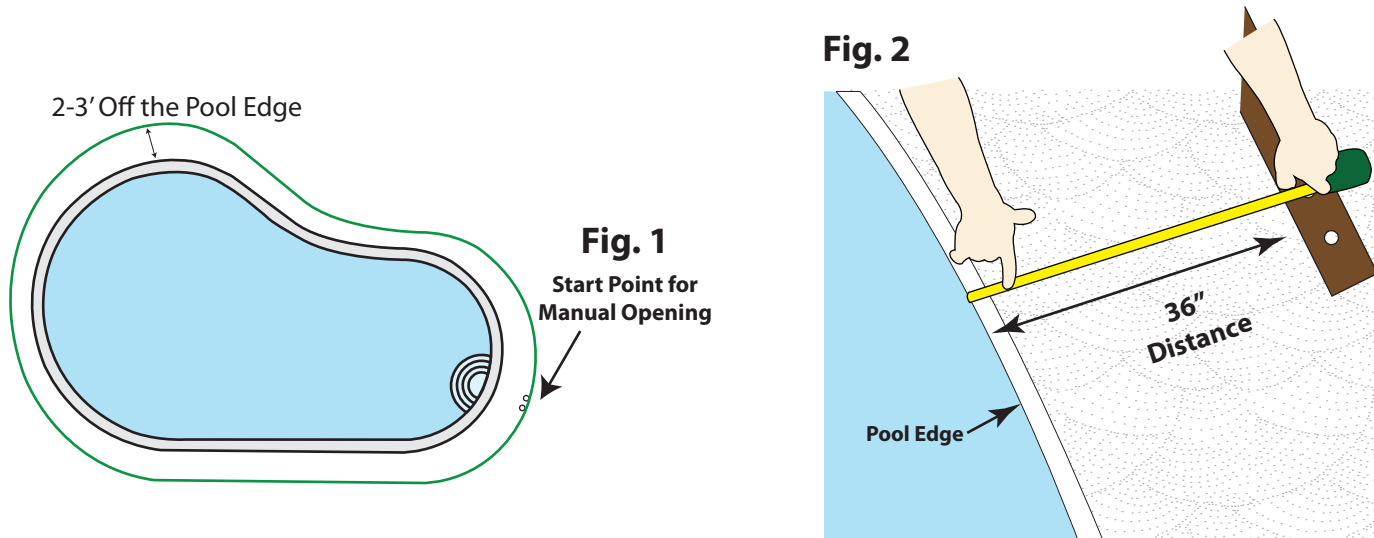
**REMEMBER:** Nothing replaces direct adult supervision. Never leave a child unattended.

**(Read Instructions Completely Before Beginning)**

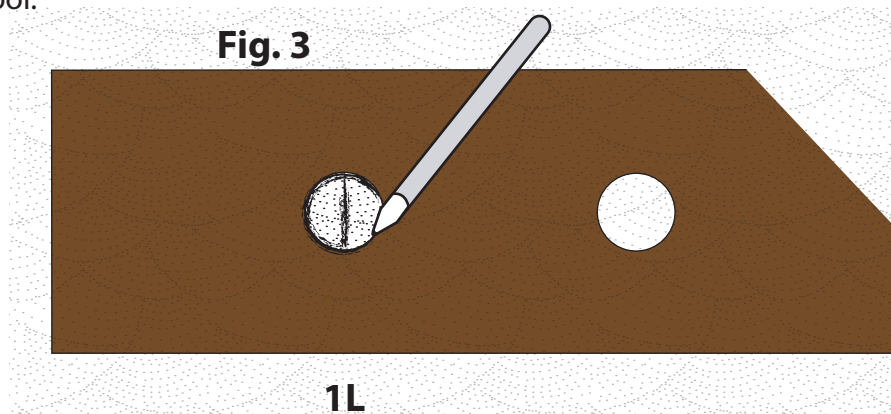
## Step 1: Layout & Mark-Out

**\*\*If using a self-closing gate, skip this step and refer to the instructions included in the gate box.**

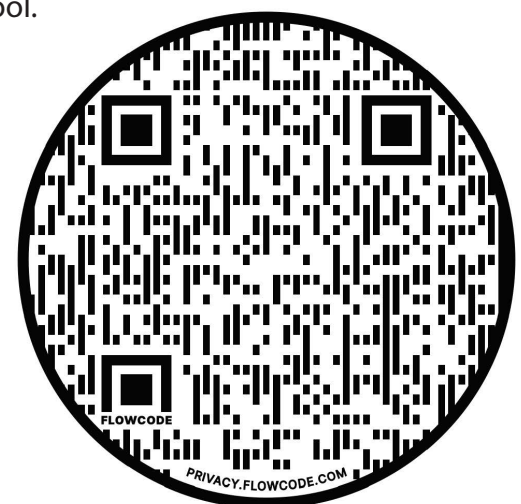
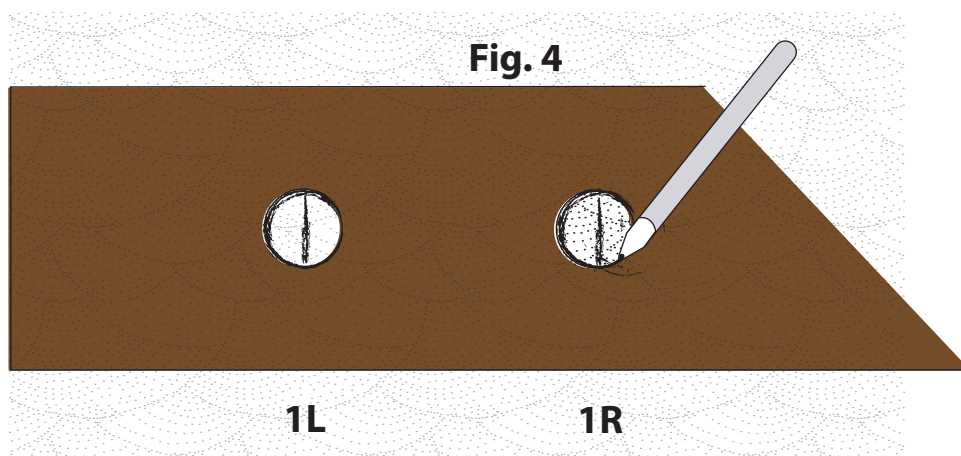
- **Layout:** The fence should be a minimum 2' off the pool edge. See **Fig. 1 & Fig 2**



- **Start Point:** Is the manual opening to enter the pool area. See **Fig. 1** Use the double hole on the section template provided and mark your first hole 1L **Fig. 3**. 1L is for the 1st pole of the full section going to the left side of the pool.

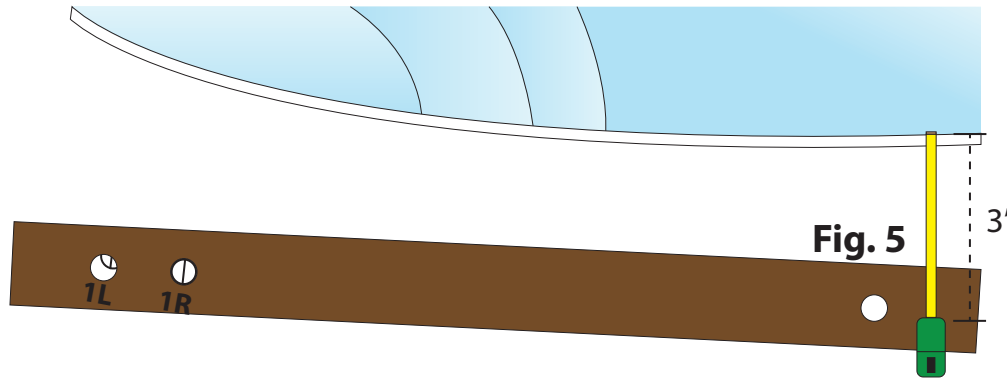


- Now, place the template over the mark 1L that you just marked and mark your next hole, 1R **Fig. 4**. 1R is for the 1st pole of the full section going to the right side of the pool.

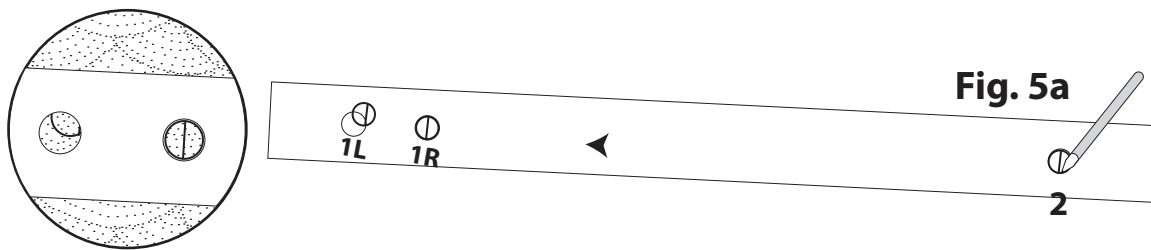


**Mark-Out:**

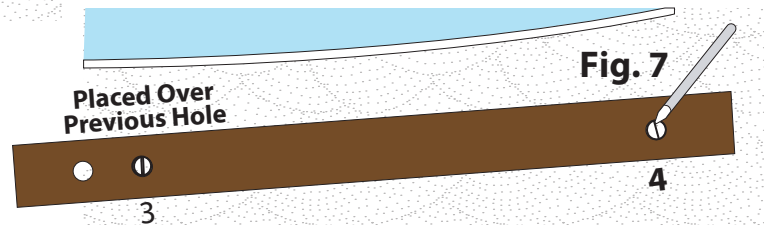
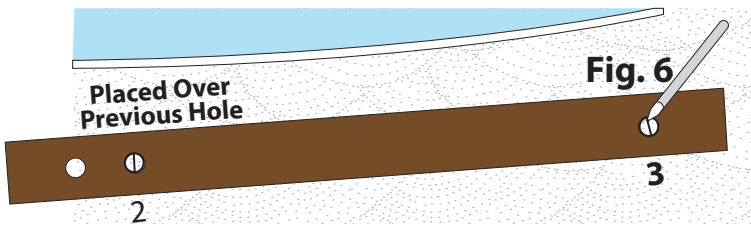
- Once both holes of the start point are marked, (1L & 1R) place the template provided over 1R **Fig. 5**.



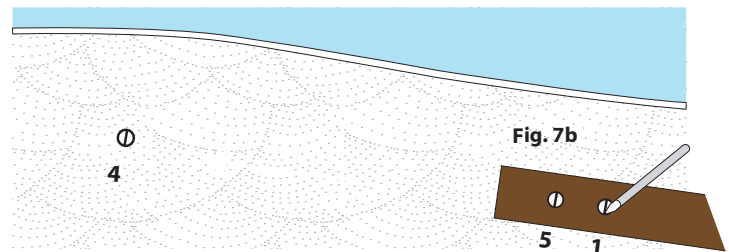
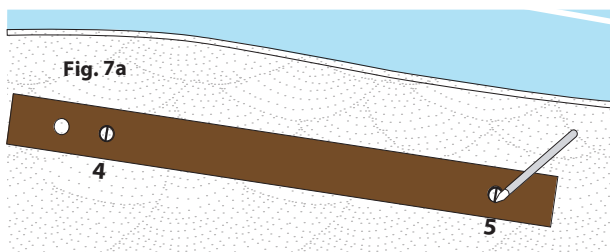
- Then place the template over 1R and mark your second hole for that section (**Fig. 5a**).



- Now repeat until the 5th pole of the section **Fig. 6-7a**



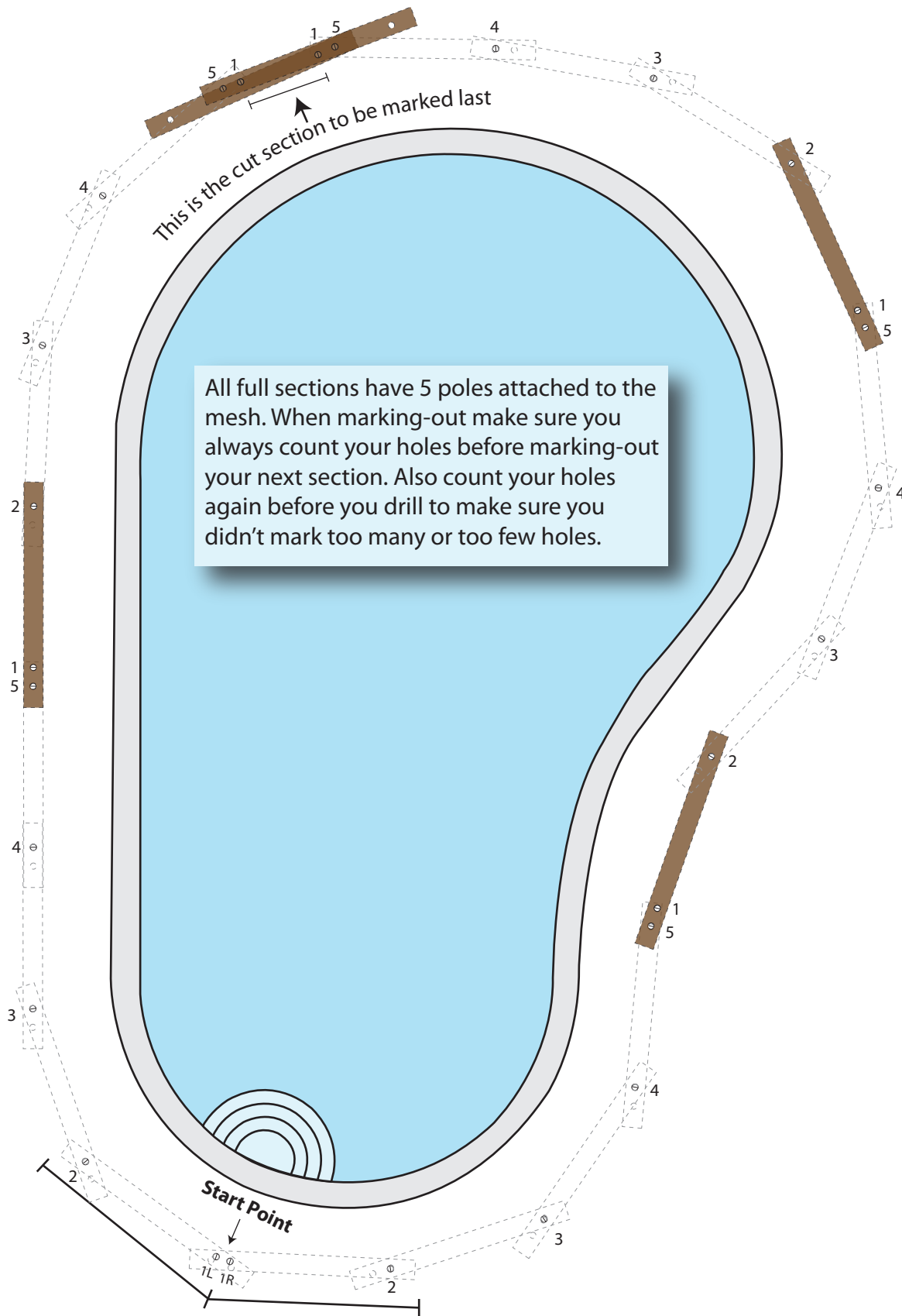
- Mark your last hole for that section, (hole 5) **Fig. 7a**.



- Then use the double hole on the template and align it over the 5th hole you marked **Fig. 7b** and mark the first hole of the next connecting section to the right, (hole 1). Repeat these steps on both sides of the pool until you reach the section that will be the cut section. For additional information call **561-316-6418**.

**\*\* See Fig. 8 on the next page for the full lay out example.**

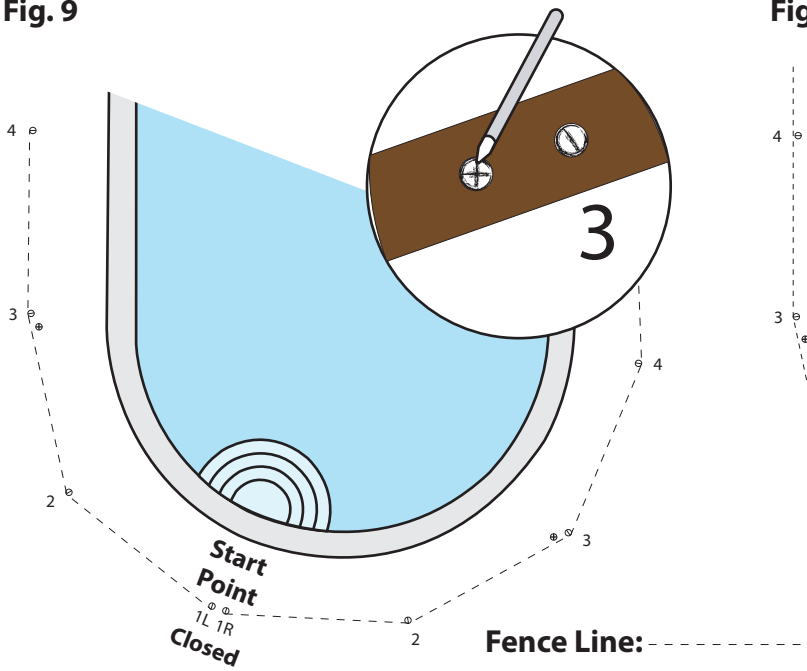
**Fig. 8**



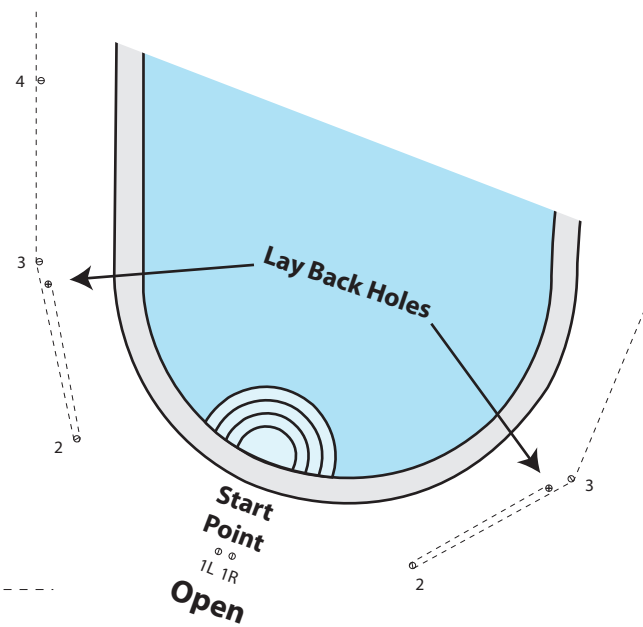
- **Custom Cut:** Is when the last piece is less than the 36" template. Marking your custom cut is just like marking out a full 3 foot panel only the last panel is usually shorter than 3 feet. This is the custom cut you will make later. This section is the last one marked out, usually in the back of the pool, where you will not notice it. The last piece will most likely have fewer poles in it. This example depicts a two pole cut. For additional information call **561-316-6418**.

- **Lay Back Holes:** are needed for the manual opening and are used to place the end poles of the section into when using the pool. See **Fig. 9 & 10**

**Fig. 9**

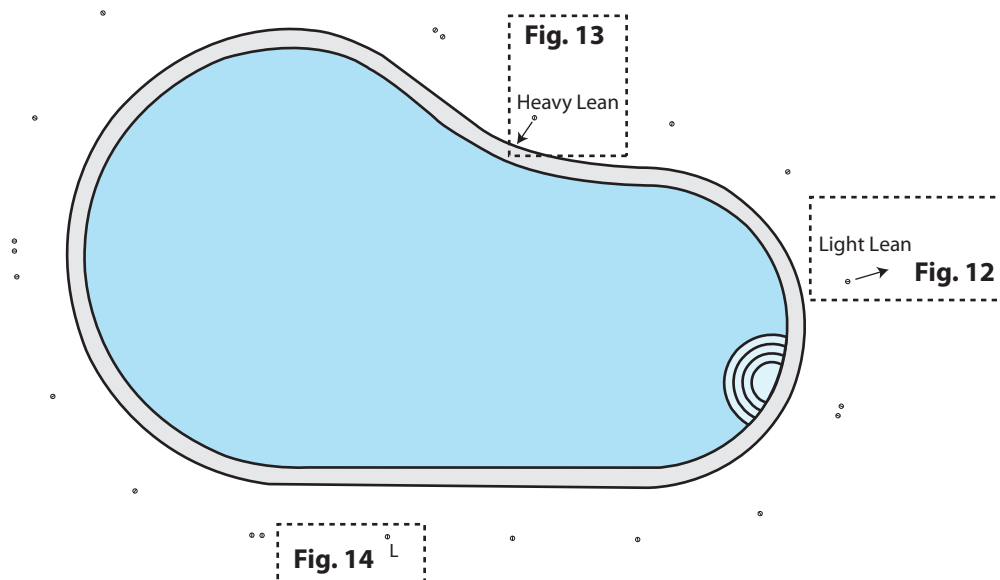


**Fig. 10**



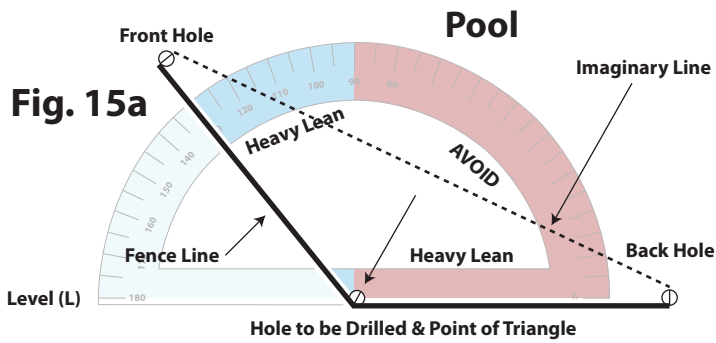
## Step 2: Understanding How to Drill

- **Angle & Level Holes:** Before drilling you need to survey all the holes and mark the direction in which the holes will be drilled, should it be a Light Lean Angle, Heavy Lean Angle or a Level Hole? Should the pole lean toward the pool or away from the pool or be level? See diagram below. Mark an arrow on the deck surface to avoid making a mistake. Angles are needed to ensure proper tension and aesthetics. **Fig. 12** shows a Light Lean away from the pool. **Fig. 13** shows a Heavy Lean toward the pool. Level holes are drilled perpendicular to the deck surface or no lean at all. See **Fig. 14** For additional information call **561-316-6418**.



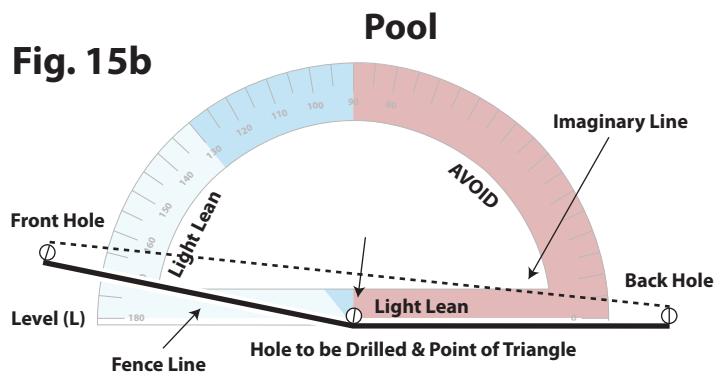
\* See next page for further explanation.

● Understand the Angle to be Drilled: See Fig. 15a-17



**PRO NOTES:** Any hole to be drilled will have a hole in front of it and one in the back of it as shown in Fig. 15a. If the hole to be drilled is in the heavy lean range, it will require a Heavy Lean. If the hole to be drilled is in the light lean range, it will require a Light Lean. See Fig. 15b. For additional information call 561-316-6418.

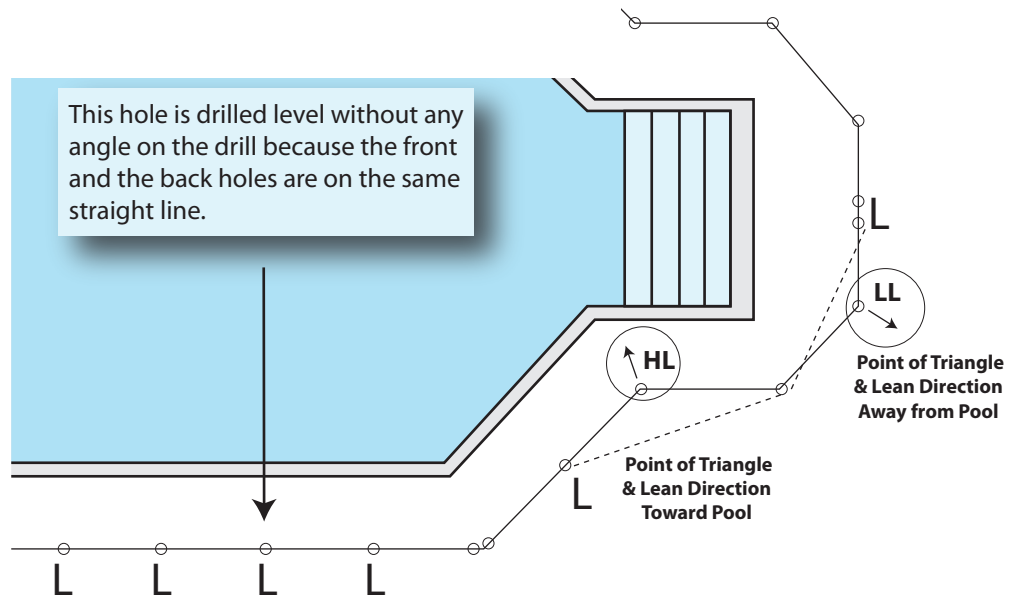
**Imaginary Line:**-----



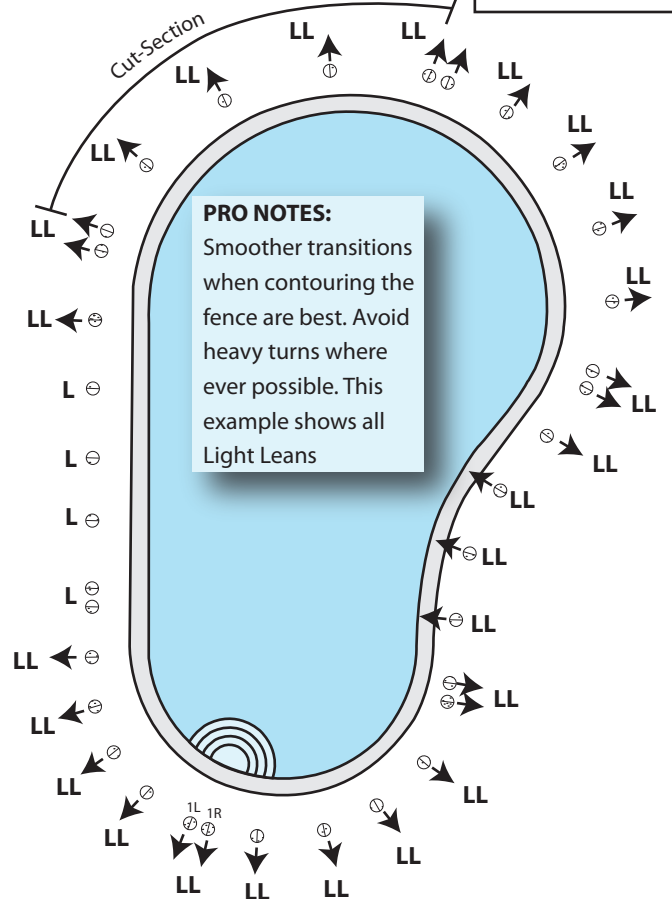
**Fig. 17**

**PRO NOTES:** When determining the lean of a hole, simply stand over the hole you are about to drill, then look at the hole in front of you and the hole behind you. If you connected all three holes with imaginary lines it would make a triangle. The point of the triangle indicates the direction of lean. The further away from the imaginary line the more of a lean. If it doesn't make a triangle then it is level.

**Imaginary Line:**-----  
**Fence Line:**\_\_\_\_\_

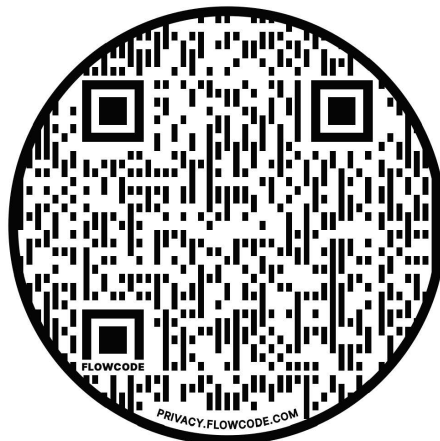


**Fig. 16**



KEY:	
LL	= Light Lean
HL	= Heavy Lean
L	= Level

SCAN THE QR CODE  
FOR VIDEO  
INSTRUCTIONS!

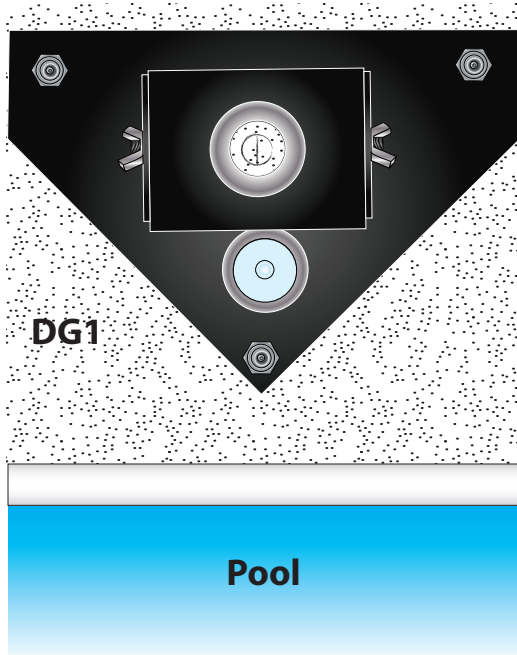


### Step 3: Drilling and Inserting Ground Sleeves

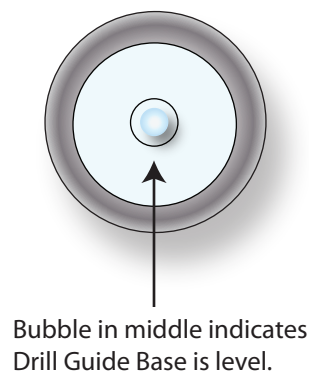
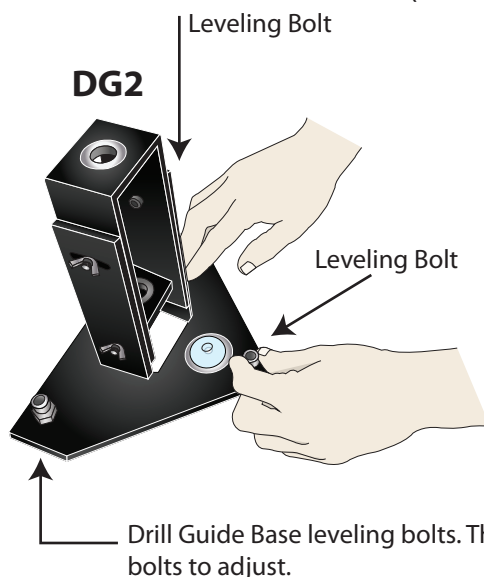
- **\*Recommended\* Drill Guide:** We have a drill guide that will help you with drilling holes needed for proper installation.

If you are unsure about any steps call **561-316-6418**.

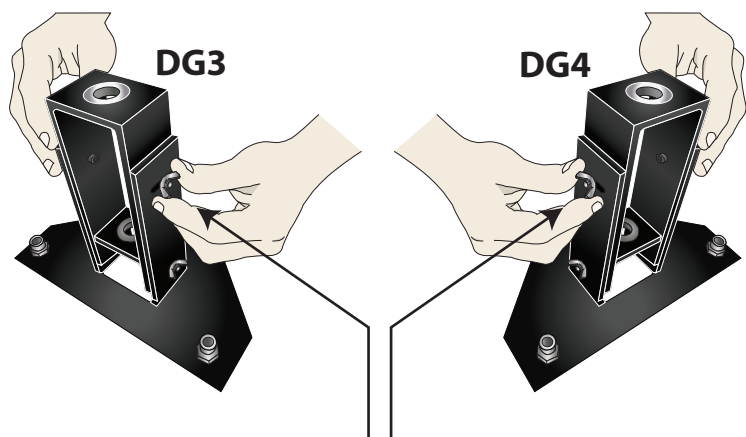
**Align:** The drill guide over the marked hole with the bubble level pointing to the pool edge. (See Fig. DG1)



**Level:** The drill guide. The three bolts attached to the bottom of the base allow the user to level the drill guide. Simply turn the bolts clockwise or counter clockwise. (See Fig. DG2)

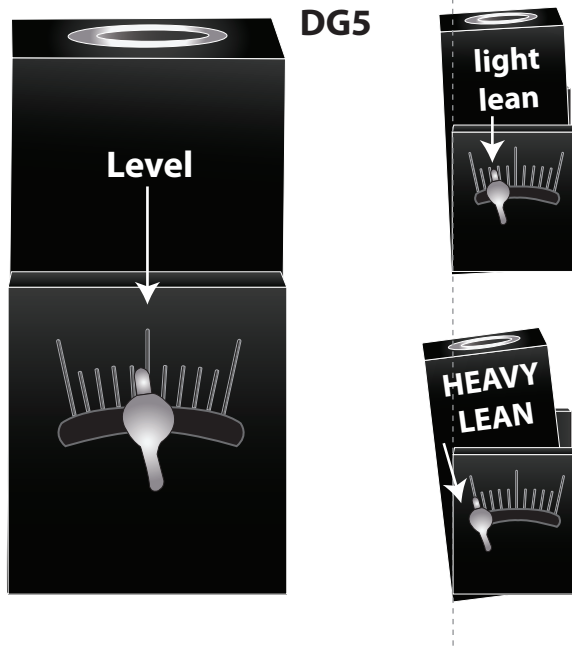


**Lean:** The guide either away from the pool, toward the pool, or at the zero mark for level drilling. To adjust the pitch simply loosen the upper wingnuts on either side of the drill guide. (See Fig. DG3 & DG4)



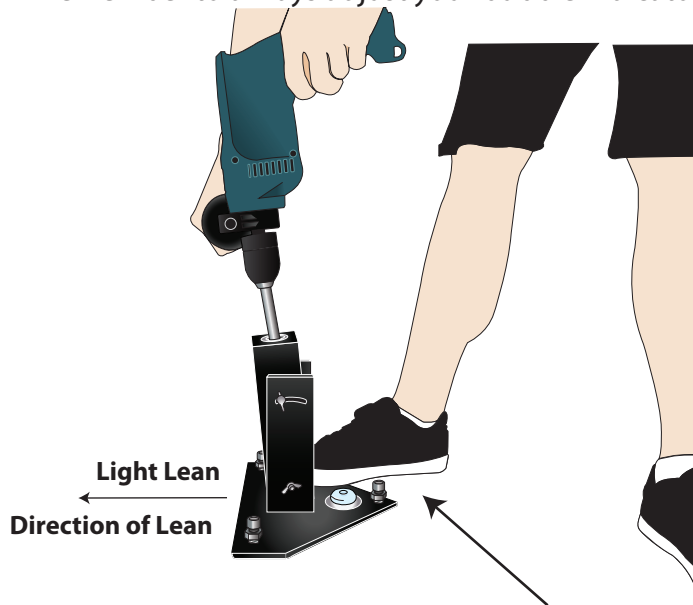
After adjustment has been made be sure to tighten wingnuts back down firmly.

**Heavy or Light Lean:** The tick marks on the side of the drill guide by the wing nut will show you what a heavy lean is and what a light lean is. (See Fig. DG5) below.



**If you are unsure about any part of these instructions please call before drilling any holes into your deck or surface (561)316-6418**

- **Drilling:** Begin at your start point to drill out fence as shown below in **Fig. 18**. Check the hole you are about to drill making sure you have the appropriate degree of lean and the direction of the hole to be drilled either towards the pool or away from the pool. In this example we are drilling away from the pool. Remember to always adjust your bubble indicator to level.



**Pro Tip: Measure twice drill once unnecessary mistakes are avoidable.**

**Fig. 18**

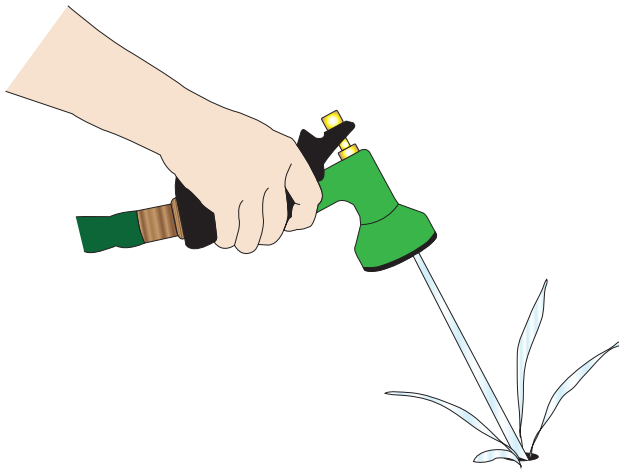
**NOTE:** Stabilize drill guide with foot pressure to prevent drill guide from shifting.

Light Lean  
Direction of Lean

**Sleeving:** Once drilling is completed, flush out the debris from the holes using a garden hose

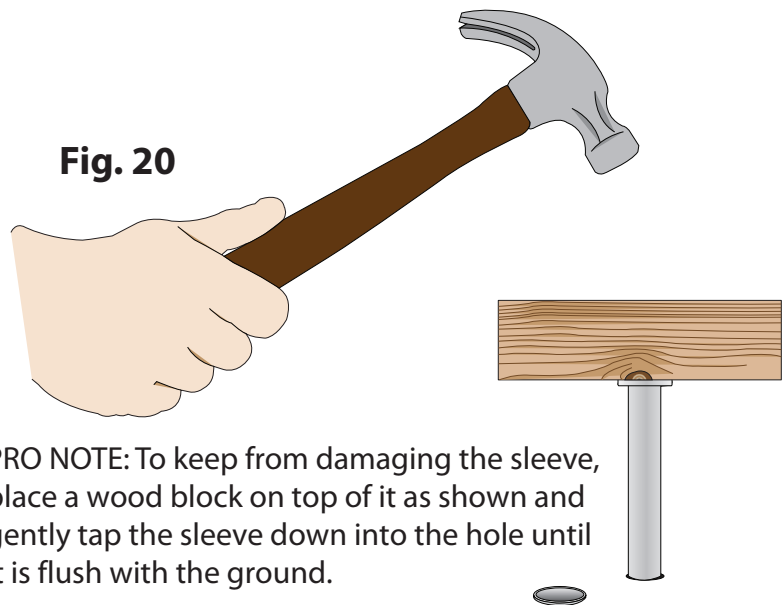
- **Fig. 19.** Next insert the plastic sleeves in the holes and tap down completely **Fig. 20.**  
**\*\*\*NOTE: IF YOU ARE INSTALLING INTO ANY SURFACE BESIDES CONCRETE GO TO [WWW.POOLFENCEDIY.COM](http://WWW.POOLFENCEDIY.COM) TO FIND THE INSTRUCTIONS FOR YOUR SURFACE**

**Fig. 19**



**Fig. 20**

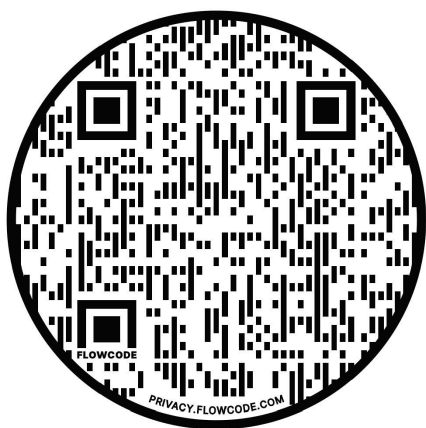
**PRO NOTE:** To keep from damaging the sleeve, place a wood block on top of it as shown and gently tap the sleeve down into the hole until it is flush with the ground.





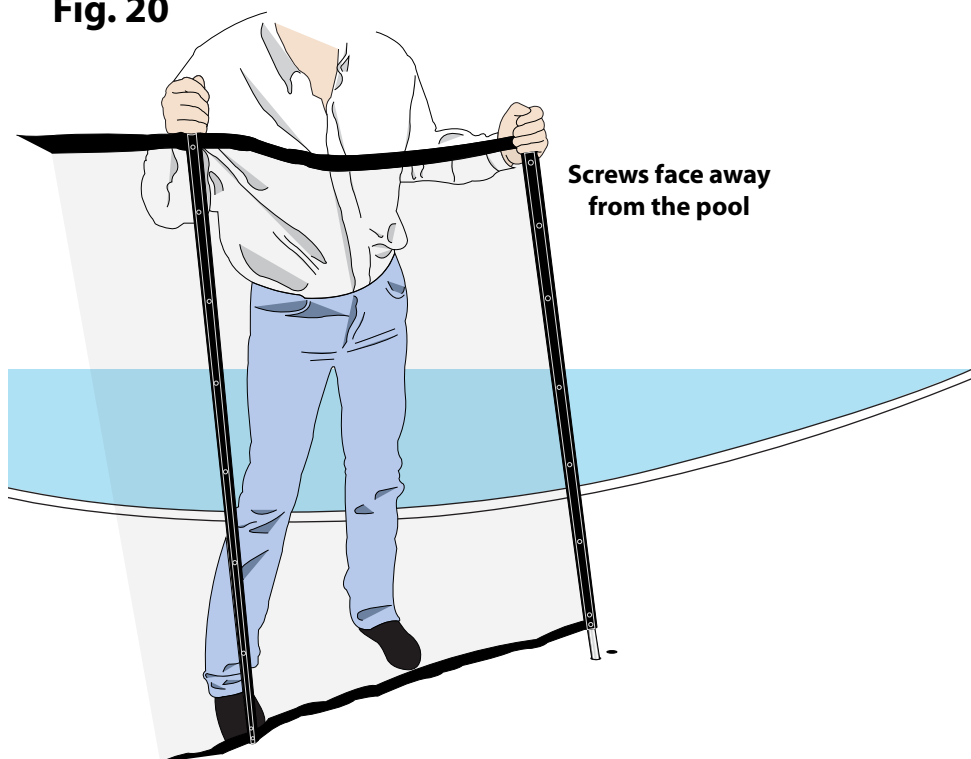
- **Installing Sections:** Start at a double hole (where sections connect) and put your first pole in. You should always lean the pole you are leading with back as shown below in **Fig. 20** to get it started in the hole. Then push the pole forward along the line of fence and down into the hole until the bottom of the fence is flush with the deck sleeve. Repeat this until all of your full sections are installed.

**SCAN THE QR CODE  
BELOW  
FOR VIDEO  
INSTRUCTIONS!**



Step 3 - Making Your Custom Cut

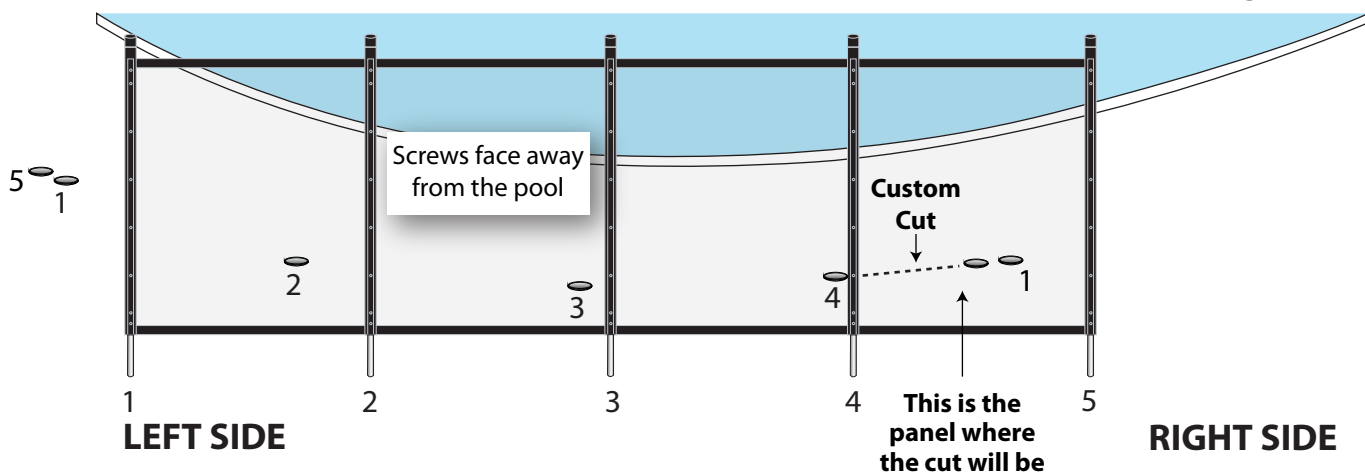
**Fig. 20**



## Step 4: Making Your Custom Cut

- **Measuring Your Custom Cut:** Your custom section is the one that doesn't fit. The first step is to measure your custom cut. Note whether you will be cutting from the right side or the left side of the full section. See **Fig. 21** below.

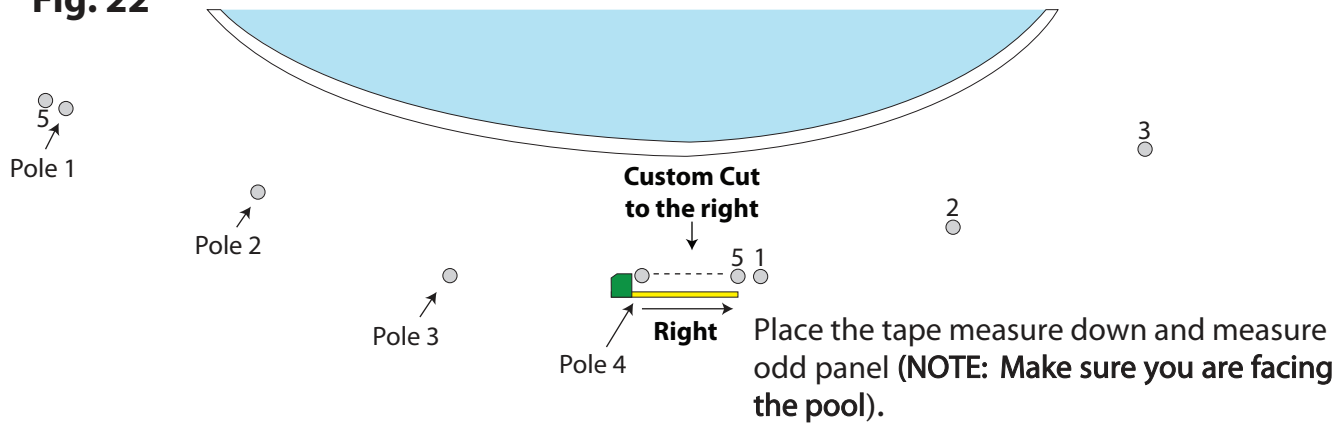
**Fig. 21**



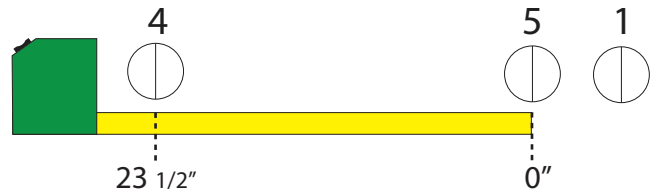
**PRO NOTE:** When measuring for a custom cut or cutting fence you should always remember that the mold-ings face out away from the pool. When measuring your cut section, always face the pool.

Measure the outside centerline of the odd panel. Next, count the number of poles in the odd section and double check whether it is a cut to the right or a cut to the left. See **Fig. 22-23**. For additional information call **561-316-6418**.

**Fig. 22**



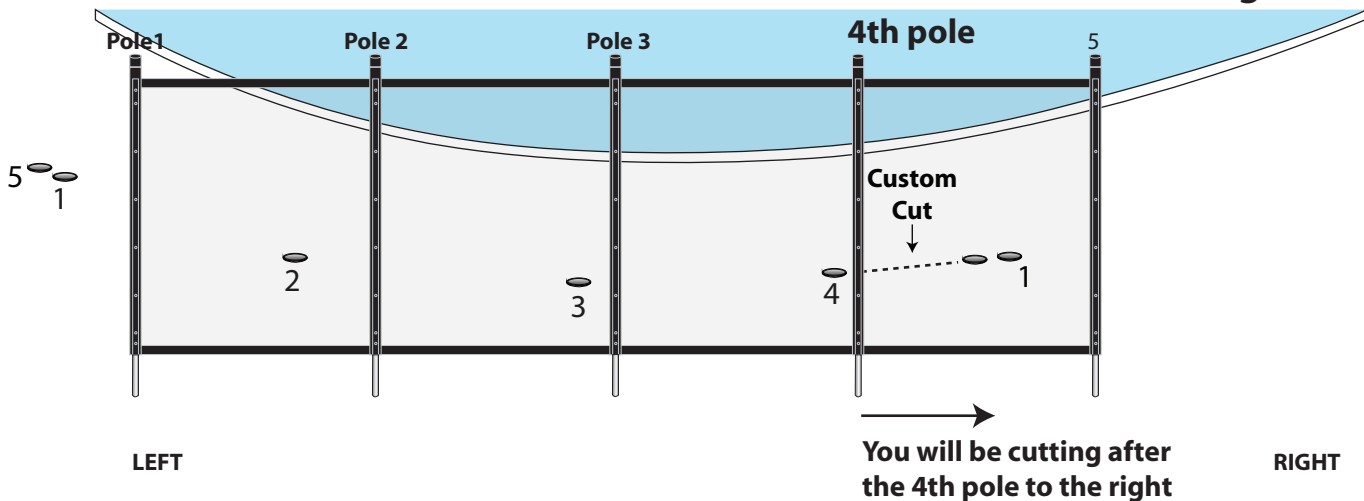
**Fig. 23**



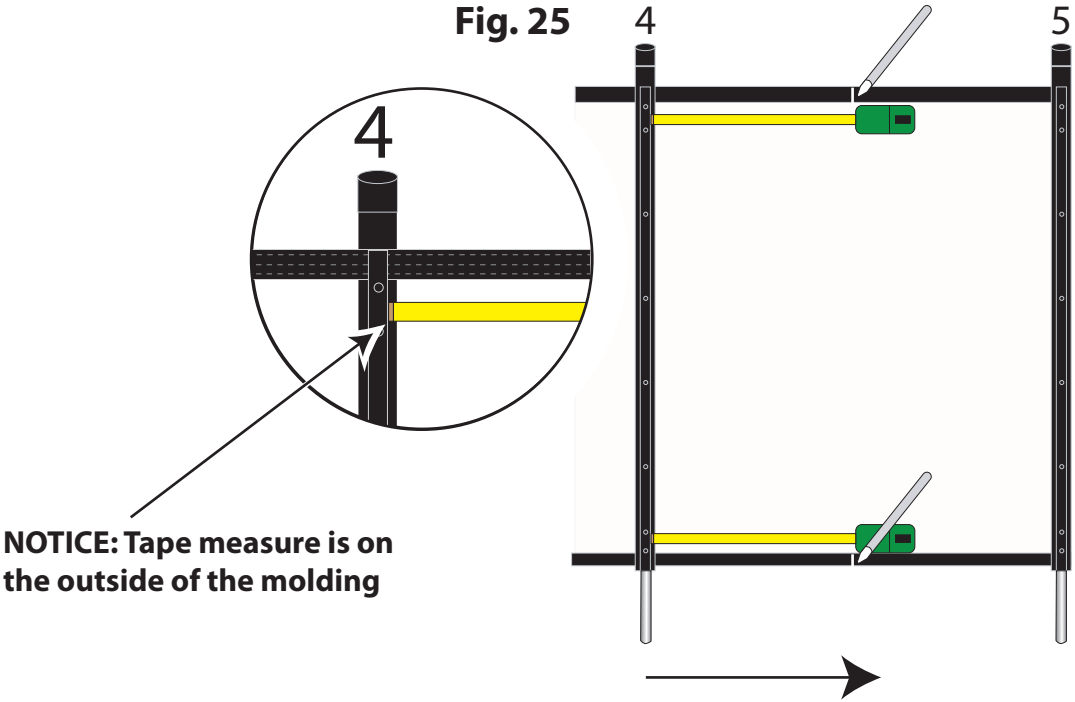
If you notice in **Fig. 22** our example custom cut is a 4 pole and then a cut to the right. Let's say this cut is a 4 pole 23 1/2" to the right. When you measure make sure you are measuring between the two centerlines of either hole. **Fig. 23** illustrates the scribe lines but, when you are ready to measure for your cut you will be dealing with drilled holes in the concrete and there will be no scribe lines drawn across the holes. The scribe lines in the figure are to remind you that if your cut happens to fall on a turn, you must remember that your center line turns as well.

- **Make Your Cut:** Now you have the measurement and you can make the cut. Roll out your full section (screws facing up) in front of the custom cut area and face the pool. Looking at the full section count the poles over until you reach the panel that needs to be cut. Our example cut is a 4 pole 23 1/2" to the right. See **Fig 24** below.

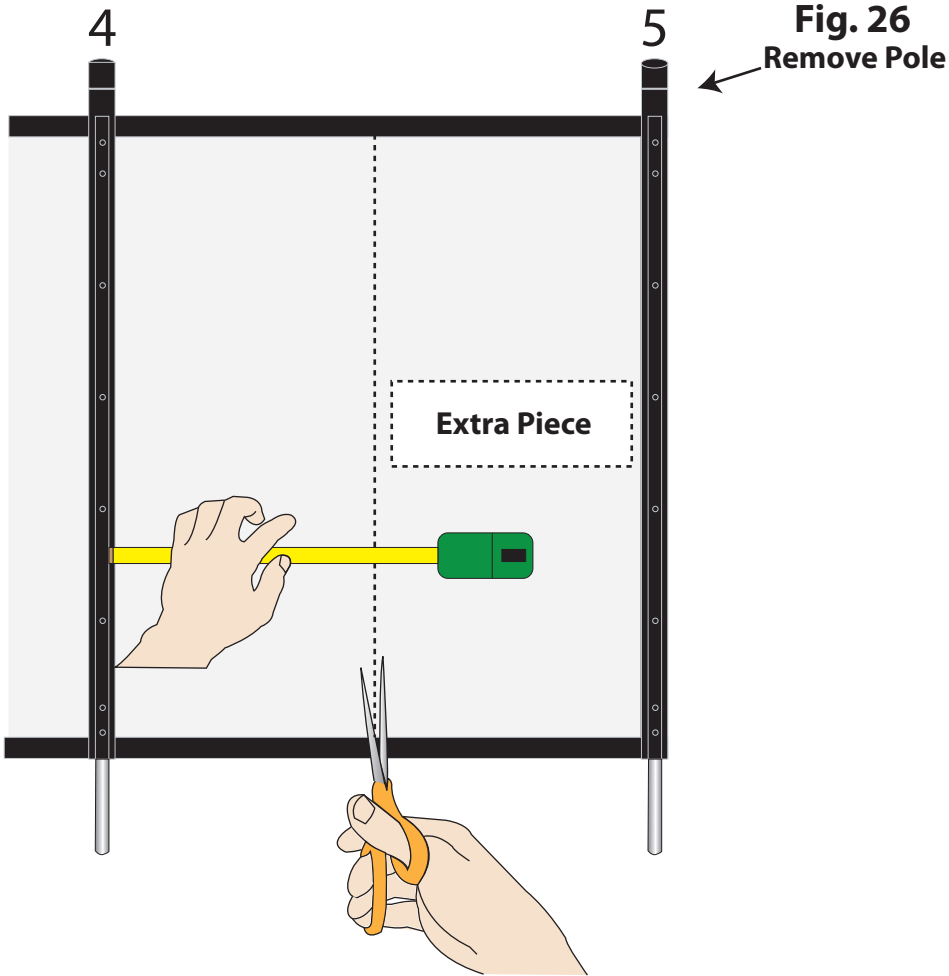
**Fig. 24**



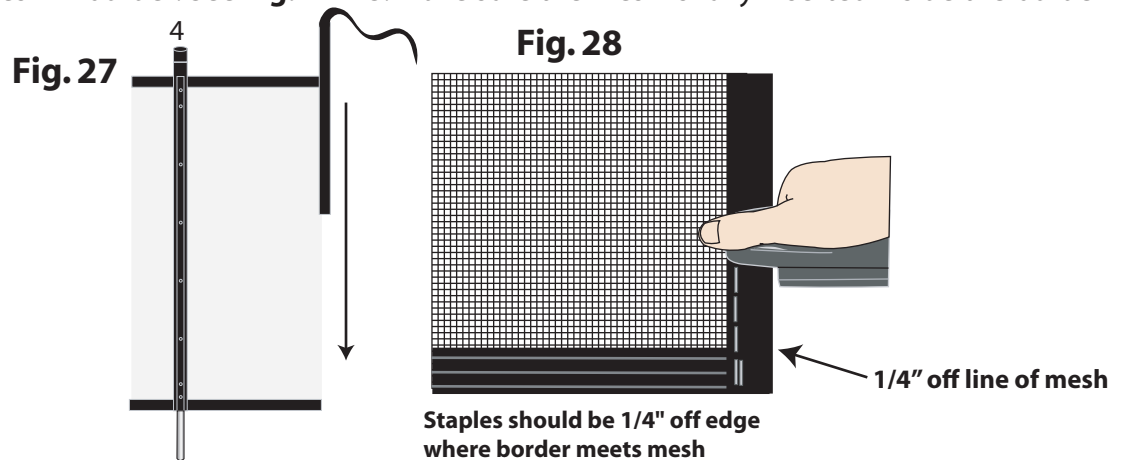
Hold your tape measure on the **OUTSIDE OF THE MOLDING** as shown in **Fig. 25** and make a mark on the border at the top and bottom of the fence with a marker.



Using your scissors you can proceed to cut the mesh. Sliding your ruler up against the molding to make sure you are cutting at exactly the measurement you took. See **Fig. 26** **Make sure the mesh is tight and remove the extra pole from the extra piece.**



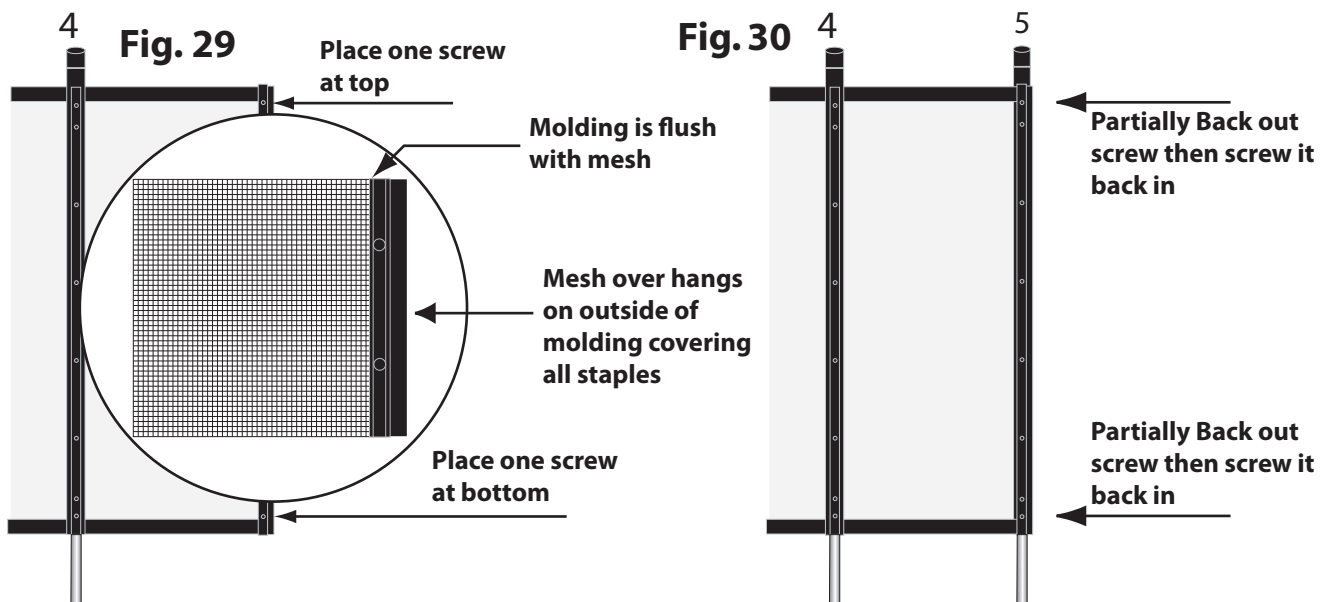
Your cut has been made and you now have to attach the border material included. Place mesh between both flaps of the border and slide the strip of border down the mesh then staple it on. Staples should be 1/4" off line of mesh in border. See **Fig. 27-28**. Make sure the mesh is fully inserted inside the border material included.



Now your border has been attached to the cut side of the mesh. Cut off excess border. Your next step is to attach the pole you removed in **Fig. 26** to the cut side.

**The best way to attach your pole to the cut is as follows:**

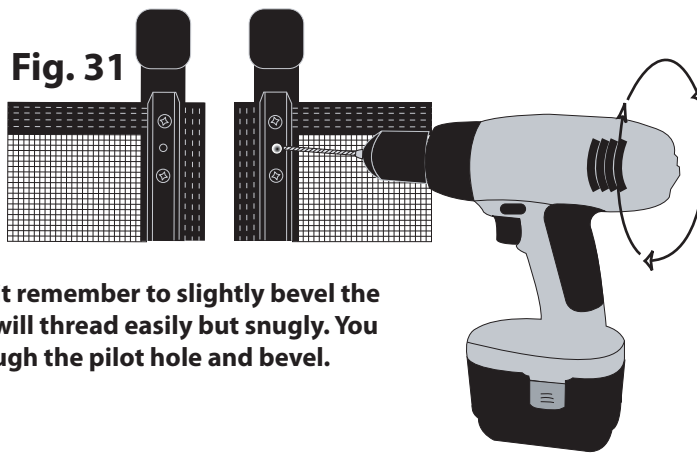
- Lay your molding strip on top of the border you just attached. **Fig. 29**
- Line up molding so that it's flush with bottom & flush with line of mesh. Make sure all staples are covered by molding **Fig. 29**.
- Screw one screw into the molding at the top until it comes completely through the molding mesh and border.
- Then put one screw into the molding at the bottom until it comes through to the other side of the molding and mesh. Your molding should now be attached with 2 screws to the cut piece of the fence.
- Slide your pole underneath the molding & mesh, and align the screws that came through the otherside to the corresponding holes of the pole. Partially back out your top screw while keeping pressure on the molding and the pole to keep it from moving. Then slowly drive the screw back down into the pole. Repeat this step for the bottom screw. See **Fig. 30**
- Finally place the rest of the screws into the pole and slowly screw them down. Your end pole is now attached. For additional information call **561-316-6418**.



SCAN THE QR CODE  
BELOW  
FOR VIDEO  
INSTRUCTIONS!

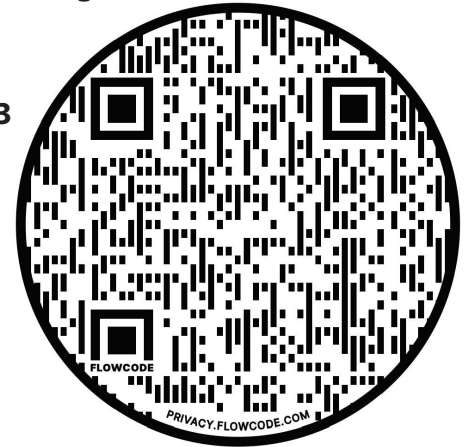
## Step 5: Finishing & Latching Your New Pool Fence D.I.Y.

- **Latching the fence:** You now have all the full sections installed and the custom cut made as well. Each full section has a pilot hole at the top between the first and second screw. Follow these steps to ensure your fence is latched properly:
  - Using your 1/8" drill bit, carefully drill out the pilot hole and slightly bevel the hole. **Fig. 31**
  - Screw one screw eye into each hole on opposing sections. **Fig. 32**
  - Squeeze the poles and clip the double hasp latch on to either screw eye. **Fig. 33**
  - Follow these steps for each section connection.



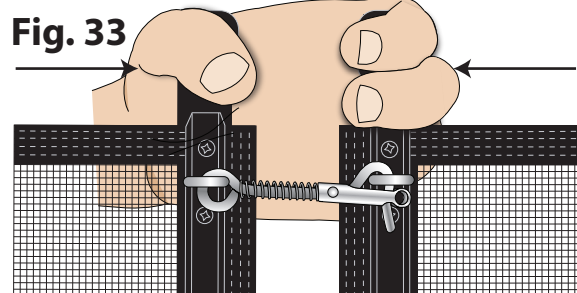
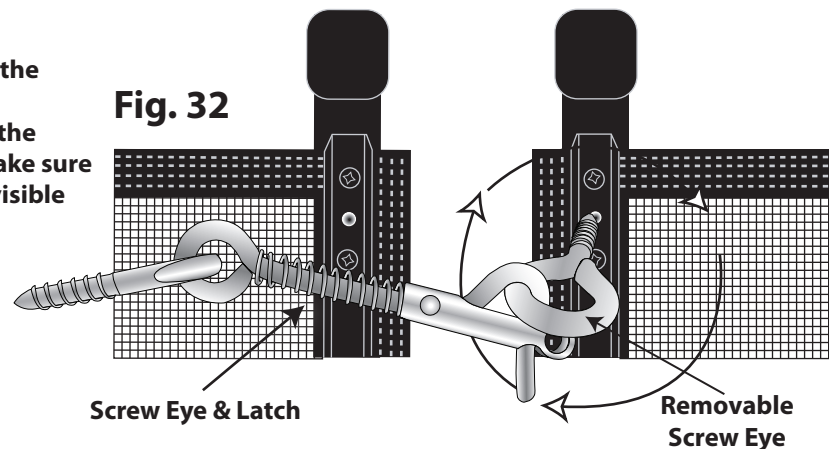
Using your 1/8" drill bit remember to slightly bevel the hole so the screw eye will thread easily but snugly. You only have to drill through the pilot hole and bevel.

Be careful not to rotate drill too fast when beveling the hole or you may brake your drill bit.



Step 4 - Putting up and Latching the Fence

Put the removable screw eye in first, as shown to the right in Fig. 32. Use the latch for leverage. Then disconnect the latch from the screw eye and turn the other screw eye in using the latch for leverage. Make sure both screw eyes are tightened until there are no visible threads.



You must squeeze poles together to remove and replace the latch.

The fence works on tension so you must squeeze the poles together in order to connect the latch to the screw eye. (TIP) Before you squeeze the poles together make sure that the poles are straight. The tension of the fence will want to twist the poles away from each other. Once you have twisted the poles as straight as you can, grab one pole and lock it between your thumb and palm by squeezing it tightly. This will help prevent the poles from twisting away from each other when you squeeze them to connect the latch.

For additional information call 561-316-6418.

**Congratulations! You have just installed your new Pool Fence D.I.Y.**

# poolfenceDIY

- **Keep gates and manual openings closed at all times.**
- **Periodically check fence for proper function.**
- **The Fence must block all entrances to the pool area.**
- **Keep fence away from staging platforms ie: tables or chairs.**
- **Leave room between fence & pool to allow for a walkway while fence is up.**
- **If fence is terminating to an existing structure, make sure the structure is solid enough and the latch can not pull out allowing a child to get through.**
- **Removable mesh safety fence is not intended to be a substitute for proper adult supervision and is not a guarantee against access to the pool.**
- **Children should always be carefully watched at all times.**
- **Layers of protection such as a fence, pool alarm, door alarm, swimming instruction, personal immersion alarms, and proper adult supervision in and around your pool can help reduce unauthorized access.**
- **If you are installing the fence to meet with code requirement check your local building codes to be sure you are in compliance with local fencing laws.**



**WARNING:**  
CHOKING HAZARD-Small parts.  
Not for children under 3 yrs.

**1085 SW 15th Ave | Suite 3 | Delray Beach, FL 33444  
For Technical Support, Call: 561-316-6418**