

# Pro Logic

Automation and Chlorination



## Operation Manual

for models

PL-PS-4

PL-PS-8



PL-PS-16

PL-PS-8-V

PL-PS-16-V

# **IMPORTANT SAFETY INSTRUCTIONS**

When using this electrical equipment, basic safety precautions should always be followed, including the following:

- **READ AND FOLLOW ALL INSTRUCTIONS**
-  **WARNING: Disconnect all AC power during installation.**
-  **WARNING: Water in excess of 100 degrees Fahrenheit may be hazardous to your health.**
-  **WARNING: To reduce the risk of injury, do not permit children to use this product unless they are closely supervised at all times.**
- A green colored terminal marked “Grounding” is located inside the wiring compartment. To reduce the risk of electric shock, this terminal must be connected to the grounding means provided in the electric supply service panel with a continuous copper wire equivalent in size to the circuit conductors supplying the equipment.
- One bonding lug for US models (two for Canadian models) is provided on the external surface. To reduce the risk of electric shock, connect the local common bonding grid in the area of the swimming pool, spa, or hot tub to these terminals with an insulated or bare copper conductor not smaller than 8 AWG US / 6 AWG Canada.
- All field installed metal components such as rails, ladders, drains, or other similar hardware within 3 meters of the pool, spa or hot tub shall be bonded to the equipment grounding bus with copper conductors not smaller than 8 AWG US / 6 AWG Canada.
- **SAVE THESE INSTRUCTIONS**

# Table of Contents

<b>System Overview</b>	Block Diagram.....	1
	Automation.....	1
	Chlorination.....	2
	Default Display.....	2
<b>Manual System Operation</b>	Output Names.....	3
	Filter Pump.....	3
	Lights and Aux Outputs.....	4
	Pool/Spa Valves.....	4
	Heaters.....	5
	System Off.....	5
	Service.....	5
<b>Automatic System Operation (Programming)</b>	Using the Programming Buttons.....	6
	Programming Menu Flow Chart.....	7
	Settings Menu.....	8
	Timers Menu.....	12
	Group Function.....	15
	Configuration Menu.....	17
	Maintenance Menu.....	32
<b>Quick “How To” Guide</b>	Operate the Spa - Manually.....	33
	Operate the Spa - Automatically.....	33
	Set the Heater Temperature.....	33
	Set the Chlorinator Output .....	33
	Start/Stop Superchlorination.....	34
	Program a Timeclock.....	34
	Program a Countdown Timer.....	34
	Enter/Exit Service Mode.....	34
<b>Chlorinator Operation/ Water Chemistry</b>	Saturation Index.....	35
	Salt Level.....	36
	Type of Salt.....	36
	How to Add or Remove Salt.....	36
<b>System Maintenance</b>	Servicing and Cleaning the Chlorinator Cell.....	39
	Winterizing.....	39
	Spring Startup.....	39
<b>Troubleshooting &amp; Diagnostic Information</b>	Service Mode .....	40
	Check System Indicator.....	40
	Diagnostic Menu.....	42
<b>Warranty</b>	Pro Logic Warranty.....	48

# System Overview

The Hayward Pro Logic is a multifunction pool controller used to fully manage your pool/spa system. The Pro Logic can control pumps, valves, lighting, heaters, and chlorination. Although the Pro Logic is easy to use, it is important to completely read through this operating manual before attempting to operate the control.

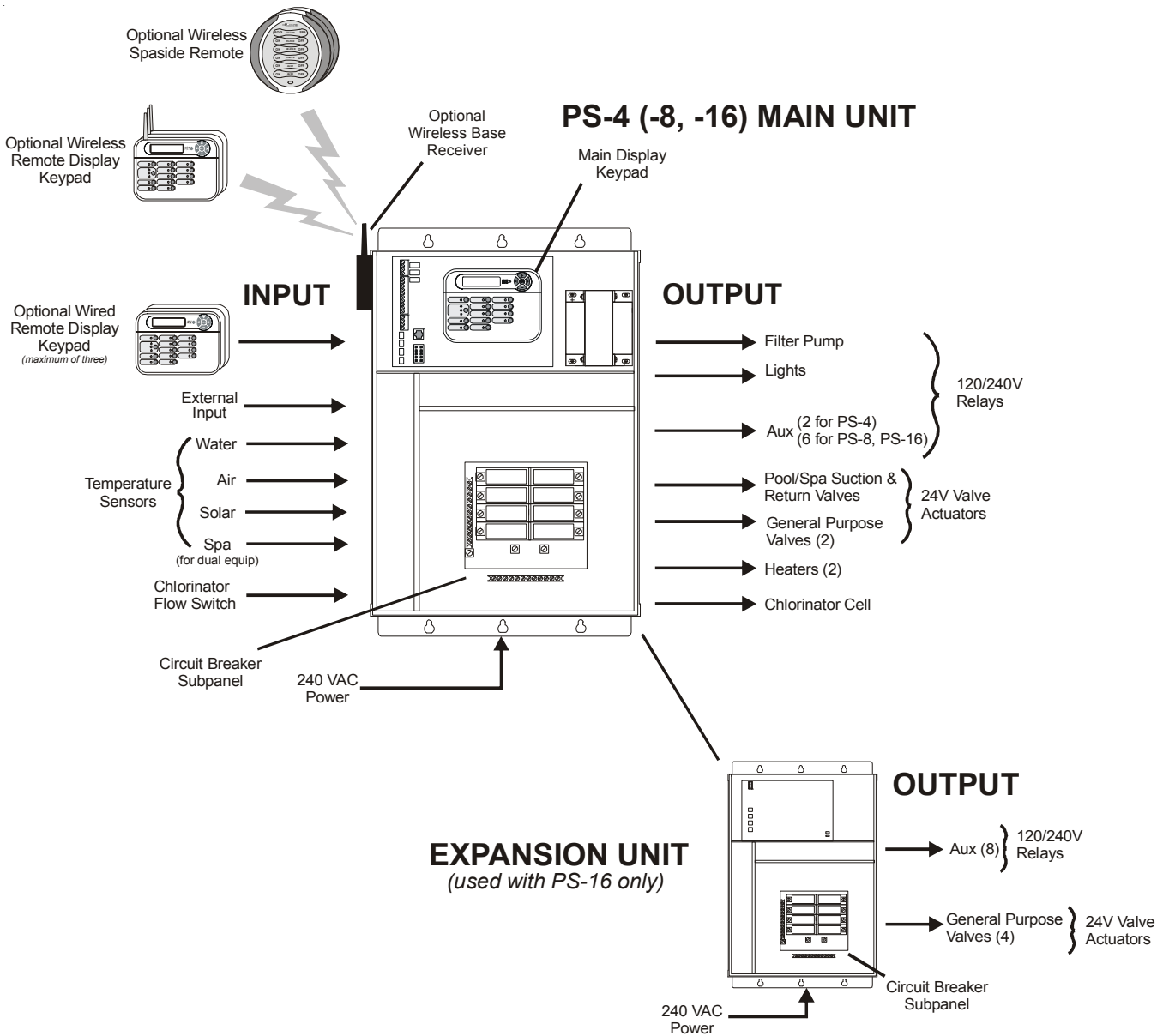

NOTE: This manual assumes that the Pro Logic has been wired and configured according to the Installation Manual. Aspects of the Pro Logic that pertain to system setup are not covered in this manual.

## Automation

The PL-PS-4 (-8, -16) can control up to 4 (8, 16) high voltage (120/240V) pieces of equipment, up to 4 (8 for the PS-16) automatic valve actuators, and 2 conventional heaters plus a solar heater. Both manual and automatic (programmed) operation are available. All of the control functions can be programmed at a display/keypad which is part of the main unit (typically located near the pool equipment) or at one or more remote display/keypads.

## Chlorination

When the chlorinator function is enabled (requires a chlorinator cell and P-KIT sold separately), the Pro Logic is also an automatic chlorine generation system for pool and/or spa sanitization. If enabled (see Configuration Menu), this operation requires a low concentration of salt (sodium chloride) in the pool/spa water. The Pro Logic automatically converts the salt into free chlorine which kills bacteria and algae in the pool/spa. Chlorine will revert back to sodium chloride after killing bacteria. These reactions will continuously recycle, virtually eliminating the need to add sanitizing chemicals to your pool/spa. The only time you may need to add more salt to the pool/spa is when water is replenished due to backwashing, draining, or splashing (not evaporation).

The Pro Logic is designed to handle the purification needs of most residential swimming pools up to 40,000 gallons (150,000 liters), or the needs of most commercial pools up to 25,000 gallons (95,000 liters). Check local codes for other restrictions. The actual amount of chlorination required to properly sanitize a pool varies due to bather load, rainfall, temperature, and the pool's cleanliness.

For pools larger than 40,000 gallons, the Pro Logic can control one or more Hayward Aqua Rite chlorinators to supplement chlorine production.

NOTE: Before installing this product as part of a saline water purification system in a pool or spa using natural stone for coping or for immediately adjacent patios/decking, a qualified stone installation specialist should be consulted regarding the appropriate type, installation, sealant (if any) and maintenance of stone used around a saline pool with electronic chlorine generator in your particular location and circumstances.

NOTE: The use of dry acid (sodium bisulfate) to adjust pool pH is discouraged especially in arid regions where pool water is subject to excessive evaporation and is not commonly diluted with fresh water. Dry acid can cause a buildup of by-products that can damage your chlorinator cell.

## Default Display

Turn power on at the main panel and turn the Pro Logic control power circuit breaker on. The keypad will show the default display. The default display alternates between the day/time, air and pool (or spa) temperature, pool/spa sanitizer setting, and salt level. Under certain circumstances, additional displays may be added to the default menu to inform you about system operation. Refer to the Programming Menu Flowchart on page 7 to view all possible displays. The Pro Logic will automatically scroll through all of the available default menu displays or you can press “<” or “>” to manually scroll.

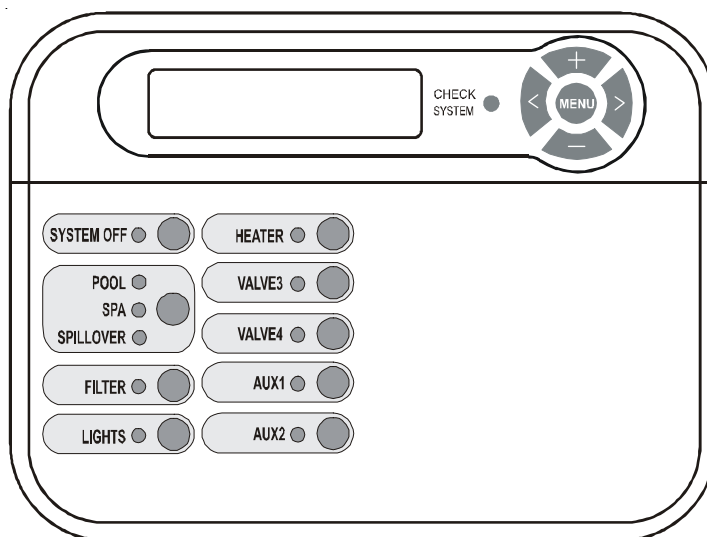

*Optional Remote Display/keypad shown--the display keypad on the main control unit will have a “Service” button in the upper left corner instead of the “System Off” button.*

# Manual System Operation

While the main objective of the Pro Logic is to automate the operation of your pool/spa system, there may be certain times when you want to override the automatic operation and control the equipment manually. To operate the pool equipment manually while keeping the automation active, perform the following procedures. Note that if you turn a relay on manually, it will remain on until either you turn it off manually, or the next time the programmed automatic operation would normally turn that relay off. Example: the filter pump is programmed to run from 9:00A to 5:00P daily. If you turn the filter pump on manually at 8:00PM, it will run continuously until the next day at 5:00PM at which time it will turn off and follow the normal program from then on. Manually turning off a relay works in a similar fashion.

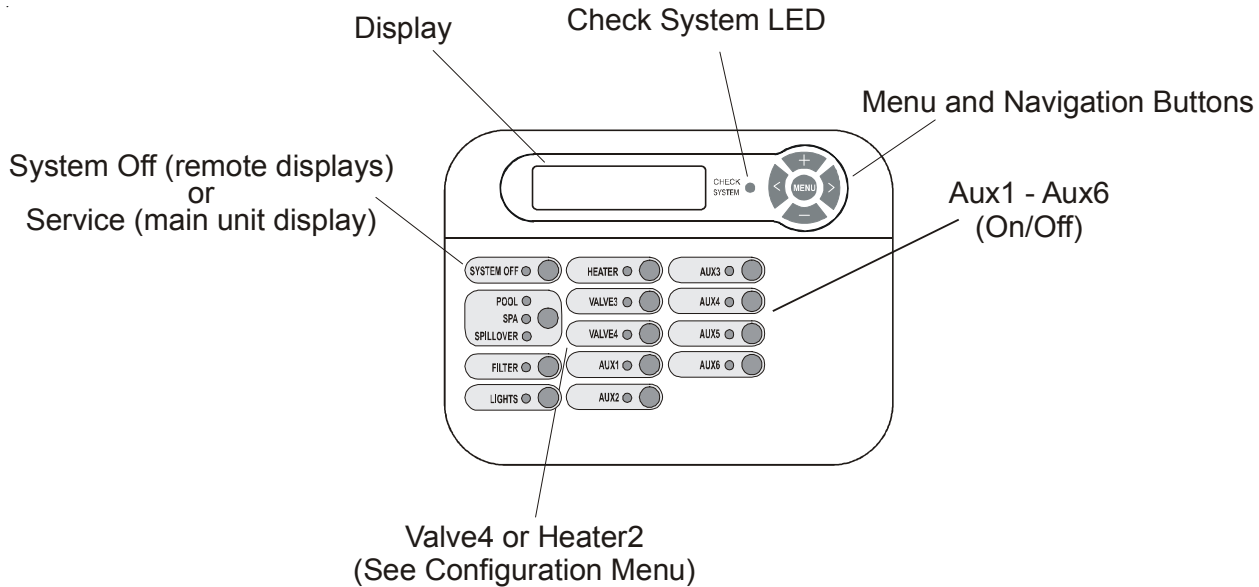

## Output Names

The Pro Logic is shipped from the factory with each output labeled with a generic name (e.g. AUX1, VALVE3, etc.). One of the features in the software (see Configuration Menu, page 17) is that each output can be assigned a new name that is more descriptive of the equipment being controlled. This makes it much easier to operate all of the equipment on your pool without having to memorize what each output controls. Insert name labels are also provided to be placed next to each display pushbutton. Since there is no way to know how your particular system is configured, this manual will use the original generic names for each output.

## Pool Filter Pump

The pool filter pump can be manually operated whether in Standard (single pump) or Dual Equipment (separate pumps for both pool and spa) mode. When in Standard mode, the display will refer to the pool filter pump as "FILTER". When in Dual Equipment mode, the display will read "POOL FILTER".

*Single Speed Filter Pump:* If the pump is currently off, press the "FILTER" button to turn on the pump. Pressing the "FILTER" button again will turn off the pump. However, if there is a heater in the system, and it is operating, and the "Heater Cooldown" feature is enabled (Configuration Menu) then: when you press the "FILTER" button to turn off the filter, only the heater will turn off, the "FILTER" LED will flash and the display will indicate "Heater Cooldown". At this point the filter pump will automatically turn off after 5 minutes of heater cooldown operation. If you want to override the heater cooldown, simply press the "FILTER" button again to turn off the filter pump.

*Two Speed Filter Pump:* If the pump is currently off, simply press the “FILTER” button to turn on high speed operation of the filter pump. The “Filter” LED will illuminate continuously. Pressing the “FILTER” button again will switch to low speed operation and the “FILTER” LED will flash. Note that if the pump has been off for more than 30 seconds, it will run at high speed for 3 minutes regardless of selection. This high speed operation helps allow the pump to prime and establish normal water flow.

*Variable Speed Filter Pump:* If the pump is currently off, press the “FILTER” button to turn the filter pump on to the last speed (1, 2, 3, or 4) that was used. A temporary display is generated indicating the current speed selection (Filter On:Spd 1). Pushing the “+” or “-” button changes the speed selection. If the pump has been off for more than 30 seconds, it will run at the highest speed for 3 minutes regardless of selection. This high speed operation helps allow the pump to prime and establish normal water flow.

*Freeze Protection:* This function protects the pool, plumbing, and equipment against freeze damage. If Freeze Protection is enabled and the AIR temperature sensor falls below the preset freeze protection temperature (see Filter Configuration), the Pro Logic will turn on the filter pump to circulate the water.

## **Spa Filter Pump (when using Dual Equipment)**

*Single Speed Filter Pump:* If the pump is currently off, press the “AUX1” button to turn on the pump. Pressing the “AUX1” button again will turn off the pump. However, if there is a heater in the system, and it is operating, and the “Heater Cooldown” feature is enabled (Configuration Menu) then: when you press the “AUX1” button to turn off the filter, only the heater will turn off, the Filter LED will flash and the display will indicate “Heater Cooldown”. At this point the filter pump will automatically turn off after 5 minutes of heater cooldown operation. If you want to override the heater cooldown, simply press the “AUX1” button again to turn off the filter pump.

*Two Speed Spa Filter Pump:* If the pump is currently off, simply press the “AUX1” button to turn on high speed operation of the filter pump. The “AUX1” LED will illuminate continuously. Pressing the “AUX1” button again will switch to low speed operation and the “AUX1” LED will flash. Note that if the pump has been off for more than 30 seconds, it will run at high speed for 3 minutes regardless of selection. This high speed operation helps allow the pump to prime and establish normal water flow.

*Variable Speed Filter Pump:* If the pump is currently off, press the “AUX1” button to turn the filter pump on to the last speed (1 or 2) that was used. A temporary display is generated indicating the current speed selection (Filter On:Spd 1). Pushing the “+” or “-” button changes the speed selection. If the pump has been off for more than 30 seconds, it will run at the highest speed for 3 minutes regardless of selection. This high speed operation helps allow the pump to prime and establish normal water flow.

*Freeze Protection:* This function protects the pool, plumbing, and equipment against freeze damage. If Freeze Protection is enabled and the AIR temperature sensor falls below the preset freeze protection temperature, the Pro Logic will turn on the spa filter pump to circulate the water.

## **Lights and Aux Outputs**

*Standard Relay:* Manual operation of all relays (LIGHTS, AUX1 and AUX2 for a PS-4 model, LIGHTS, AUX1 - AUX6 for a PS-8 model, or LIGHTS, AUX1 - AUX14 for a PS-16 model) is identical. Assuming that the relay is currently off, simply press the appropriate button to turn on the relay. If the relay does not turn on, it probably is due to the “interlock” feature (which was set up in the Configuration Menu) being activated that requires the filter pump to be running and the valves to be in the pool-only position. This protects pumps and other equipment from possible damage. If the controlled output is on, pressing the appropriate button again will turn off the relay. Manual turn off is disabled if the “Freeze Protection” feature is enabled and the air temperature is less than the selected freeze temperature threshold.

*Dimmer Relay:* If Lights or an Aux output is configured as a dimmer, pressing the corresponding button will generate a temporary display which shows the dimmer output level (Off - On 100%). Pushing the “+” or “-” button changes the level in increments of 20%. When the desired output level is displayed, press the corresponding button again to turn off the display and return to normal operation. When the Lights or Aux output comes on again (either manually or automatically), the dimmer output level will be the same as the last time that it was set.

*ColorLogic Relay:* This selection will only appear if an optional ColorLogic Network Module (AQL-COLOR-MODHV) is detected at startup. The Network Module allows the Pro Logic to control custom colors and light shows in Hayward Generation 4 or later ColorLogic pool and spa lights. Refer to the AQL-COLOR-MODHV manual for details on how to configure an Aux output for use with these lights. If a ColorLogic Module is detected at power up, the Lights relay is under automatic control and is used to power the ColorLogic lights.

*VSP Relay:* This selection is used to configure a Lights/Aux output to supply power and control a Hayward Variable Speed pump (VSP).

## Pool/Spa Valves

*Pool-only or Spa-only systems:* The POOL/SPA/SPILLOVER button has no function.

*Standard Pool and Spa systems without spa spillover:* In pool-only mode (“POOL” LED illuminated), press the “POOL/SPA/SPILLOVER” button to switch to spa-only operation (“SPA” LED illuminated). Pressing the “POOL/SPA/SPILLOVER” button again will switch back to pool-only. Note that the filter pump will turn off while the pool/spa valves are turning.

*Standard Pool and Spa systems with spa spillover:* When currently in the pool-only mode (“POOL” LED illuminated), press the “POOL/SPA/SPILLOVER” button to switch to spa-only operation (“SPA” LED illuminated). Press the button again to switch to spa spillover operation (“SPILLOVER” LED illuminated). Pressing the “POOL/SPA/SPILLOVER” button again will switch back to pool-only mode. Note that the filter pump will turn off while the pool/spa valves are turning.

*Dual Equipment Pool and Spa systems without spa spillover:* The POOL/SPA/SPILLOVER button has no function. The “POOL” LED will always be illuminated.

*Dual Equipment Pool and Spa systems with spa spillover:* When currently in the separate Pool and Spa loops mode (“POOL” LED illuminated) and the Spa Filter is off, press the POOL/SPA/SPILLOVER button to switch to spa spillover operation (“SPILLOVER” LED illuminated). Press the POOL/SPA/SPILLOVER button again to return to the separate Pool and Spa loops mode of operation. Note that the Pool Filter pump will shut off while the pool/spa return valve is turning. The system will automatically switch out of spillover whenever the spa filter pump is turned on.

NOTE: For Dual Equipment Pool and Spa systems, there is no Spa Only mode.

## Heaters

This description applies to Heater1 and to Heater2, if programmed (note that the function of the Valve4 button changes to Heater2 when Heater2 is enabled). Pressing the “HEATER” button causes the Pro Logic to switch the heater control output between a “forced off” state and a normal, automatic thermostatic control operating state.

## System Off

Each remote display/keypad has a red “SYSTEM OFF” button on the upper left corner of the keypad. Pressing this button will turn all outputs off and they will remain off, regardless of any programmed control logic, until either the “SYSTEM OFF” button (on any remote display/keypad) is pressed again or the “SERVICE” button is pressed on the display/keypad at the main unit. The red “SYSTEM OFF” LED will illuminate to indicate that all outputs and being forced off.

 **WARNING: pressing the “SYSTEM OFF” button overrides any programmed freeze protection and may cause damage to your system in freezing conditions.**

## Service

The main unit keypad has a “SERVICE” key. This button is used primarily during servicing of the pool equipment. If you want to completely disable the automatic operation and operate the system manually, you can put the system into Service or Service-Timed mode by pressing the “SERVICE” button. Pressing the “SERVICE” button once will switch the system into service mode which means that all automatic functions are disabled, and the remote display/keypads are disabled (except for manual turn off for emergencies). The red “SERVICE” LED will be illuminated and the Pro Logic will remain in this mode of operation until manually taken out of service mode.

Pressing the “SERVICE” button again will cause the Pro Logic to switch to service-timed mode which is very similar to service mode, except that the Pro Logic will automatically return to normal operation after 3 hours. During service timed operation, the “SERVICE” LED will flash and the time remaining will be displayed on the remote display keypad(s).

Pressing the “SERVICE” button again, will return the Pro Logic to normal (automatic) operation. See Troubleshooting/Diagnostic Information for more information about the service modes.



# Automatic System Operation

The Pro Logic controls most of your pool equipment automatically in order to minimize the time spent working on your pool. Most of the pool equipment can be programmed to operate on a timeclock basis. In addition, the desired pool and spa temperatures and pool and spa chlorinator settings can be programmed. This section will guide you on how to program the automatic operation for each function.



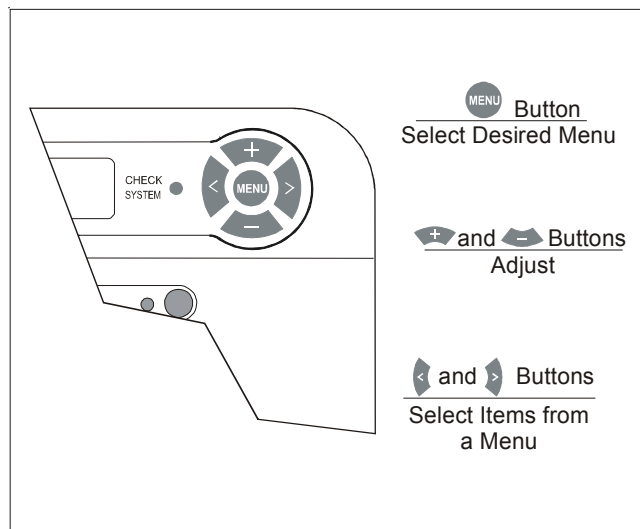

The programming of automatic functions can be performed at either the main display/keypad located at the pool equipment pad or the in-home remote display/keypad.

## Using the programming buttons

There are 5 buttons on each keypad that are used for programming (refer to diagram).



There are 4 steps to programming any function:

-  Press the “MENU” button to get to the desired menu. Multiple pushes of the button will rotate through all 6 menus and return to the starting point.
-  Press either key to scroll through the various items in the selected menu. Multiple pushes of the button will rotate through all menu items and return to the starting point. Only menu items that are applicable to your pool will appear. (Example: if you don't have a spa, then no spa related menu items will appear).
-  Once a menu item has been selected above, the current setting/selection will appear (flashing) on the display. Use the “+” and/or “-” keys to change this selection. Sometimes “+” and “-” will adjust a value up or down (example: heater temperature setting or timeclock on/off time). In this case, pushing the “+” or “-” will change the value by one increment and holding the “+” or “-” button in for more than one second will make the values auto scroll. In other cases, the “+” and “-” may toggle between 2 options (example: turning superchlorination ON or OFF).
-   After you have adjusted the item to the desired value, simply move on to the next menu item to “lock in” your new setting. The Pro Logic memory will maintain the setting, even if power is removed for an extended period.

# Programming Menu Flowchart

■ denotes conditional items

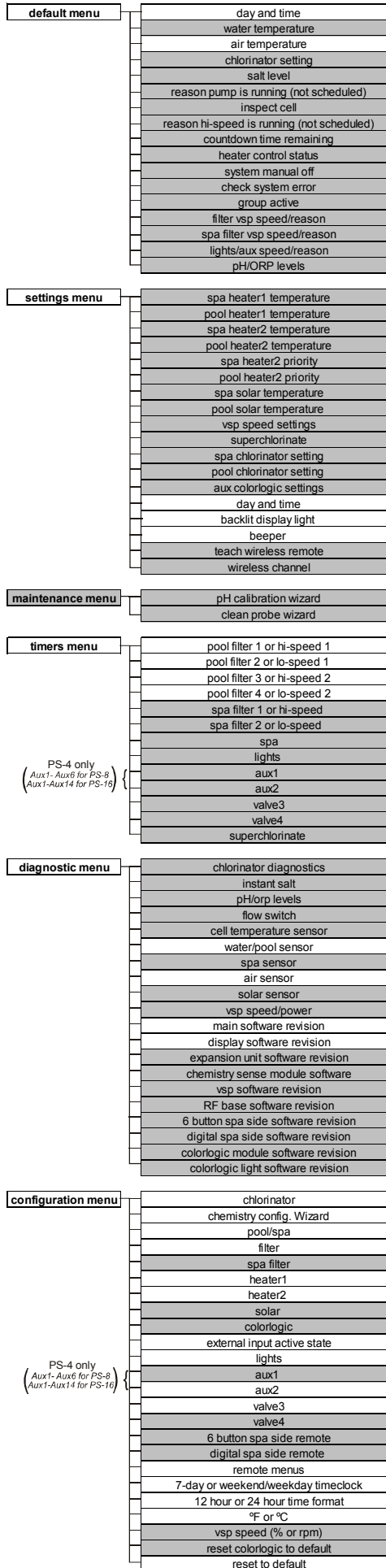

PS-4 only  
{ Aux1-Aux6 for PS-8  
Aux1-Aux14 for PS-16 }

PS-4 only  
{ Aux1-Aux6 for PS-8  
Aux1-Aux14 for PS-16 }

The Pro Logic's six main menus have many items in each that allow you to customize the operation of your pool/spa equipment. The chart on the previous page shows the Pro Logic's six menus as well as each menu's specific settings.

The Default Menu is a series of informative displays (temperatures, salt levels, chlorinator settings, etc.) with nothing to set. The Pro Logic will automatically switch to the default menu when no keys have been pressed for 2 minutes and will then scroll through each display.

The Settings Menu and the Timers Menu are the menus you will be using most often to adjust the operation of your pool. The Configuration Menu is used when the system is installed and defines what equipment is connected to each output and the operational logic that will control the equipment. This menu is normally "locked" and should only be used by a pool professional. Details regarding the Configuration menu can be found on page 17.

The "Diagnostic Menu" is primarily intended for the service technician and contains information and details about the system operation that are helpful in troubleshooting, if problems occur.

The "Maintenance Menu" will be displayed only if the optional AQL-CHEM is used and the Sensing System is enabled in the Chemistry Config. Wizard. This menu is used to perform functions relating to the AQL-CHEM ORP and pH sensing kit.

## Settings Menu

The Settings Menu allows you to set all system operating parameters except the timeclock and countdown timers which are part of the Timers Menu.

 **Important: All of the displays shown below use the default generic names for each function or output. The Pro Logic allows more descriptive names to be assigned to each piece of equipment (refer to the section regarding the Configuration Menu for more information).**

Spa Heater1 Off	+- Adjust the desired spa temperature (Off, 65°F, 66°F, ...103°F, 104°F, Off) <> Move to previous/next menu item
<i>not shown if Pool and Spa-Dual with separate heaters is selected</i>	
Spa Heater2 102°F	+- Adjust the desired spa temperature (Off, 65°F, 66°F, ...103°F, 104°F, Off) <> Move to previous/next menu item

The spa heater setting will only appear if the system has been setup for "spa only" or "pool and spa" operation and the "Heater1" and/or "Heater2" control is enabled. The heater will turn on whenever the pool/spa valves are in the "spa only" position and the filter pump is running and the spa water temperature is less than the desired temperature setting. If you have both solar heat and a conventional heater and the solar priority option is selected (Configuration Menu), then the conventional heater will only operate when solar heat is NOT available.

For Pool and Spa dual equipment with separate heaters ("Pool and Spa -Dual" and "Htr1=Spa, Htr2=Pool" selected), Spa Heater1 is tied to the Spa Filter (AUX1).

<i>not shown if Pool and Spa-Dual with separate heaters is selected</i>	
Pool Heater1 Off	+- Adjust the desired pool temperature (Off, 65°F, 66°F, ...103°F, 104°F, Off) <> Move to previous/next menu item
Pool Heater2 85°F	+- Adjust the desired pool temperature (Off, 65°F, 66°F, ...103°F, 104°F, Off) <> Move to previous/next menu item

The pool heater setting will only appear if the system has been setup for "pool only" or "pool and spa" operation and the "Heater1" and/or "Heater2" control is enabled. The heater will turn on whenever the pool/spa valves are in the "pool only" or "spa spillover" position and the filter pump is running and the pool water temperature is less than the desired temperature setting. If you have both solar heat and a conventional heater and the solar priority option is selected (Configuration Menu), then the conventional heater will only operate when solar heat is NOT available.

For Pool and Spa dual equipment with separate heaters ("Pool and Spa -Dual" and "Htr1=Spa, Htr2=Pool" selected), Pool Heater2 is tied to the Pool Filter (FILTER).

Spa Heater2  
Priority: 10 hours

+ - Adjust the desired priority interval (Never, 1hr, 2hrs, 3hrs ...22hrs, 23hrs, Always)  
<> Move to previous/next menu item

The spa heater priority setting will only appear if the system has been setup for “spa only” or “pool and spa” and if priority has been enabled for Spa Heater2. Choose “Never”, “Always” or a selectable time interval. If an interval is selected, only Spa Heater2 will run when there is a call for heat. After the interval expires, both heaters will be allowed to operate until the desired temperature has been reached.

Pool Heater2  
Priority: Never

+ - Adjust the desired priority interval (Never, 1hr, 2hrs, 3hrs ...22hrs, 23hrs, Always)  
<> Move to previous/next menu item

The pool heater priority setting will only appear if the system has been setup for “pool only” or “pool and spa” and if priority has been enabled for Pool Heater2. Choose “Never”, “Always” or a selectable time interval. If an interval is selected, only Pool Heater2 will run when there is a call for heat. After the interval expires, both heaters will be allowed to operate until the desired temperature has been reached.

Spa Solar  
102°F

+ - Adjust the desired spa temperature (Off, 65°F, 66°F, ...103°F, 104°F, Off)  
<> Move to previous/next menu item

The spa solar setting will only appear if the system has been setup for “spa only” or “pool and spa” operation and the solar control is enabled. The solar system will turn on whenever the pool/spa valves are in the “spa only” position and the filter pump is running and the spa water temperature is less than the desired temperature setting and solar heat is available.

Pool Solar  
88°F

+ - Adjust the desired pool temperature (Off, 65°F, 66°F, ...103°F, 104°F, Off)  
<> Move to previous/next menu item

The pool solar heater setting will only appear if the system has been setup for “pool only” or “pool and spa” operation and the solar control is enabled. The solar system will turn on whenever the pool/spa valves are in the “pool only” or “spa spillover” position and the filter pump is running and the pool water temperature is less than the desired temperature setting and solar heat is available.

*only if an output is configured for a variable speed pump*

VSP Speed Settings  
+ to enter

+ Push to access Variable Speed Pump Speed Settings  
<> Move to previous/next configuration menu

*only if Filter is Variable Speed*

Filter Speed 1  
95%

+ - Set the desired Filter Speed 1 from the Filter Lowest to the Filter Highest  
<> Move to next menu item

*only if Pool and Spa-Dual and Spa Filter is Variable Speed*

Spa Filter Speed 1  
95%

+ - Set the desired Spa Filter Speed 1 from the Spa Filter Lowest to Spa Filter Highest  
<> Move to next menu item

*only if Pool and Spa-Std and Filter is Variable Speed*

Spa Speed  
50%

+ - Set the desired Spa Mode Speed from the Filter Lowest to the Filter Highest  
<> Move to next menu item

*only if Aux2 is controlled by a variable speed pump*

Aux2 Speed  
95%

+ - Set the desired Aux2 Speed from 10% to 100%  
<> Move to next menu item

The Filter, Dual Equipment Spa Filter, and up to 6 Lights and Aux outputs can be configured to control variable speed pumps. These settings allow you to select the desired speed of the variable speed pump for each output used. The speed can be displayed in % or RPM, whichever is selected in the Configuration Menu. For the Filter and Dual Equipment Spa Filter, when the output is on, the actual speed of the pump(s) will be dependent on the minimum and maximum speeds set for that output in the Configuration Menu.

Super Chlorinate  
Off

+ - Turn super chlorinate on or off  
<> Move to previous/next menu item

This display only appears if the chlorinator function is enabled. If an AQL-CHEM is being used, super chlorinate will not be available if chemical sensing is enabled and ORP is in Auto Sensing (see AQL-CHEM manual).

When you have an unusually high bather load, a large amount of rain, a cloudy water condition, or any other condition that requires a large amount of chlorine to be introduced to the pool, activate the Pro Logic Super Chlorinate function. The Pro Logic will turn on the filter pump, set the pool/spa valves to the correct position, and set the chlorine generator to maximum output. The superchlorinate function will continue for the programmed number of hours (see Timers/Super Chlorinate Hours) overriding the normal filter pump timeclock settings. At the end of the super chlorinate period, the pool will return to normal operation.

If you manually turn off the filter pump (using the “FILTER” button on any display/keypad), the super chlorinate function terminates. When you turn the filter pump back on, super chlorinate will resume for the balance of the programmed number of hours.

Spa Chlorinator  
3%

- + - Adjust the desired chlorinator output for spa (0,1,2,3...9,10,15,20...95,100%)
- <> Move to previous/next menu item

This setting will appear only if the chlorinator function is enabled and system has been setup for “spa only” or “pool and spa-std”. If an AQL-CHEM is being used, super chlorinate will not be available if chemical sensing is enabled and ORP is in Auto Sensing (see AQL-CHEM manual). It will determine the chlorinator output when the system is operating in spa-only mode. The actual amount of chlorine introduced into the spa is determined by: this setting, the amount of time the pool operates in spa-only mode, the water temperature, and the amount of salt in the water. If the filter pump is running due to the freeze protection feature, then the chlorinator will not operate during this time.

Pool Chlorinator  
60%

- + - Adjust the desired chlorinator output for pool (0,1,2,3...9,10,15,20...95,100%)
- <> Move to previous/next menu item

This setting will appear only if the chlorinator function is enabled and system has been setup for “pool only” or “pool and spa”. If an AQL-CHEM is being used, super chlorinate will not be available if chemical sensing is enabled and ORP is in Auto Sensing (see AQL-CHEM manual). It will determine the chlorinator output when the system is operating in pool-only or spa spillover modes. The actual amount of chlorine introduced into the pool is determined by: this setting, the amount of time the filter pump is running, the water temperature, and the amount of salt in the water. If the filter pump is running due to the freeze protection feature, then the chlorinator will not operate during this time.

Pool High Speed  
100%

- + - Adjust the desired high speed for variable speed operation
- <> Move to previous/next menu item

This setting will appear if “spa only” is not selected and variable speed filter pump is enabled. This setting determines the speed of the pump during high speed pool or spillover operation. This value can be set from 20% to “Highest Speed” in 5% increments. “Highest Speed” is default.

For PS models using dual equipment, this is the pool filter high speed.

Pool Low Speed  
50%

- + - Adjust the desired low speed for variable speed operation
- <> Move to previous/next menu item

This setting will appear if “spa only” is not selected and variable speed filter pump is enabled. This setting determines the speed of the pump during low speed pool or spillover operation. This value can be set from “Lowest Speed” to 50% in 5% increments. 50% is default.

For PS models using dual equipment, this is the pool filter low speed.

*if Aux1 is configured as “ColorLogic”*

Aux1 Settings  
+ to view/change

- + Push to access ColorLogic settings
- <> Move to previous/next menu item

This menu will appear if an aux has been configured as “ColorLogic”. Use this menu to select custom colors and lightshows for your networked ColorLogic lights. Refer to the AQL-COLOR-MODHV manual for specific information on these settings.

- Set Day and Time  
**Wednesday 10:37P**

 +- Adjust the current day of the week  
 <> Move to hours setting
- Set Day and Time  
 Wednesday **10:37P**

 +- Adjust the current hour (including AM/PM if applicable)  
 <> Move to minutes setting
- Set Day and Time  
 Wednesday 10:**37P**

 +- Adjust the current minute  
 <> Move to previous/next menu item

Use this function to set the current day of the week and time. These values are used for all the automatic timeclock functions of the Pro Logic and are also displayed as part of the default menu.

The Pro Logic is designed to keep the clock running during power outages lasting less than 7 days. If power has been off for longer than 7 days, then the time may have to be reset.

- Display Light  
 On for 60 sec

 +- Toggle between Always On and On for 60 sec.  
 <> Move to previous/next menu item

This function controls the backlight on the display. If the “On for 60 seconds” option is selected, then the backlight will automatically turn off 60 seconds after the last key is pressed and will stay off until next time a key is pressed.

Note that the Display Light selection only applies to the display keypad that you are currently using. Other display/keypads will not be affected. You need to individually set this option for each display/keypad in the system.

- Beeper  
 Enabled

 +- Toggle between Enabled (default) and Disabled Beeper  
 <> Move to previous/next menu item

When “Enabled”, the keypad will beep every time a key is pressed. If this audible indication is not desired, select “Disabled”.

This function only applies to the display/keypad that you are currently using. You need to set this option for each display/keypad in your system.

NOTE: This function is not supported on all display/keypads. If the “Enabled” selection is not blinking, then the current software revision of that particular keypad/display does not support the option and it will default to Beeper Enabled.

- Teach Wireless  
 + to start

 + Push to start process  
 <> Move to previous/next menu item
- Press and hold  
 wireless button

 Press any button on wireless remote  
 <> Move to previous/next menu item
- Teach Wireless  
 Successful

 <> Move to previous/next menu item
- Teach Wireless  
 NOT Successful

 <> Move to previous/next menu item
- Teach Wireless  
 Base NOT Found

 <> Move to previous/next menu item

This menu will only appear if a wireless base station is connected to the Pro Logic. Perform this procedure each time a wireless remote control is added to the Pro Logic system. During this procedure the wireless remote “learns” and remembers the ID code for the wireless base station connected to this particular Pro Logic unit and will reject messages with any other ID codes. If “Base NOT found” is displayed, then the Pro Logic can not communicate with the transmitter/receiver base station attached to the main unit. If “NOT Successful” is displayed, then the base station did not receive a signal from the remote control. This may be due to the distance between the Base Receiver and the remote device being too great or may be due to interference caused by other RF equipment operating in the neighborhood. Try using the “Change Channel” command and then repeat the “Teach Wireless” command.

Wireless Channel: 1	+ - Change the desired wireless channel (1 - 5) <> If channel is changed, move to confirmation menu If channel is not changed, move to previous/next menu item
Confirm Change: + to proceed	+ Push to confirm the channel change <> Move to previous/next menu item
Reteach all wireless units	<> Move to previous (Teach Wireless) menu

This setting changes the channel to be used by the wireless base station and remote(s). If the channel is changed and confirmed, all wireless remote will have to be re-taught. This menu will only appear if a wireless base station is connected to the Pro Logic.

## Timers Menu

The Timers Menu allows you to set all timeclock and countdown timers which control the automatic operation of your pool/spa system.

Most timeclocks have a single on/off program per day. All of the timeclocks are setup (Configuration Menu) either as “all days” or “weekends/weekdays”. If “weekends/weekdays” are selected, you will need to program on times for both weekdays and weekends and off times for both weekdays and weekends, even if you want them to be the same. All times are adjusted in 15 minute increments (9:00A, 9:15A, 9:30A, etc.). If you program the on time equal to the off time (“10:00A to 10:00A”) the output will NEVER turn on. If you want to disable a timeclock, you can set the on time equal to the off time and you will notice the times disappear and the display simply shows “Off”. If, at a later time, you wish to re-activate the timeclock, simply press either the “+” or “-” buttons to go back to a normal timeclock programming display.

The Countdown timer is programmed in increments of 5 minutes from “Manual On/Off” (0 minutes) to a maximum of “21:00” (21 hours). When “Manual On/Off” is displayed, the countdown timer is disabled and the output will be manually controlled. When a countdown timer is equal or greater than “0:05”, pressing the appropriate output button will turn the output on and start the timer. Pressing the button again will turn the output off or, when the programmed time has elapsed, the output will automatically turn off.

**⚠ Important: All of the displays shown below use the default generic names for each function or output. The Pro Logic allows more descriptive names to be assigned to each piece of equipment (refer to the section regarding the Configuration Menu for more information).**

or	Filter T1-all 8:30A to 4:00P	+ - Adjust time setting <> Move between start and stop times & to previous/next menu item
	Filter T1-wkend 8:30A to 4:00P	+ - Adjust time setting <> Move between start and stop times & to previous/next menu item
	Filter T1-wkday 8:30A to 4:00P	+ - Adjust time setting <> Move between start and stop times & to previous/next menu item

For one speed pumps, this is the first filter timeclock and will determine the normal hours of filtration for the pool. For pool/spa combination systems with spillover enabled and filter operation set to “spillover”, the valves will automatically switch to spillover mode at the start of the filtration period. For pool/spa combination systems with spillover enabled and filter operation set to “pool only”, the valves will switch to the pool-only position.

For two speed pumps, this setting will be the period of time when the pump runs at high speed (the word “Filter T1” in the display will be replaced with “Filter H1”). There is a separate timeclock for the low speed operation which will be programmed next. If the high speed and low speed periods overlap, then the pump will operate in low speed during the overlap period.

For a variable speed pump, this setting will be the period of time when the pump will run at the speed selected for speed1 in the settings menu. If there is an overlap in any of the timeclocks, then the lower number timeclock/speed has priority.

Depending on the type of filter pump used, there are several reasons why the pump may be running at times other than the timeclock period set above. These include super-chlorination, spa operation, manual operation, heater cooldown, freeze protection, heater-extend and solar-extend. For variable speed pumps, when there is more than one reason for the pump to run, the speed priority in order from highest to lowest is priming (first 3 minutes after filter has been turned on), freeze protection, group, heater minimum, aux/valve override, spa mode, speed1, speed2, speed3, speed4. Note that the reason for the current speed is shown in the Default Menu.

- |                                 |  |
|---------------------------------|--|
| Filter T2-all<br>8:30A to 4:00P | + - Adjust time setting  |
|                                 | < > Move between start and stop times & to previous/next menu item |
- or
- |                                   |  |
|-----------------------------------|--|
| Filter T2-wkend<br>8:30A to 4:00P | + - Adjust time setting  |
|                                   | < > Move between start and stop times & to previous/next menu item |
- |                                   |  |
|-----------------------------------|--|
| Filter T2-wkday<br>8:30A to 4:00P | + - Adjust time setting  |
|                                   | < > Move between start and stop times & to previous/next menu item |

For one speed pumps, this is the second filter timeclock.

For two speed, this timeclock will set the normal time period for **filter pump low speed operation** (the word “Filter T2” in the display will be replaced with “Filter L1”). If the filter pump is off for more than 30 seconds, the pump will first turn on at high speed for 3 minutes to prime and establish water flow. Afterwards, it will drop down to low speed for the remainder of the programmed low speed time period. While this time clock will override the high speed timeclock (see above), there are several reasons why the pump will automatically switch to high speed operation during this programmed time period. These include manual operation, spa operation, or heating operation.

For a variable speed pump, this setting will be the period of time when the pump will run at the speed selected for speed2 in the settings menu. If there is an overlap in any of the timeclocks, then the lower number timeclock/speed has priority.

**NOTE: The third and fourth filter timeclocks function similarly to the first and second (respectively). Program these timeclocks in the same manner.**

- |                           |  |
|---------------------------|--|
| Spa-all<br>6:00P to 9:00P | + - Adjust time setting  |
|                           | < > Move between start and stop times & to previous/next menu item |
- or
- |                             |  |
|-----------------------------|--|
| Spa-wkend<br>6:00P to 9:00P | + - Adjust time setting  |
|                             | < > Move between start and stop times & to previous/next menu item |
- |                             |  |
|-----------------------------|--|
| Spa-wkday<br>6:00P to 9:00P | + - Adjust time setting  |
|                             | < > Move between start and stop times & to previous/next menu item |

This menu is only available if the system has been setup for “pool and spa-std”. During the programmed spa time, the Pro Logic will move the pool/spa valves into the “spa-only” position and turn on the filter pump. The heater will automatically heat the spa up to the programmed spa temperature. This programmed spa operation will take precedence over all other automatic functions, only manual operation of the filter button or pool/spa valve button will override this function.

If your pool has a separate jet pump or blower controlled by Aux1 and/or Aux2 , you will have to program those separately.

- |                               |  |
|-------------------------------|--|
| Lights-all<br>8:00P to 11:00P | + - Adjust time setting  |
|                               | < > Move between start and stop times & to previous/next menu item |
- or
- |                                 |  |
|---------------------------------|--|
| Lights-wkend<br>8:00P to 11:00P | + - Adjust time setting  |
|                                 | < > Move between start and stop times & to previous/next menu item |
- |                                 |  |
|---------------------------------|--|
| Lights-wkday<br>8:00P to 11:00P | + - Adjust time setting  |
|                                 | < > Move between start and stop times & to previous/next menu item |

This menu will appear only if the Lights are configured for timeclock. The lights will turn on and off at the designated times. The only override on this function is manual on/off control by the “Lights” button.

- |                        |   |
|------------------------|---|
| Lights-CountDn<br>0:20 | + - Adjust time setting (Manual On/Off, 0:05, 0:10, 0:015...) |
|                        | < > Move to previous/next menu item                           |

This menu will appear only if the Lights are configured for countdown timer. This setting is the time after you manually turn on the lights until the Pro Logic automatically turns off the lights. You can also manually turn off the lights at an earlier time by pressing the LIGHTS button.



- |                                     |   |
|-------------------------------------|---|
| Spa Filter T1-all<br>8:30A to 4:00P | +- Adjust time setting  |
|                                     | <> Move between start and stop times & to previous/next menu item |
- or
- |                                       |   |
|---------------------------------------|---|
| Spa Filter T1-wkend<br>8:30A to 4:00P | +- Adjust time setting  |
|                                       | <> Move between start and stop times & to previous/next menu item |
- |                                       |   |
|---------------------------------------|---|
| Spa Filter T1-wkday<br>8:30A to 4:00P | +- Adjust time setting  |
|                                       | <> Move between start and stop times & to previous/next menu item |

This menu is only available if the system has been setup for Dual Equipment. For one speed pumps, this is the first spa filter timeclock and will determine the normal hours of filtration for the spa. For pool/spa combination systems with spillover enabled, the valves will automatically switch to pool only at the start of the filtration period.

For two speed pumps, this setting will be the period of time when the spa pump runs at high speed (the word “Spa Filter T1” in the display will be replaced with “Spa Filter Hi”). There is a separate timeclock for the low speed operation (see below). If the high speed and low speed periods overlap, then the pump will operate in low speed during the overlap period.

For a variable speed pump, this setting will be the period of time when the pump will run at the speed selected for speed1 in the settings menu. If there is an overlap in any of the timeclocks, then the lower number timeclock/speed has priority.

- |                                     |   |
|-------------------------------------|---|
| Spa Filter T2-all<br>8:30A to 4:00P | +- Adjust time setting  |
|                                     | <> Move between start and stop times & to previous/next menu item |
- or
- |                                       |   |
|---------------------------------------|---|
| Spa Filter T2-wkend<br>8:30A to 4:00P | +- Adjust time setting  |
|                                       | <> Move between start and stop times & to previous/next menu item |
- |                                       |   |
|---------------------------------------|---|
| Spa Filter T2-wkday<br>8:30A to 4:00P | +- Adjust time setting  |
|                                       | <> Move between start and stop times & to previous/next menu item |

For one speed spa pumps, this is the second filter timeclock

For two speed pumps, this timeclock will set the normal time period for **spa filter pump low speed operation** (the word “Spa Filter T2” in the display will be replaced with “Spa Filter Lo”). If the filter pump is off for more than 30 seconds, the pump will first turn on at high speed for 3 minutes to prime and establish water flow. Afterwards, it will drop down to low speed for the remainder of the programmed low speed time period. While this time clock will override the high speed timeclock (see above), there are several reasons why the pump will automatically switch to high speed operation during this programmed time period. These include manual operation, spa operation, or heating operation.

For a variable speed pump, this setting will be the period of time when the pump will run at the speed selected for speed2 in the settings menu. If there is an overlap in any of the timeclocks, then the lower number timeclock/speed has priority.

*For PS-4, Aux1 and Aux2 configurations are identical. For PS-8 models, Aux1 - Aux6 configurations are identical. For PS-16 models, Aux1 - Aux14 configurations are identical.*

- |                            |   |
|----------------------------|---|
| Aux1-all<br>8:30A to 4:00P | +- Adjust time setting  |
|                            | <> Move between start and stop times & to previous/next menu item |
- or
- |                              |   |
|------------------------------|---|
| Aux1-wkend<br>8:30A to 4:00P | +- Adjust time setting  |
|                              | <> Move between start and stop times & to previous/next menu item |
- |                              |   |
|------------------------------|---|
| Aux1-wkday<br>8:30A to 4:00P | +- Adjust time setting  |
|                              | <> Move between start and stop times & to previous/next menu item |

This menu will appear only if the Aux1 is configured for timeclock. The Aux1 output will turn on and off at the designated times. If the Aux1 relay is off during the programmed on time—note that some pool equipment (example pressure side pool cleaner) can only be operated when the filter pump is running and the pool/spa valves are in the pool-only position—the Pro Logic will keep the relay off until these other conditions are suitable for operation. If the Aux1 relay is on during the programmed off time, it may be because of freeze protection. Also, manual operation overrides the timeclock. Refer to page 12 for general notes regarding timeclock programming.

- |                      |   |
|----------------------|---|
| Aux1-CountDn<br>0:20 | +- Adjust time setting (Manual On/Off, 0:05, 0:10, 0:15...) |
|                      | <> Move to previous/next menu item                          |

This menu will appear only if the Aux1 is configured for countdown timer. This setting is the time after

you manually turn on the Aux1 relay until the Pro Logic automatically turns off the relay. You can also manually turn off the relay at an earlier time by pressing the AUX1 button.

*NOTE: The configurations for Valve3 and Valve4 are identical. However, if Heater2 was enabled, then the Valve4 configuration will not appear (a single relay is used to implement either the Heater2 function or the Valve4 function--it can not do both).*

- or
  - Valve3-all  
8:30A to 4:00P

+- Adjust time setting  
<> Move between start and stop times & to previous/next menu item
  - Valve3-wkend  
8:30A to 4:00P

+- Adjust time setting  
<> Move between start and stop times & to previous/next menu item
  - Valve3-wkday  
8:30A to 4:00P

+- Adjust time setting  
<> Move between start and stop times & to previous/next menu item

This menu will appear only if Valve3 is configured for timeclock. The valve will rotate on and off at the designated times.

- or
  - Valve3-CountDn  
0:20

+- Adjust time setting (Manual On/Off, 0:05, 0:10, 0:15...)  
<> Move to previous/next menu item

This menu will appear only if the valve3 is configured for countdown timer. This setting is the time after you manually turn on the valve3 relay until the Pro Logic automatically turns off the relay. You can also manually turn off the valve at an earlier time by pressing the VALVE3 button.

- Super Chlorinate  
24 hours

+- Adjust Superchlorination period (1 - 96 hours)  
<> Move to previous/next menu item

For larger pools or when you have an unusually high bather load, a large amount of rain, a cloudy water condition, or any other condition that requires a large amount of chlorine to be introduced to the pool, may require more hours of Superchlorination. Smaller pools require less hours of Superchlorination.

## Group Function

The Pro Logic offers the ability to assign a Group function to a particular button. Instead of a button controlling one particular function, the button can be programmed to initiate a sequence of commands that are programmed in the Configuration Menu. For example, instead of the Lights button turning on and off the pool light only, the button can be programmed to turn on the pool light, turn on the bug light, turn off the pool cleaner, turn on and dim the patio lights, turn on the music, etc. all at the same time. This convenient feature is offered on all Aux buttons, both Valve buttons and the Lights button. The Pro Logic can be programmed to control up to four groups. Refer to this section when programming Group commands.

Before assigning and configuring all the desired functions and their control parameters, the group itself must be configured. The options for controlling groups are Manual On/Off, Countdown Timer, and Timeclock. The group will turn on and off based on this selection.

When setting up a Group function in the Configuration Menu, the first menu allows you to select the control parameter (how the group is activated and de-activated) and the second menu allows you to select which Pro Logic functions are to be controlled in the group.

A table of functions and their corresponding control parameters are listed below.

Function	Control Parameter
Pool/Spa	Unaffected, Pool only, Spa only, or Spillover
Pool Filter	Unaffected, Off, On, High, Low, On (Lowest to Highest)
Lights <small>(standard relay)</small>	Unaffected, Off, or On
Lights <small>(dimmer relay)</small>	Unaffected, Off, On (100%, 80%, 60%, 40%, or 20%)
Lights <small>(VSP relay)</small>	Unaffected, Off or On (10% to 100%)
Spa Filter	Unaffected, Off, On, High, Low, On (Lowest to Highest)
Aux1-14 <small>(standard relay)</small>	Unaffected, Off or On
Aux1-14 <small>(dimmer relay)</small>	Unaffected, Off, On (100%, 80%, 60%, 40%, or 20%)
Aux1-14 <small>(VSP relay)</small>	Unaffected, Off or On (10% to 100%)
Valve3	Unaffected, Off or On
Valve4	Unaffected, Off or On
Spa Htr1 Set	Unaffected, Off, 65°-104°F
Pool Htr1 Set	Unaffected, Off, 65°-104°F
Spa Htr2 Set	Unaffected, Off, 65°-104°F
Pool Htr2 Set	Unaffected, Off, 65°-104°F
Spa Solar Set	Unaffected, Off, 65°-104°F
Pool Solar Set	Unaffected, Off, 65°-104°F
SuperChlr	Unaffected, Off, On

Note that all functions in the table may not be offered. The available functions are dependent on how the Pro Logic is configured. For example, if the Pro Logic is configured for a single heater, “Heater2” will not be available as an option in the Group menu. Also, under some circumstances, functions will be displayed but can’t be changed. Note that the function whose menu you are in, will not be displayed as an option and will automatically turn on when the group is activated. For example, if programming a Group function under the Lights menu, the Lights function will not be offered as an option and the Lights function will automatically turn on with the group.

The available control parameters vary with each function. All functions offer “Unaffected”, which should be selected if you do not wish to control that particular function within the group. All other parameters will depend on the particular function selected.

When activating Group functions, be aware that the most recent Group function that you activate will override any previous Group functions.

### **Heater Setpoints in Groups**

The Pro Logic can be programmed to use alternate heater setpoints (conventional and/or solar) while running group commands. This allows the heater to be set to a higher or lower temperature than normal, while the group is activated. When the group stops, the setpoint will return to its normal setting.

Changing the setpoint while the Group is running will make the Group release the alternate setpoint control and revert back to the normal heater setting. Any changes that are made at that point will affect the normal heater setting. The next time the Group is activated, the temperature will return to the group setpoint that was originally programmed in the Configuration Menu. To change the setpoint while the Group is running, go to the Settings menu and press the +/- button while “Group Control” is displayed. The setpoint will change and be retained as the new normal heater setpoint.

## Super Chlorinate

The Pro Logic can be programmed to Super Chlorinate the pool or spa while running a group command. When the Group starts, the Super Chlorinate cycle will begin. Super Chlorinate will continue until the preset time expires (see Timers Menu/Super Chlorinate Hours) or until the Group turns off. Changing the Super Chlorinate state using the Settings Menu, the Aqua Pod Super Chlorinate button, or a Super Chlorinate assigned Aux/Lights/Valve button will temporarily cancel the Group's control of Super Chlorinate until the next time the Group is activated.

## Variable Speed in Groups

The Pro Logic can be programmed to use alternate pump speeds while running group commands. This allows the pump(s) to be set to a higher or lower speed than normal, while the group is activated. When the group stops, the speed will return to its normal setting.

Changing the speed setting while the group is running will make the group release the alternate speed setting and revert back to the normal speed setting. Any changes that are made at that point will affect the normal speed setting. The next time the group is activated, the speed will return to the group speed setting that was originally programmed in the Configuration Menu. To change the speed setting while the group is running, go to the Settings menu and press the +/- button while "Group Control" is displayed. The speed setting will change to the normal speed setting.

## PS-8 and PS-16 Virtual Models

Pro Logic Virtual models are similar to standard PS models, but offer additional auxiliary outputs with limited functionality. The PL-PS-8-V is similar to the PL-PS-4 with 4 additional Aux outputs. The PL-PS-16-V is similar to the PL-PS-8 with 8 additional outputs. The additional aux outputs on virtual models can only be assigned to the Super Chlorinate function (if the Chlorinator is enabled) or to a Group function. Refer to the following programming information when assigning functions to the virtual auxiliary outputs.

## Configuration Menus

Each item needs to be programmed and may contain additional sub-menu items. Refer to the following pages for information on programming.

Chlor. Config. + to view/change	+ Push to access Chlorinator option <> Move to next configuration menu
Chlorinator Enabled	+/- Toggle between Chlorinator Enabled and Disabled (default) <> Move to next menu item
Display Salt	+/- Toggle between Display Salt (default) and Minerals <> Move to previous/next configuration menu
Cell Type T-CELL-15	+/- Rotates between available Cell types <> Move to next menu item

### Chlorinator

*Requires the use of a chlorinator cell and P-KIT sold separately.* If the chlorinator is enabled, then the cell and flow switch must also be installed and the Pro Logic will automatically chlorinate both the pool and spa according to the desired output setting (see Settings Menu in the Operation manual). If disabled (default), all displays relating to the chlorinator will be suppressed.

When the chlorinator is enabled, the Pro Logic will automatically detect and control any Aqua Rite(s) that is installed in the system.

### Display

Allows for the display of salt (default) or mineral values.

### Cell Type Selection

The Cell Type Menu appears after "Display Salt/Minerals" in the Chlorinator Configuration Menu. The options are T-CELL-15 (default), T-CELL-9, T-CELL-5 or T-CELL-3. Make the proper selection based on the chlorinator cell that is used in your system. Refer to the information below.

"T-CELL-3" = T-CELL-3, GLX-CELL-3-W  
"T-CELL-5" = GLX-CELL-5, GLX-CELL-5-W  
"T-CELL-9" = T-CELL-9, GLX-CELL-9-W  
"T-CELL-15" = T-CELL-15, GLX-CELL-15-W

Chemistry Config.  
Wizard + to enter

- + Press to access Chemistry Config. Wizard
- <> Move to previous/next menu item

### Chemistry Configuration Wizard

*Requires use of the optional AQL-CHEM Sensing Kit.* Following the steps of the Chemistry Config. Wizard will set up the AQL-CHEM to sense ORP and pH levels and, if the chlorination function is used, can configure the Pro Logic to generate the correct amount of chlorine to properly sanitize the pool. Refer to the AQL-CHEM manual for more detailed information.

Pool/Spa Config.  
+ to view/change

- + Push to access Pool/Spa options
- <> Move to previous/next configuration menu

Pool/Spa Setup  
Pool and Spa-Std

- + Rotates between Pool and Spa-Std (default), Pool and Spa-Dual, Pool Only, and Spa Only options
- <> Move to next menu item

*if "Pool and Spa-Dual" is selected*

Heaters  
Htr1 = Spa, Htr2 = Pool

- + Toggle between Htr1=Spa, Htr2=Pool (default) and Shared Heaters
- <> Move to next menu item

*if "Pool and Spa-Std" is selected*

Spa - CountDn  
00:30

- + Adjust time setting (Manual On/Off, 0:05, 0:10, 0:15..., (default is 4:00))
- <> Move to next menu item

*if "Pool and Spa-Std or Dual" is selected*

Spa Spillover  
Enabled

- + Toggle between Enabled and Disabled (default) Spa Spillover
- <> Move to next menu item or previous/next configuration menu

*if "Pool and Spa-Std or Dual" is selected and if "Spa Spillover" is enabled*

Filter Operation  
Spa Spillover

- + Toggle between Pool Only (default) and Spa Spillover options
- <> Move to previous/next configuration menu

*if "Pool Only" or "Spa Only" is selected*

V1=Aux1, V2=Aux2  
Disabled

- + Toggle between Enabled and Disabled (default)
- <> Move to previous/next configuration menu

*if "Pool and Spa-Std" is selected*

Filter Off Valve  
Change: Enabled

- + Toggle between Enabled (default) and Disabled
- <> Move to previous/next configuration menu

### Pool/Spa Setup

If "Pool Only" or "Spa Only" are selected, then the pool/spa valves are not needed and pushing the POOL/SPA button on the display/keypad will have no effect. If "Pool and Spa-Std" is selected, then the pool/spa suction and return valve actuators should be connected to the Pro Logic. Pressing the POOL/SPA button on the display/keypad will allow the homeowner to alternate between pool and spa operation. If "Pool and Spa-Dual" is selected, then only the Pool/Spa return valve actuator should be connected to the Pro Logic.

### Heaters

This menu will only appear if Pool/Spa setup is set to "Pool and Spa-Dual". This allows the heater(s) to either be shared between the pool and spa ("Shared" selected) or for Heater1 to be dedicated to the spa and Heater2 to be dedicated to the pool ("Htr1=Spa, Htr2=Pool" selected).

### Spa CountDn

This menu will appear only if Pool/Spa Setup is set to "Pool and Spa-Std". This setting is the time, after you manually switch the Pool/Spa valves to "Spa Only", until the Pro Logic automatically returns the valves to their previous positions. It is programmed in increments of 5 minutes, from "Manual On/Off" (0 minutes) to "21:00" (21 hours). The filter is forced on during this time period.

### Spa Spillover

When spa spillover is "Enabled" and "Pool and Spa-Std", the homeowner will be able to rotate through "Pool Only" (both suction and return valves switched to pool), "Spa Only" (both suction and return valves switched to spa) and "Spillover" (suction valve switched to pool and return valve switched to spa) by successive presses of the "Pool/Spa" button. For "Pool and Spa-Dual", only "Pool Only" and "Spillover" are available.

## Filter Operation

If “Spa Spillover” is selected, the Pro Logic will automatically switch the pool/spa suction and return valves to “spillover” at the start of the programmed pool filtering time period or when the super-chlorinate function is turned on. The valves will remain in this position for the remainder of the super-chlorinate period. This option is usually preferable because both the pool and spa water will be filtered and sanitized.

If “Pool Only” is selected, then the Pro Logic will switch the pool/spa valves to the “pool only” position at the start of the programmed pool filtering time period or when the super-chlorinate function is turned on. This may be desirable on some systems with in-floor cleaners because it allows the cleaner to operate all the time the pool is being filtered and/or the super chlorinate is running.

## V1=Aux1, V2=Aux2

This menu appears only if the Pool/Spa Setup is “Pool Only” or “Spa Only”. When enabled, Valve 1 (return) will follow the Aux1 output and Valve 2 (suction) will follow the Aux2 output. When disabled (default), the return and suction pool/spa valves function normally.

## Filter Off Valve Change

This menu appears only if Pool/Spa setup is set to “Pool and Spa”. When enabled (default), the filter pump will shut off for 35 seconds whenever the Pool/Spa valves are turning. The pump will NOT shut off when the heater has Cooldown enabled and is either on or in the Heater Cooldown mode.

Filter Config. + to view/change	+ Push to access pump options <> Move to previous/next configuration menu
Filter Name Pool Filter	+ Rotates between all available names <> Move to next menu item
Filter Pump 1 Speed	+ Rotates between 1-speed (default), 2-speed and variable speed options <> Move to next menu item
<i>if “Variable Speed” is selected</i> Lowest Speed 10%	+ Adjust the lowest speed desired for variable speed operation <> Move to next menu item
<i>if “Variable Speed” is selected</i> Highest Speed 100%	+ Adjust the highest speed desired for variable speed operation <> Move to next menu item
Flow Monitor Disabled	+ Toggle between Enabled and Disabled (default) Flow Monitor <> Move to next menu item
Freeze Protect Enabled	+ Toggle between Enabled (default) and Disabled Freeze Protection <> Move to next menu item or previous/next configuration menu
<i>if “Freeze Protect” is enabled and “2-speed Filter” is selected</i> Freeze Protect High Speed	+ Toggle between high speed (default) and low speed <> Move to next menu item
<i>if “Freeze Protect” is enabled and “Variable Speed” is selected</i> Freeze Protect Speed 50%	+ Select the desired Freeze Protection speed from Filter Lowest to Filter Highest speed <> Move to next menu item
<i>if “Freeze Protect” is enabled</i> Freeze Temp 38°F	+ Adjust the desired freeze protection temperature (33°F - 42°F) <> Move to next menu item
External Input Disabled	+ Toggle between Enabled and Disabled (default) <> Move to previous/next configuration menu

## Filter Name

The Pro Logic allows you to assign any one of a number of names (e.g. “Filter Pump, Pool Filter, Spa Filter, etc.) to the filter relay. This will make the Pro Logic more user friendly to the homeowner when they want to control the filter equipment. A sheet of small name labels is included with the Pro Logic main unit and each remote display/keypad so that appropriate pushbuttons can be labeled the same as the name that you have assigned.

### **Filter Pump**

For 2-speed pumps: When a 2-speed pump is configured, one of the AUX relays must also be configured to control the low speed motor winding on the pump. Refer to the appropriate sections in the Installation manual for specific information regarding the control logic for 2-speed and variable speed pump operation.

For the Hayward variable speed pump: The Filter relay is used to supply input power to the pump. The relay will be on when the filter pump output is on. When the filter pump output is off, the relay will be off. On, off and speed is controlled by commands sent to the pump.

### **Lowest Speed**

This is the lowest speed that the variable speed pump is allowed to run at. It is used as the lower limit in the Low Speed Settings Menu. Set lowest speed from 10% (default) to 50%.

### **Highest Speed**

This is the highest speed that the variable speed pump is allowed to run at. It is used as the upper limit in the High Speed Settings Menu. Also, this is the speed that the pump will run at during the first 3 minutes of operation anytime the pump has been off for more than 30 seconds. Set highest speed from 20% to 100% (default).

### **Flow Monitor**

This feature will help protect the filter pump from damage due to no flow. When used with a Hayward flow switch, the Pro Logic monitors the state of water flow when the filter pump is on. If no flow is detected for more than 15 minutes, the Pro Logic will shut down the pool pump and the “Check System” LED will indicate an error. The error will be cleared the next time the pump is turned on.

### **Freeze Protection**

Freeze protection is used to protect the pool and plumbed equipment against freeze damage. If freeze protection is enabled and the AIR temperature sensor falls below the freeze threshold (see below), the Pro Logic will turn on the filter pump to circulate the water. If “Pool and Spa” is selected in the Pool/Spa sub-menu (see page 18), the valves will also alternate between the pool and spa every 30 minutes and the filter pump will turn off while the valves are turning. The chlorinator will not operate if freeze protection is the only reason the pump is running.

### **Freeze Protection Speed**

This menu only appears if freeze protection is enabled and the pump is configured for 2-speed or variable speed pump operation. If the pump turns on due to freeze protection only, the pump will run at this speed.

2-Speed pumps: Select high (default) or low speed operation.

Variable Speed pumps: Select the desired speed (from Filter Lowest to Filter Highest speed).

### **Freeze Protection Temperature**

Select the temperature to be used for freeze protection. Temperature is adjustable from 33°F-42°F (1°C-6°C). 38°F (3°C) is default. This threshold will be used for all outputs that have freeze protection enabled.

### **External Input Interlock**

When enabled, the filter pump will be forced off when the external input is active. Note that freeze protection will have precedence over this feature.

*if "Pool & Spa Dual" is selected*

Spa Filter Config. + Push to access Spa Filter options  
+ to view/change <> Move to previous/next configuration menu item

Spa Filter Pump +-- Rotates between 1-speed (default), 2-speed and variable speed options  
1 Speed <> Move to next menu item

*if "Variable Speed" is selected*

Lowest Speed +-- Adjust the lowest speed desired for variable speed operation  
10% <> Move to next menu item

*if "Variable Speed" is selected*

Highest Speed +-- Adjust the highest speed desired for variable speed operation  
100% <> Move to next menu item

Freeze Protect +-- Toggle between Enabled (default) and Disabled Freeze Protection  
Enabled <> Move to next menu item or previous/next configuration menu

*if "Freeze Protect" is enabled  
and "2-speed Filter" is selected*

Freeze Protect +-- Toggle between high speed (default) and low speed  
High Speed <> Move to next menu item

*if "Freeze Protect" is enabled  
and "Variable Speed" is selected*

Freeze Protect Speed +-- Select the desired Freeze Protection speed from Spa Filter Lowest to Highest speed  
50% <> Move to next menu item

External Input +-- Toggle between Enabled and Disabled (default)  
Disabled <> Move to previous/next configuration menu

### Spa Filter Pump

For 2-speed pumps: When a 2-speed pump is configured, one of the AUX relays must also be configured to control the low speed motor winding on the pump. Refer to the appropriate sections in the Installation manual for specific information regarding the control logic for 2-speed and variable speed pump operation.

For the Hayward variable speed pump: The Spa Filter (Aux1) relay is used to supply input power to the pump. The relay will be on when the filter pump output is on. When the filter pump output is off, the relay will be off. On, Off and speed is controlled by commands sent to the pump.

### Lowest Speed

This is the lowest speed that the variable speed pump is allowed to run at. It is used as the lower limit in the Spa Low Speed Settings Menu. Set lowest speed from 10% (default) to 50%.

### Highest Speed

This is the highest speed that the variable speed pump is allowed to run at. It is used as the upper limit in the Spa High Speed Settings Menu. Also, this is the speed that the pump will run during the first 3 minutes of operation anytime the pump has been off for more than 30 seconds. Set highest speed from 20% to 100% (default).

### Freeze Protection

Freeze protection is used to protect the spa and plumbed equipment against freeze damage. If freeze protection is enabled and the AIR temperature sensor falls below the freeze threshold (selectable in Filter Configuration Menu - page 20), the Pro Logic will turn on the spa filter pump to circulate the water.

### Freeze Protection Speed

This menu only appears if freeze protection is enabled and the pump is configured for 2-speed or variable speed pump operation. If the pump turns on due to freeze protection only, the pump will run at this speed.

2-Speed pumps: Select high (default) or low speed operation.

Variable Speed pumps: Select the desired speed (from Filter Lowest to Filter Highest speed).

### External Input

When enabled, the filter pump will be forced off when the external input is active. Note that freeze protection will have precedence over this feature.



NOTE: Heater1 and Heater2 configuration are identical. If Heater2 is enabled then Valve4 will automatically be disabled due to the fact that they use the same output relay and only 1 function can be assigned to that relay.

Heater1 Config. + to view/change	+ Push to access heater options <> Move to previous/next configuration menu
Heater1 Disable	+- Toggle between Enabled and Disabled (default) Heater 1 <> Move to next menu item or previous/next configuration menu
<i>if "Heater1" is enabled</i> Heater1 Name Gas Heater	+- Rotates between all available names <> Move to next menu item
<i>if "Heater1" is enabled</i> Heater1 Cooldown Disabled	+- Toggle between Enabled and Disabled (default) Heater 1 Cooldown <> Move to next menu item
<i>if "Heater1" is enabled</i> Heater1 Extend Disabled	+- Toggle between Enabled and Disabled (default) Heater 1 Extend <> Move to previous/next configuration menu
<i>if "Heater1" is enabled and 2-speed filter pump is selected</i> Allow Low Speed Disabled	+- Toggle between Enabled and Disabled (default) <> Move to next menu item or previous/next configuration menu
<i>if "Heater1" is enabled and variable speed filter pump is selected</i> Minimum Speed 50%	+- Select the desired minimum filter pump speed for Heater 1 (Filter Lowest to Highest) <> Move to next menu item or previous/next configuration menu
<i>display for Heater2 if "Heater2" is enabled</i> Heater2 is Heatpump No	+- Toggle between Enabled and Disabled (default) <> Move to previous/next configuration menu

### Heater1

If the heater is “Enabled”, the heater relay will turn on when the water temperature is less than the desired temperature setting and the filter pump is running. The desired temperature is in the “Settings Menu”. If applicable, the homeowner will be prompted to enter separate “pool” and “spa” settings. Depending on the position of the pool/spa suction valves, the proper temperature setting will be used.

### Heater Name

The Pro Logic allows you to assign any one of a number of names (e.g. “Gas Heater, Heat Pump, etc.) to each of the heater control functions. This will make the Pro Logic much more user friendly to the homeowner when they want to turn various heaters on or off or set temperatures. A sheet of small name labels is included with the Pro Logic main unit and each remote display/keypad so that appropriate pushbuttons can be labeled the same as the name that you have assigned.

### Heater Cooldown

This feature ensures that the heater cools down before water circulation is stopped. When enabled, the Pro Logic will continue to run the filter pump for 5 minutes after the heater turns off. During this period the filter pump LED will flash and also a “Heater Cooldown, X:XX remaining” message will scroll on the display.

When the filter pump is running and the heater is on: Pressing the “Filter” button once will cause the heater to turn off, but the filter pump will continue to run for heater cooldown (filter LED flashing and message on display). Pushing the filter button a second time will override the heater cooldown operation and turn the filter pump off.

For a Pool/Spa Setup selection of “Pool Only”, “Spa Only” or “Pool and Spa-Std”, Heater1 and/or Heater2 cooldown affect the filter pump. For “Pool and Spa-Dual”, Heater1 is associated with the spa filter and Heater2 with the pool filter.

### Heater Extend

If “Enabled”, the filter extend logic keeps the filter pump running beyond the normal turn-off time until the pool (or spa) is heated up to the desired temperature setting (see Settings Menu). Heater extend will NOT cause the filter pump to turn on, it will only delay the turn off time when the heater is operating.

For a Pool/Spa Setup selection of “Pool Only”, “Spa Only” or “Pool and Spa-Std”, Heater1 and/or Heater2 will keep the filter pump running. For “Pool and Spa-Dual”, Heater1 will keep the spa filter running and Heater2 will keep the pool filter running.

### Allow Low Speed

This menu only appears if the filter is configured for 2-speed operation. During default operation, high speed mode is used whenever the heater is on. If Allow Low Speed is enabled, low speed will be allowed even if the heater is on.

### Minimum Speed

This menu only appears if the filter is configured for variable speed operation. This is the minimum speed the pump will run at when the heater is on. The selection is from Filter Lowest to Filter Highest speed.

### Heater2 is Heatpump

This menu appears in the Heater2 configuration menu if Heater2 is enabled. If set to “Yes”, Heater2 will only be allowed to be on if the Air Temperature is  $\geq 50^{\circ}\text{F}$ . Also, two new menus, Spa Heater2 Priority and Pool Heater2 Priority, will appear in the Settings Menu. Refer to the Settings Menu for more information on these new menus.

Solar Config. + to view/change	+ Push to access solar options <> Move to previous/next configuration menu
Solar Disabled	+ - Toggle between Enabled and Disabled (default) Solar <> Move to next menu item or previous/next configuration menu
<i>if “Solar” is enabled</i> Solar-Extend Disabled	+ - Toggle between Enabled and Disabled (default) Solar Extend <> Move to next menu item
<i>if “Solar” is enabled</i> Solar Priority Disabled	+ - Toggle between Enabled and Disabled (default) Solar Priority <> Move to next menu item
<i>if “Solar” is enabled and “2-speed Filter” is selected</i> Allow Low Speed Disabled	+ - Toggle between Enabled and Disabled (default) <> Move to next menu item or previous/next configuration menu

### Solar

The Solar configuration menu will **NOT** appear if “Pool and Spa - Dual” has been selected in the Pool/Spa setup menu. If the solar control logic is “Enabled”, several additional steps must be taken to ensure proper operation of the solar heating system. If the solar is operated by a valve, then a valve (Valve3 or Valve4) output must be setup for solar logic (page 29). If the solar is operated by a pump, then one of the AUX relays must be set up for solar logic (page 27). Also, the “solar” temperature sensor must be installed. This sensor is typically mounted near the collector array and is used to sense whether sufficient solar heat is available.

If solar is “Enabled”, the valve or solar pump relay will turn on when the water temperature is less than the desired temperature setting AND the solar sensor is hotter than the water by at least 8°F. The desired temperature is in the “Settings Menu”. If applicable, the homeowner will be prompted to enter separate pool and spa desired temperature settings. Depending on the position of the pool/spa suction valve, the proper temperature setting will be used.

### Solar Extend

If “Enabled”, the filter extend logic keeps the filter pump running beyond the normal turn-off time if solar heat is still available. When solar heat is no longer available, both the solar valve/pump and filter pump will turn off simultaneously. Solar extend will NOT cause the filter pump to turn on, it will only delay the turn off time when solar is operating.

### Solar Priority

If both “Solar Control” and “Heater Control” are enabled, the Solar Priority feature will keep the conventional heater off whenever solar heat is available. This provides the most cost effective way of heating the pool. When solar heat is not available, the conventional heater will operate normally.

### Allow Low Speed

This menu only appears if the pool filter is configured for 2-speed operation. During default operation, high speed mode is used whenever the solar heater is on. If Allow Low Speed is enabled, low speed pump operation will be allowed during solar heating except for the first 3 minutes after solar heat turns on.

only if optional ColorLogic Network  
Module is detected at power up

- ColorLogic Config. + Push to activate ColorLogic options  
+ to view/change <> Move to previous/next configuration menu

### ColorLogic Config.

This menu appears if the optional ColorLogic Network Module is installed and detected at power up. Refer to the AQL-COLOR-MODHV manual for detailed installation and operation instructions.

- External Input +-- Toggle between Open and Closed (default)  
Active Closed <> Move to next menu item or previous/next configuration menu

### External Input

The external input device can either be normally open or normally closed. In this menu, select the state of the external input device when active. For example, if the switch is normally open and closes when active, set External Input to “Active Closed”.

*NOTE: If an AQL-COLOR-MODHV ColorLogic Network Module is detected at startup, only the Lights Name menu will appear under Lights Configuration. Refer to the AQL-COLOR-MODHV manual for more information.*

- Lights Config. + Push to access Lights options  
+ to view/change <> Move to previous/next configuration menu
- Lights Name +-- Rotates between all available names  
Pool Light <> Move to next menu item or previous/next configuration menu
- Lights Function +-- Rotates between Manual On/Off (default), Countdown Timer, Low Speed- Filter,  
Manual On/Off Timeclock, Solar, Low Speed-Spa Filter, Group, Super Chlorinate, and pH Dispense  
<> Move to next menu item

*for manual on/off, countdown timer and timeclock functions*

- Lights Relay +-- Toggle between Standard (default), Dimmer and VSP  
Standard <> Move to next menu item or previous/next configuration menu

*for all functions except solar, dimmer relay, super chlorinate pH dispense, low speed, and group*

- Lights Interlock +-- Toggle between Enabled and Disabled (default) Lights Interlock  
Disable <> Move to next menu item

*for group function only*

- Lights Group +-- Rotates between Manual On/Off (default), Countdown Timer and Timeclock  
Timer: None(Manual) <> Move to next menu item

*for group function only*

- Lights Group +-- Options available depend on the function that is selected  
Filter: Unaffected <> Move to previous/next menu item or next configuration menu

*for all functions except solar, dimmer relay, super chlorinate pH dispense, low speed, and group*

- Lights Ext Input +-- Toggle between Enabled and Disabled (default)  
Disabled <> Move to previous/next configuration menu

*for all functions except dimmer relay, super chlorinate pH dispense, low speed, and group*

- Lights Freeze +-- Toggle between Enabled and Disabled (default) Lights Freeze  
Disable <> Move to previous/next configuration menu

*if filter pump is set to variable speed and the relay type is set to standard*

- Lights Pump Spd +-- Select Settings Menu (default) or desired pump speed (Filter Lowest to Highest)  
Settings Menu <> Move to previous/next configuration menu

### Lights Name

The Pro Logic allows you to assign any one of a number of names (e.g. “Pool Light, Spa Light, Deck Light, etc.) to this control function. Note that other lights may be assigned to other Aux outputs. This will make the Pro Logic much more user friendly to the homeowner when they want to turn various lights on or off. A sheet of small name labels is included with the Pro Logic main unit and each remote display/keypad so that the “Lights” pushbutton can be labeled the same as the name that you have assigned. At this time it is also a good idea to make sure that the relay in the control box is also labeled (hand written) with the same name as a help to technicians who may service this system at a later date.

### Lights Function

Although designated as the “Lights” output, the function of the lights relay is similar to the Aux relays. If pool lights are wired to the lights relay, some options including Solar function, Low Speed of a 2-Speed Filter Pump, Lights Interlock and Lights Freeze Protection are not applicable and should

be disabled. If no pool lights are used, the lights relay can be used to control other pool devices that may require these options. The function of each option is shown below.

*Manual On/Off*—the lights relay will alternate between turning on and off when the LIGHTS button is pressed. There is no automatic control logic.

*Countdown Timer*—the lights relay will turn on when the LIGHTS button is pressed. The lights relay will turn off automatically after a programmed time (see Timers Menu). The LIGHTS button can also be used to turn the output off.

*Low Speed of a 2-speed Filter Pump* – the Pro Logic will turn on the lights relay whenever the low speed operation of the filter pump is required. It is very important that the “2-speed” filter pump option be selected under the “Filter Config.” Menu for proper operation.

*Timeclock* – the lights relay will turn-on and turn-off at the times set for the lights timeclock in the Settings Menu (see Settings Menu). The LIGHTS button can also be used to turn the output on and off.

*Solar* – the lights relay can operate a solar booster pump which will turn on when the filter pump is running and solar heat is available and the water is less than the desired temperature setting. Note that “Solar” must be enabled in the “Solar Config.” menu for proper operation to occur.

*Low Speed of a 2-Speed Spa Filter Pump* – the Pro Logic will turn on the lights relay whenever the low speed operation of the Dual Equipment Spa filter pump is required. “Pool and Spa-Dual” (located in Pool/Spa Setup menu) and “2-Speed” (located in Spa Filter Config. menu) must be selected for proper operation.

*Group* – the lights relay operates when the Group function is initiated and shuts off when the Group function is terminated. See Lights Group section for operation information for the Group function.

*Super Chlorinate* – The Super Chlorinate function can be assigned to any Aux, Lights or Valve button. This allows the user to simply hit a button to start a Super Chlorinate cycle, rather than using the Settings Menu. Note that only one button can be assigned to this function.

*pH Dispense* –When Chemistry Sensing is enabled and pH Reduction Control is NOT disabled, the Pro Logic will turn on the Lights relay when there is a need to energize the pH dispensing device. The pH Dispense function can be assigned to any Aux or the Lights output. Once programmed for pH Dispense, the Lights button will have no function. Requires the use of the AQL-CHEM sensing kit.

### **Lights Relay**

This feature allows the user to select either “Standard” (default), “Dimmer” or “VSP” type relay for the Lights output. The optional AQL-DIM dimmer kit must be installed if “Dimmer” is desired.

When “Dimmer” is selected, and the Lights output is manually turned on, the “+” and “-” buttons adjust the level from 20% to 100% (default). The level is saved for the next time the lights are turned from off to on.

If “VSP” is selected, the Lights relay is used to supply power to a Hayward Variable Speed Pump (VSP). The relay will be on when the Lights output is on and off when the output is off. On, off and speed are controlled by commands sent to the VSP. Note: Up to 6 Lights/Aux outputs can be configured as VSP relays.

### **Lights Interlock**

If enabled, this feature will override the function (Manual On/Off, Countdown Timer, Timeclock) selected above and turn the lights relay off when: filter pump is off, first 3 minutes of filter pump operation (allows the pump to prime and get water flowing), when the pool/spa suction return valves are in any position other than “pool only”, or for the first 3 minutes after solar turns on (allows air in the solar panels to be purged). Interlock is not available for solar, low speed filter pump, dimmer, group, super chlorinate, or pH dispense functions.

### **Lights Group**

The Lights Group function allows the user to perform multiple tasks with a single push of the “Lights” button. When setting up a Group function, refer to page 15 for specific programming information. There are two Group menus; the first menu determines how the group command will be initiated (Manual On/Off, Countdown Timer, or Timeclock) and the second menu selects the desired functions and their respective control parameters.

When activating Group functions, be aware that the most recent Group function that is initiated will override any previous Group function.

### Lights External Input Interlock

When Lights External Input Interlock is enabled, the lights output will be forced off when the external input is active. This will have precedence over freeze protection. Lights External Input Interlock is not available for solar, low speed filter pump, dimmer, group, super chlorinate, or pH dispense functions.

### Lights Freeze Protection

This function helps protect equipment that is wired to the lights relay against freeze damage. If Freeze Protection is enabled and the AIR temperature sensor falls below the selected freeze temperature threshold, the Pro Logic will energize the lights relay. **IMPORTANT:** this only enables operation of the lights relay during freeze--see the "Filter Pump Config." menu to enable freeze protection for the main circulation system. Freeze Protection is not available for low speed filter pump, dimmer, group, super chlorinate or pH dispense functions.

### Lights Pump Speed

This is the speed of the filter pump when the Lights output is on. The default selection is "Settings Menu". This is the speed of the pump that has been selected in the Settings Menu for normal filter operation. If an alternate speed is desired when the Lights output is on, push "+" or "-" and select from "Filter Lowest" to "Filter Highest" in 5% increments.

*NOTE: The configuration parameters for all Aux outputs are the same as shown below for Aux1. PS-4: Aux1 and Aux2. PS-8: Aux1 through Aux6. PS-16: Aux1 through Aux14. Also note that for the PS-16, Valves 7, 8, 9 and 10 are turned On/Off with the control function selected for Aux7, 8, 9, and 10, respectively.*

<div style="border: 1px solid black; padding: 2px; display: inline-block;">Aux1 Config. + to view/change</div>	<b>+</b> Push to access Aux options <b>&lt;&gt;</b> Move to previous/next configuration menu
<div style="border: 1px solid black; padding: 2px; display: inline-block;">Aux1 Name Cleaner</div>	<b>+ -</b> Rotates between all available names <b>&lt;&gt;</b> Move to next menu item
<div style="border: 1px solid black; padding: 2px; display: inline-block;">Aux1 Function Manual On/Off</div>	<b>+ -</b> Rotates between Manual On/Off (default), Countdown Timer, Low Speed- Filter, Timeclock, Solar, Low Speed-Spa Filter, Group, Super Chlorinate, and pH Dispense <b>&lt;&gt;</b> Move to next menu item
<i>for manual on/off, countdown timer and timeclock functions</i>	
<div style="border: 1px solid black; padding: 2px; display: inline-block;">Aux1 Relay Standard</div>	<b>+ -</b> Toggle between Standard (default), Dimmer, ColorLogic and VSP <b>&lt;&gt;</b> Move to next menu item or previous/next configuration menu
<i>for all functions except solar, dimmer relay, super chlorinate low speed, group and pH dispense</i>	
<div style="border: 1px solid black; padding: 2px; display: inline-block;">Aux1 Interlock Disable</div>	<b>+ -</b> Toggle between Enabled and Disabled (default) Aux1 Interlock <b>&lt;&gt;</b> Move to next menu item
<i>for group function only</i>	
<div style="border: 1px solid black; padding: 2px; display: inline-block;">Aux1 Group Timer: None(Manual)</div>	<b>+ -</b> Rotates between Manual On/Off (default), Countdown Timer and Timeclock <b>&lt;&gt;</b> Move to next configuration menu item
<i>for group function only</i>	
<div style="border: 1px solid black; padding: 2px; display: inline-block;">Aux1 Group Filter: Unaffected</div>	<b>+ -</b> Options available depend on the function that is selected <b>&lt;&gt;</b> Move to previous/next menu item or next configuration menu
<i>for all functions except solar, dimmer relay, super chlorinate low speed, group and pH dispense</i>	
<div style="border: 1px solid black; padding: 2px; display: inline-block;">Aux1 Ext Input Disabled</div>	<b>+ -</b> Toggle between Enabled and Disabled (default) <b>&lt;&gt;</b> Move to previous/next configuration menu
<i>for all functions except dimmer relay, super chlorinate low speed, group and pH dispense</i>	
<div style="border: 1px solid black; padding: 2px; display: inline-block;">Aux1 Freeze Disable</div>	<b>+ -</b> Toggle between Enabled (default) and Disabled Aux1 Freeze <b>&lt;&gt;</b> Move to previous/next configuration menu
<i>if filter pump is set to variable speed and the relay type is set to standard</i>	
<div style="border: 1px solid black; padding: 2px; display: inline-block;">Aux1 Pump Spd Settings Menu</div>	<b>+ -</b> Select Settings Menu (default) or desired pump speed (Filter Lowest to Highest) <b>&lt;&gt;</b> Move to previous/next configuration menu

**⚠ WARNING: Do not use the Pro Logic to control an automatic pool cover. Swimmers may become entrapped underneath the cover.**

*NOTE: If "Pool and Spa-Dual" is selected, Aux1 is dedicated to use as the spa filter. Its Name is set to Spa Filter; the Function is set to Timeclock and Interlock is set to Disabled. These can't be changed.*

### Aux1 Name

The Pro Logic allows you to assign any one of a number of names (e.g. "Cleaner Pump, Waterfall, Gazebo Light, etc.) to each of the aux outputs control function. This will make the Pro Logic much

more user friendly to the homeowner when they want to turn various aux equipment on or off or program the timeclocks. A sheet of small name labels is included with the Pro Logic main unit and each remote display/keypad so that the “Aux” pushbutton can be labeled the same as the name that you have assigned. At this time it is also a good idea to make sure that the relay in the control box is also labeled (hand written) with the same name as a help to technicians who may service this system at a later date.

### **Aux1 Function**

*Manual On/Off (default)*—the aux relay will alternate between turning on and off when the aux button is pressed. There is no automatic control logic.

*Countdown Timer* – the aux relay will turn on when the AUX button is pressed and then will turn off automatically after a programmed time (see Timers Menu in the Operations Manual). The AUX button can also be used to turn the output off.

*Low Speed of a 2-speed Filter Pump* – the Pro Logic will operate the aux relay whenever the low speed operation of the filter pump is required. It is very important that the “2-speed” filter pump option be selected under the “Filter Config.” Menu for proper operation.

*Timeclock* – the aux relay will turn-on and turn-off at the times set for the aux timeclock in the Timers Menu (see Operations Manual). The AUX button can also be used to turn the output on and off.

*Solar* – the aux relay operates a solar booster pump which will turn on when the filter pump is running and solar heat is available and the water is less than the desired temperature setting. It is important to note that “Solar” must be enabled in the “Solar Config.” menu for proper operation to occur.

*Low Speed of a 2-Speed Spa Filter Pump* – the Pro Logic will turn on the aux relay whenever the low speed operation of the Dual Equipment Spa filter pump is required. “Pool and Spa-Dual” (located in Pool/Spa Setup menu) and “2-Speed” (located in Spa Filter Config. menu) must be selected for proper operation.

*Group* – the aux relay operates when the Group function is initiated and shuts off when the Group function is terminated. See Aux1 Group section for operation information for the Group function.

*Super Chlorinate* – The Super Chlorinate function can be assigned to any Aux, Lights or Valve button. This allows the user to simply hit a button to start a Super Chlorinate cycle, rather than using the Settings Menu. Note that only one button can be assigned to this function.

*pH Dispense* – When Chemistry Sensing is enabled and pH Reduction Control is NOT disabled, the Pro Logic will turn on the Aux relay when there is a need to energize the pH dispensing device. The pH Dispense function can be assigned to any Aux or the Lights output. Once programmed for pH Dispense, the Aux button will have no function. Requires the use of the AQL-CHEM sensing kit.

### **Aux1 Relay**

This feature allows the user to select either “Standard” (default), “Dimmer”, “ColorLogic” or “VSP” type relay for the Aux1 output. The optional AQL-DIM dimmer kit must be installed if “Dimmer” is desired. The AQL-COLOR-MODHV ColorLogic Network Module must be installed if “ColorLogic” is desired.

When “Dimmer” is selected, and the Aux1 output is manually turned on, the “+” and “-” buttons adjust the level from 20% to 100% (default). The level is saved for the next time the aux1 output is turned from off to on.

If “ColorLogic” is selected (Network Module must be detected at startup for this option to appear), additional menus will prompt you for configuration information. Refer to the AQL-COLOR-MODHV manual for details on how to configure an Aux output for use with Generation 3 or later ColorLogic lights.

If “VSP” is selected, the Aux relay is used to supply power to a Hayward Variable Speed Pump (VSP). The relay will be on when the Aux output is on and off when the output is off. On, off and speed are controlled by commands sent to the VSP. Note: Up to 6 Lights/Aux outputs can be configured as VSP relays.

### **Aux1 Interlock**

If “Enabled”, this feature will override the function (Manual On/Off, Countdown Timer, Timeclock), selected above and turn the aux1 off when: filter pump is off, first 3 minutes of filter pump operation (allows the pump to prime and get water flowing), when the pool/spa suction return valves are in any position other than “pool only”, or for the first 3 minutes after solar turns on (allows air in the solar panels to be purged). Interlock is not available for solar, low speed filter pump, dimmer, group, super chlorinate or pH dispense functions.

### Aux1 Group

The Aux1 Group function allows the user to perform multiple tasks with a single push of the “Aux1” button. When setting up a Group function, refer to page 15 for specific programming information. There are two Group menus; the first menu determines how the group command will be initiated (Manual On/Off, Countdown Timer, or Timeclock) and the second menu selects the desired functions and their respective control parameters.

When activating Group functions, be aware that the most recent Group function that is initiated will override any previous Group function.

### Aux1 External Input Interlock

When Aux1 External Input Interlock is enabled, the Aux1 output will be forced off when the external input is active. This will have precedence over freeze protection. Aux1 External Input Interlock is not available for solar, low speed filter pump, dimmer, group, super chlorinate, or pH dispense functions.

### Aux1 Freeze Protection

This function protects the pool, plumbing, and equipment against freeze damage. If Freeze Protection is enabled and the AIR temperature sensor falls below the selected freeze protection temperature, the Pro Logic will turn on the aux relay to circulate the water. **IMPORTANT:** this only enables operation of the AUX output during freeze--see the “Filter Pump Config.” menu to enable freeze protection for the main circulation system. Freeze Protection is not available for low speed filter pump, dimmer, group, super chlorinate or pH dispense functions.

### Aux1 Pump Speed

This is the speed of the filter pump when the Aux1 output is on. The default selection is “Settings Menu”. This is the speed of the pump that has been selected in the Settings Menu for normal filter operation. If an alternate speed is desired when the Aux1 output is on, push “+” or “-” and select from “Lowest” to “Highest” in 5% increments.

**PL-PS-8-V models only: Aux3 - Aux7 only**

**PL-PS-16-V models only: Aux7 - Aux14 only**

Aux7 Config. + to view/change	+ Push to access Virtual Aux options <> Move to previous/next configuration menu
Aux7 Name Cleaner	+ - Rotates between all available names <> Move to next menu item
Aux7 Relay Standard	+ - Toggle between Standard (default) and ColorLogic (must be detected) <> Move to next menu item or previous/next configuration menu
Aux7 Function Group	+ - Rotates between Super Chlorinate, Group and Manual On/Off <> Move to next menu item
Aux7 Group Timer: None(Manual)	+ - Rotates between Manual On/Off (default), Countdown Timer and Timeclock <> Move to next configuration menu item
Aux7 Group Filter: Unaffected	+ - Options available depend on the function that is selected <> Move to previous/next menu item or next configuration menu

For more information on the Group function, refer to page 15. If neither Super Chlorinate, ColorLogic or a Group can be assigned to a Virtual Aux button, the following will be displayed:

No Virtual  
Functions Available

*NOTE: The configuration for Valve3 and Valve4 are identical. However, if Heater2 was enabled, then the Valve4 configuration will not appear (a single relay is used to implement either the Heater2 function or the Valve4 function--it can not do both). For PS-16, see aux logic on page 27 for control of Valves7, 8, 9 and 10.*

Valve3 Config. + to view/change	<ul style="list-style-type: none"> <li>+ Push to access Valve3 options</li> <li>&lt;&gt; Move to previous/next configuration menu</li> </ul>
Valve3 Name Waterfall	<ul style="list-style-type: none"> <li>+ - Rotates between all available names</li> <li>&lt;&gt; Move to next menu item</li> </ul>
Valve3 Function Solar	<ul style="list-style-type: none"> <li>+ - Rotates between Manual On/Off (default), Countdown Timer, Timeclock, Solar, In-floor Cleaner, Group, and Super Chlorinate</li> <li>&lt;&gt; Move to next menu item</li> </ul>
<i>for all functions except solar, group or super chlorinate</i>	
Valve3 Interlock Disabled	<ul style="list-style-type: none"> <li>+ - Toggle between Enabled and Disabled (default) Valve3 Interlock</li> <li>&lt;&gt; Move to next menu item</li> </ul>
<i>for group function only</i>	
Valve3 Group Timer: None(Manual)	<ul style="list-style-type: none"> <li>+ - Rotates between Manual On/Off (default), Countdown Timer and Timeclock</li> <li>&lt;&gt; Move to next menu item</li> </ul>
<i>for group function only</i>	
Valve3 Group Filter: Unaffected	<ul style="list-style-type: none"> <li>+ - Options available depend on the function that is selected</li> <li>&lt;&gt; Move to previous/next menu item or next configuration menu</li> </ul>
<i>for all functions except solar, group or super chlorinate</i>	
Valve3 Ext Input Disabled	<ul style="list-style-type: none"> <li>+ - Toggle between Enabled and Disabled (default)</li> <li>&lt;&gt; Move to previous/next configuration menu</li> </ul>
<i>for all functions except group and super chlorinate</i>	
Valve3 Freeze Disabled	<ul style="list-style-type: none"> <li>+ - Toggle between Enabled and Disabled (default) Valve3 Freeze</li> <li>&lt;&gt; Move to previous/next configuration menu</li> </ul>
<i>if filter pump is set to variable speed and the relay type is set to standard</i>	
Valve3 Pump Spd Settings Menu	<ul style="list-style-type: none"> <li>+ - Select Settings Menu (default) or desired pump speed (Filter Lowest to Highest)</li> <li>&lt;&gt; Move to previous/next configuration menu</li> </ul>

### Valve3 Name

The Pro Logic allows you to assign any one of a number of names (e.g. “Cleaner Valve, Waterfall valve, Solar Valve, etc.) to each of the valve output control function. This will make the Pro Logic much more user friendly to the homeowner when they want to turn various valves on or off or program the timeclocks. A sheet of small name labels is included with the Pro Logic main unit and each remote display/keypad so that the “Valve3” (and “Valve4”) pushbutton can be labeled the same as the name that you have assigned.

### Valve3 Function

*Manual On/Off (default)* – the valve3 relay will alternate between turning on and off when the VALVE3 button is pressed. There is no automatic control logic. The VALVE3 button can also be used to turn the valve output on or off.

*Countdown Timer* – the valve3 relay will turn on when the VALVE3 button is pressed and then will turn off automatically after a programmed time (see Timers Menu in the Operations Manual). The VALVE3 button can also be used to turn the output off.

*Timeclock* – the valve turns on/off at the times set for the valve3 timeclock in the Timers Menu (see Operations Manual). The valve3 button can also be used to turn the valve output on or off.

*Solar* – the valve operates when the filter pump is running and solar heat is available and the water is less than the desired temperature setting. Solar heating must be enabled in the “Solar Config. menu for proper operation to occur.

*In-Floor Cleaner* – the valve switches the water returning to the pool between the in-floor cleaner and the normal return jets which facilitate efficient surface skimming. The valve will operate the in-floor cleaner for the first half of each clock hour and then switch to the jets/skimming for the last half of the hour.

*Group* – the valve operates when the Group function is initiated and shuts off when the Group



function is terminated. See valve3 Group section for operation information for the Group function.

*Super Chlorinate* – The Super Chlorinate function can be assigned to any Aux, Lights or Valve button. This allows the user to simply hit a button to start a Super Chlorinate cycle, rather than using the Settings Menu. Note that only one button can be assigned to this function.

### Valve3 Interlock

If “Enabled”, this feature will override the function (timeclock, manual on/off, countdown timer or in-floor cleaner) selected above and turn the valve off whenever the filter pump is off or the pool/spa suction/return valves are set to “spa only” or “spillover” operation. Interlock is not available with solar, group or super chlorinate.

### Valve3 Group

The valve3 Group function allows the user to perform multiple tasks with a single push of the VALVE3 button. When setting up a Group function, refer to page 15 for specific programming information. There are two Group menus; the first menu determines how the group command will be initiated (Manual On/Off, Countdown Timer, or Timeclock) and the second menu selects the desired functions and their respective control parameters.

When activating Group functions, be aware that the most recent Group function that is initiated will override any previous Group function.

### Valve3 External Input Interlock

When Valve3 External Input Interlock is enabled, the Valve3 output will be forced off when the external input is active. This will have precedence over freeze protection. Valve3 External Input Interlock is not available for solar, group, and super chlorinate.

### Valve3 Freeze Protection

This function protects the pool and plumbed equipment against freeze damage. If Freeze Protection is enabled and the AIR temperature falls sensor falls below the selected freeze protection temperature, the Pro Logic will turn on the valve to allow circulation of the water. IMPORTANT: this only enables operation of the valve3 output during freeze--see the “Filter Pump Config.” menu to enable freeze protection for the main circulation system. Freeze protection is not available for group or super chlorinate functions.

### Valve3 Pump Speed

This is the speed of the pump when the Valve3 output is on. The default selection is “Settings Menu”. This is the speed of the pump that has been selected in the Settings Menu for normal filter operation. If an alternate speed is desired when the Valve3 output is on, push “+” or “-” and select from “Filter Lowest” to “Filter Highest” in 5% increments.

*if AQL-SS-6B is connected*

6B Spa Config.  
+ to view/change

- + Push to access the 6 Button Spa Side Remote options
- <> Move to previous/next configuration menu

Select 6B Spa  
A

- + - Rotates between all available remotes
- <> Move to next menu item

6B A, Button 1  
Pool/Spa

- + - Rotates between System Off, Pool/Spa, Filter, Lights, Heater1, Valve3, Valve4, and all available Aux outputs
- <> Move to previous/next menu item or next configuration menu

### Select 6B Spa

This menu only appears if more than one AQL-SS-6B is detected at power up. Select which of the available remote controls (A, B or C) is to be configured.

### 6B A, Button 1

This menu allows the user to map each button of the AQL-SS-6B to one of the standard Pro Logic functions. The default selections are: Button 1 - Pool/Spa, Button 2 - Filter, Button 3 - Lights, Button 4 - Heater1, Button 5 - Aux1 and Button 6 - Aux2.

*if AQL-SS-D is connected*

Digital Spa Config.  
+ to view/change

- + Push to access the Digital Spa Side Remote options
- <> Move to previous/next configuration menu

Select Digital Spa  
A

- + - Rotates between all available remotes
- <> Move to next menu item

Digital A, Button 1  
Pool/Spa

- + - Rotates between System Off, Pool/Spa, Filter, Lights, Heater1, Valve3, Valve4, and all available Aux outputs
- <> Move to previous/next menu item

Digital A, Setpoint  
Heater1

- + - Rotates between heaters that are enabled
- <> Move to previous menu item or next configuration menu

**Select Digital Spa**

This menu only appears if more than one AQL-SS-D is detected at power up. Select which of the available remote controls (A, B or C) is to be configured.

**Digital A, Button 1**

This menu allows the user to map each button of the AQL-SS-D to one of the standard Pro Logic functions. The default selections are: Button 1 - Pool/Spa, Button 2 - Filter, Button 3 - Lights, Button 4 - Heater1, Button 5 - Valve3, Button 6 - Valve4, Button 7 - Aux1 and Button 8 - Aux2.

**Digital A, Setpoint**

If more than one heater is installed, select the spa heater you wish to control. If no heaters are installed, "Heaters Disabled" will be displayed.

Remote Menus  
Enabled

- + - Toggle between Enabled (default) and Disabled Remote Menus
- <> Move to previous/next configuration menu

This feature will prevent unauthorized access to the Settings, Timers, and Configuration menus from any of the Pro Logic's remote display/keypads. When disabled, the remote display/keypads will only show the default menu and allow on/off control via the pushbuttons. Note that the function of the Pro Logic's built-in display/keypad is unchanged by this selection. Once disabled, the only way to enable "Remote Menus" is to use the local display/keypad.

All Timeclocks  
7-day

- + - Toggle between 7-day (default) and Weekend/Weekday time options
- <> Move to previous/next configuration menu

This selection affects ALL of the timeclock logic in the Pro Logic. If "7-day" is selected, each timeclock will have one set of turn-on/turn-off settings that operate every day of the week. If "Weekend/Weekdays" option is selected then the user can enter one set of turn-on/turn-off times for the weekend (fixed as Saturday/Sunday) and another set of turn-on/turn-off times for weekdays (Monday through Friday).

Time Format  
12 hour AM/PM

- + - Toggle between 12 hour AM/PM (default) and 24 hour time format options
- <> Move to previous/next configuration menu

Units  
°F and PPM

- + - Toggle between °F and PPM (default) and °C and g/L (Metric) options
- <> Move to previous/next configuration menu

*if any output is configured as a variable speed pump*

VSP Speed  
%

- + - Toggle between % and RPM
- <> Move to previous/next configuration menu

This is the unit of measure for displaying the speed of the variable speed pump. Select % of your pump's maximum speed or revolutions per minute (RPM).

*if ColorLogic Network Module is detected*

Reset ColorLogic to Default Press +	+ Initiate reset of ColorLogic configuration parameters <> Move to previous/next configuration menu (config. not reset)
Are you sure? + to proceed	+ Reset all configuration parameters <> Move to previous/next menu (config. not reset)
ColorLogic. reset Confirmed	<> Move to previous/next configuration menu

Use this function to erase all ColorLogic configuration settings and reset back to the factory default values. This function is NOT reversible--be careful.

Reset Config. to Default Press +	+ Initiate reset of all configuration parameters <> Move to previous/next configuration menu (config. not reset)
Are you sure? + to proceed	+ Reset all configuration parameters <> Move to previous/next menu (config. not reset)
Config. reset Confirmed	<> Move to previous/next configuration menu

Use this function to erase all previous system configuration settings and reset all configuration parameters back to the factory default values. This function is NOT reversible--be careful.

## Maintenance Menu (only displays if Sensing System is enabled)

The Maintenance Menu will be displayed only if the optional AQL-CHEM is used and the Sensing System is enabled in the Chemistry Config. Wizard. This menu is used to perform functions relating to the AQL-CHEM ORP and pH sensing kit.

pH Calibration Wizard, + to enter	+ Push to access pH Calibration Wizard <> Move to previous/next menu item
-----------------------------------	--

Use this Wizard to calibrate the AQL-CHEM's pH probe. This requires a manual pH test of the pool water using a dependable red phenol test kit.

Clean Probe Wizard + to enter	+ Push to access Clean Probe Wizard <> Move to previous/next menu item
-------------------------------	---

Use this Wizard to clean the AQL-CHEM's ORP and pH probes. The probes must be clean and free from oil, chemical deposits and contamination to function properly. Slow response, increased need to calibrate, and inconsistent readings are indications that the probes need to be cleaned.

# Quick “How To” Guide

## Operate the Spa—Manually

1. Press the “Pool/Spa” button to go to “spa-only” operation (“SPA” LED illuminated). In some cases, this may take more than one press of the button.
2. If the filter pump is not already on, press the “FILTER” button to turn it on.
3. If the spa is below the desired temperature, the heater will turn on automatically when the filter pump is on and the valves are in the spa-only position. If you have not already set the desired temperature for the spa, see “Set Heater Temperature” below
4. If the spa has a separate jet pump and or blower, determine if the jet pump/blower is controlled by any Aux or the Lights relay (it should be marked on the label inside the door). Then press the appropriate button to turn on the jets/blower.

## Operate the Spa—Automatically

1. Press the “MENU” button repeatedly until “Timers Menu” is displayed
2. Press the “>” button repeatedly until the “Spa—all days” or “Spa—weekends” is displayed.
3. Use the “+” and “-“ buttons to set the desired start time, then press “>” to switch to the off time. Use the “+” and “-“ buttons to adjust the off time. If you are setting the “weekend” timeclock, press “>” to go to the “weekday” settings.

*Note: During the programmed spa time, the valves will automatically switch to the “spa-only” position, the filter pump will turn on, and, if the spa is not up to the desired temperature, the heater will start. This operation is the highest priority and will take precedence over other automatically programmed operations. At the end of the spa period, the Pro Logic will return to its normally programmed operation state.*

## Set the Heater Temperature (or turn heater permanently off)

1. Press the “MENU” button repeatedly until “Settings Menu” is displayed
2. Press the “>” button repeatedly until the “Spa Heater” or “Pool Heater” is displayed.
3. Press the “+” or “-“ buttons repeatedly to adjust the temperature. If you adjust the temperature below 65°F or above 104°F the display will indicate “off” and the heater will not operate regardless of temperature.

*Note: Separate temperatures for the pool and spa must be set. If the valves are in the pool-only or spa spillover positions, then the heater will use the pool setting. If the valves are in the spa-only position then the heater will operate according to the spa setting.*

## Set the Chlorinator Output

1. Press the “MENU” button repeatedly until “Settings Menu” is displayed.
2. Press the “>” button repeatedly until the “Spa Chlorinator” or “Pool Chlorinator” is displayed.
3. Press the “+” or “-“ buttons repeatedly to adjust the setting. If you adjust the setting to 0% the chlorinator will be off all the time.

*NOTE: After the ideal "Desired Output %" setting has been found, you may need to raise the setting when the pool water temperature increases significantly, when there is higher than normal bather load or when your chlorinator cell ages. You may need to lower the setting when the pool water temperature decreases significantly or there are long periods of inactivity.*

*Note: Separate chlorinator output levels for the pool and spa must be set. If the valves are in the pool-only or spa spillover positions, then the chlorinator will operate per the pool setting. If the valves are in the spa-only position then the chlorinator will operate according to the spa setting. The actual amount of chlorine introduced into the pool/spa is determined by: this output setting, the amount of time the filter pump is running, the water temperature, and the amount of salt in the water. Also see Start/Stop Superchlorination below.*

## **Start/Stop Superchlorination**

1. Press the “MENU” button repeatedly until “Settings Menu” is displayed
2. Press the “>” button repeatedly until “Super Chlorinate” is displayed.
3. The display will show whether superchlorination is “on” or “off”.
4. Press “+” or “-” to toggle between “on” and “off”

*Note: Once started, superchlorination will run for the programmed number of hours (Timers Menu/Super Chlorinate Hours) or until you manually turn it off. Superchlorination may be temporarily interrupted for a programmed spa operation.*

## **Program a Timeclock**

1. Press the “MENU” button repeatedly until “Timers Menu” is displayed
2. Press the “>” button repeatedly until the “xxx—all days” or “xxx—weekends” is displayed.
3. Use the “+” and “-“ buttons to set the desired start time, then press “>” to switch to the off time. Use the “+” and “-“ buttons to adjust the off time. If you are setting the “weekend” timeclock, press “>” to go to the “weekday” settings.

*Note: During the programmed time, there may be other automatic or manual operations that prevent the relay/valve from operating—see a more detailed discussion under Automatic System Operation/Timers Menu/Aux Timeclock or in Troubleshooting/Diagnostic Information.*

## **Program a Countdown Timer**

1. Press the “MENU” button repeatedly until “Timers Menu” is displayed
2. Press the “>” button repeatedly until the “xxx—CountDn” is displayed.
3. Use the “+” and “-“ buttons to set the desired timer period.

*Note: A setting of 0:00 will display as “Manual On/Off.” The countdown automatic turn off function is disabled by manual operation is still permitted. There may be other automatic or manual operations that prevent the relay/valve from operating—see a more detailed discussion under Automatic System Operation/Timers Menu/Aux Timeclock or in Troubleshooting/Diagnostic Information.*

## **Enter/Exit Service (or Service—Timed) Mode**

1. Go to Pro Logic main unit (normally mounted near the pool equipment)
2. Pressing the “Service” button rotates through normal operation (red LED off), service mode (red LED on continuously) and service-timed mode (red LED flashing).

*Note: This operation can only be performed at the main Pro Logic unit. Both “Service” and “Service-Timed” disable all automatic programmed operations and allow manual operation from the main unit only. The buttons on the remote display/keypads will still be able to turn equipment off in case of an emergency, but will not turn any equipment on. If the system is in “Serviced-Timed” it will automatically switch back to normal operation at the end of the time period.*

# Chlorinator Operation / Water Chemistry

## General Water Chemistry

Salt is required only if you are using the chlorinator features on the Pro Logic Control. If you are NOT using the chlorinator, it is recommended that you follow all of the other chemistry recommendations besides salt. Refer to the description of the Pro Logic configuration menu for information on enabling/disabling the chlorinator (see page 17).

## Water Chemistry

The table below summarizes the levels that are recommended by the Association of Pool and Spa Professionals (APSP). The only special requirements for the Pro Logic are the salt level and stabilizer.

CHEMICAL	IDEAL LEVELS
Salt	2700 to 3400 ppm
Free Chlorine	1.0 to 3.0 ppm
pH	7.2 to 7.8
Cyanuric Acid (Stabilizer)	60 to 80 ppm (80 ppm best)
Total Alkalinity	80 to 120 ppm
Calcium Hardness	200 to 400 ppm
Metals	0 ppm
Saturation Index	-.2 to .2 (0 best)

## Saturation index

The saturation index (Si) relates to the calcium and alkalinity in the water and is an indicator of the pool water “balance”. Your water is properly balanced if the Si is  $0 \pm 0.2$ . If the Si is below  $-0.2$ , the water is corrosive and plaster pool walls will be dissolved into the water. If the Si is above  $+0.2$ , scaling and staining will occur. Use the chart below to determine the saturation index.

$$Si = pH + Ti + Ci + Ai - 12.1$$

°C	°F	Ti	Calcium Hardness	Ci	Total Alkalinity	Ai
12	53	.3	75	1.5	75	1.9
16	60	.4	100	1.6	100	2.0
19	66	.5	125	1.7	125	2.1
24	76	.6	150	1.8	150	2.2
29	84	.7	200	1.9	200	2.3
34	94	.8	250	2.0	250	2.4
39	103	.9	300	2.1	300	2.5
			400	2.2	400	2.6
			600	2.4	600	2.8
			800	2.5	800	2.9

*How to use:* Measure pool pH, temperature, calcium hardness, and total alkalinity. Use the chart above to determine Ti, Ci, and Ai from your measurements. Insert values of pH, Ti, Ci and Ai into the above equation. If Si equals .2 or more, scaling and staining may occur. If Si equals -.2 or less corrosion or irritation may occur.

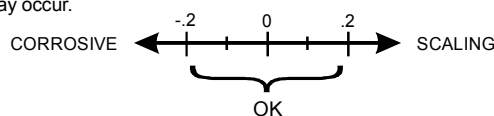

The pool's chemistry must be balanced BEFORE activating the Pro Logic's optional chlorinator function. NOTE: If the pool does not have new water, add metal remover and non-copper based algaecide to the pool, per manufacturer's instructions. This ensures a quick, troublefree transfer to the Pro Logic system.

### Salt Level (When using optional chlorinator function)

Use the chart on the following page to determine how much salt in pounds or (Kgs) should be added to reach the recommended levels. Use the equations below (measurements are in feet/gallons and meters/liters) if pool size is unknown.

	<b>Gallons</b> (pool size in feet)	<b>Liters</b> (pool size in meters)
<b>Rectangular</b>	Length x Width x Average Depth x 7.5	Length x Width x Average Depth x 1000
<b>Round</b>	Diameter x Diameter x Average Depth x 5.9	Diameter x Diameter x Average Depth x 785
<b>Oval</b>	Length x Width x Average Depth x 6.7	Length x Width x Average Depth x 893

The operating salt level is between 2700-3400 PPM (parts per million) with 3200 PPM being optimal. Before adding any salt, test the salt level. This is especially important for retrofit installation to older pools where chlorine added to the pool over time has ended up as salt. If the level is low, determine the number of gallons in the pool and add salt according to the chart below. A low salt level will reduce the efficiency of the sanitization and result in low chlorine production. A high salt level can cause the Pro Logic to stop chlorinating. The salt in your pool/spa is constantly recycled and the loss of salt throughout the swimming season should be minimal. This loss is due primarily to the addition of water because of splashing, backwashing, or draining (because of rain). Salt is not lost due to evaporation.

### Type of Salt to Use

It is important to use only sodium chloride (NaCl) salt that is greater than 99.0% pure. This can be found at most pool stores in 40-80 lb. bags labeled "for use in swimming pools". Alternatively, use common food quality or water softener salt that is at least 99.0% pure. It is also acceptable to use water conditioning salt pellets, however, it will take longer for them to dissolve. Do not use rock salt, or salt with more than 1% of yellow prussiate of soda, salt with anti-caking additives, or iodized salt.

### How to Add Salt

For new plaster pools, wait 10-14 days before adding salt to allow the plaster to cure. Turn the circulating pump on and add salt directly into the pool. Brush the salt around to speed up the dissolving process—do not allow salt to pile up on the bottom of the pool. Run the filter pump for 24 hours with the suction coming from the main drain (use pool vacuum if there is no main drain) to allow the salt to evenly disperse throughout the pool. The salt display may take 24 hours to respond to the change in salt concentration.

Always check stabilizer (cyanuric acid), when checking salt. These levels will most likely decline together. Use the chart on page 38 to determine how much stabilizer must be added to raise the level to 80 ppm.

**POUNDS and (Kg) OF SALT NEEDED FOR 3200 PPM**

Current salt level ppm	Gallons and (Liters) of Pool/Spa water																
	8,000 (30,000)	10,000 (37,500)	12,000 (45000)	14,000 (52,500)	16,000 (60,000)	18,000 (67,500)	20,000 (75,000)	22,000 (82,500)	24,000 (90,000)	26,000 (97,500)	28,000 (105,000)	30,000 (112,500)	32,000 (120,000)	34,000 (127,500)	36,000 (135,000)	38,000 (142,500)	40,000 (150,000)
<b>0</b>	213 (97)	267 (121)	320 (145)	373 (170)	427 (194)	480 (218)	533 (242)	587 (267)	640 (291)	693 (315)	747 (339)	800 (364)	854 (388)	907 (412)	960 (436)	1013 (460)	1067 (484)
<b>200</b>	200 (91)	250 (114)	300 (136)	350 (159)	400 (182)	450 (205)	500 (227)	550 (250)	600 (273)	650 (295)	700 (318)	750 (341)	800 (363)	850 (385)	900 (408)	950 (430)	1000 (453)
<b>400</b>	187 (85)	233 (106)	280 (127)	327 (148)	373 (170)	420 (191)	467 (212)	513 (233)	560 (255)	607 (276)	653 (297)	700 (318)	747 (339)	793 (360)	840 (382)	887 (403)	933 (424)
<b>600</b>	173 (79)	217 (98)	260 (118)	303 (138)	347 (158)	390 (177)	433 (197)	477 (217)	520 (236)	563 (256)	607 (276)	650 (297)	693 (317)	737 (337)	780 (358)	823 (378)	867 (398)
<b>800</b>	160 (73)	200 (91)	240 (109)	280 (127)	320 (145)	360 (164)	400 (182)	440 (200)	480 (218)	520 (236)	560 (255)	600 (273)	640 (291)	680 (310)	720 (328)	760 (346)	800 (364)
<b>1000</b>	147 (67)	183 (83)	220 (100)	257 (117)	293 (133)	330 (150)	367 (167)	403 (183)	440 (200)	477 (217)	513 (233)	550 (250)	587 (267)	623 (283)	660 (300)	697 (317)	733 (333)
<b>1200</b>	133 (61)	167 (76)	200 (91)	233 (106)	267 (121)	300 (136)	333 (152)	367 (167)	400 (182)	433 (197)	467 (212)	500 (227)	533 (243)	567 (258)	600 (274)	633 (289)	667 (304)
<b>1400</b>	120 (55)	150 (68)	180 (82)	210 (95)	240 (109)	270 (123)	300 (136)	330 (150)	360 (164)	390 (177)	420 (191)	450 (205)	480 (218)	510 (232)	540 (246)	570 (259)	600 (263)
<b>1600</b>	107 (48)	133 (61)	160 (73)	187 (85)	213 (97)	240 (109)	267 (121)	293 (133)	320 (145)	347 (158)	373 (170)	400 (182)	427 (195)	453 (207)	480 (219)	507 (231)	533 (243)
<b>1800</b>	93 (42)	117 (53)	140 (64)	163 (74)	187 (85)	210 (95)	233 (106)	257 (117)	280 (127)	303 (138)	327 (148)	350 (159)	373 (169)	397 (180)	420 (190)	443 (201)	467 (211)
<b>2000</b>	80 (36)	100 (45)	120 (55)	140 (64)	160 (73)	180 (82)	200 (91)	220 (100)	240 (109)	260 (118)	280 (127)	300 (136)	320 (145)	340 (154)	360 (163)	380 (172)	400 (181)
<b>2200</b>	67 (30)	83 (38)	100 (45)	117 (53)	133 (61)	150 (68)	167 (76)	183 (83)	200 (91)	217 (98)	233 (106)	250 (114)	267 (121)	283 (129)	300 (137)	317 (144)	333 (152)
<b>2400</b>	53 (24)	67 (30)	80 (36)	93 (42)	107 (48)	120 (55)	133 (61)	147 (67)	160 (73)	173 (79)	187 (85)	200 (91)	213 (98)	227 (104)	240 (110)	253 (117)	267 (123)
<b>2600</b>	40 (18)	50 (23)	60 (27)	70 (32)	80 (36)	90 (41)	100 (45)	110 (50)	120 (55)	130 (59)	140 (64)	150 (68)	160 (73)	170 (77)	180 (81)	190 (86)	200 (90)
<b>2800</b>	27 (12)	33 (15)	40 (18)	47 (21)	53 (24)	60 (27)	67 (30)	73 (33)	80 (36)	87 (39)	93 (42)	100 (45)	107 (48)	113 (51)	120 (54)	127 (57)	133 (60)
<b>3000</b>	13 (6)	17 (8)	20 (9)	23 (11)	27 (12)	30 (14)	33 (15)	37 (17)	40 (18)	43 (20)	47 (21)	50 (23)	53 (24)	57 (26)	60 (27)	63 (29)	67 (30)
<b>3200</b>	Ideal	Ideal	Ideal	Ideal	Ideal	Ideal	Ideal	Ideal	Ideal	Ideal	Ideal	Ideal	Ideal	Ideal	Ideal	Ideal	Ideal
<b>3400</b>	OK	OK	OK	OK	OK	OK	OK	OK	OK	OK	OK	OK	OK	OK	OK	OK	OK
<b>3600+</b>	Dilute	Dilute	Dilute	Dilute	Dilute	Dilute	Dilute	Dilute	Dilute	Dilute	Dilute	Dilute	Dilute	Dilute	Dilute	Dilute	Dilute



**POUNDS and (Kg) OF STABILIZER (CYANURIC ACID) NEEDED FOR 80 PPM**

Current Stabilizer Level (ppm)	Gallons and (Liters) of Pool/Spa water																
	8,000 (30000)	10,000 (37500)	12,000 (45000)	14,000 (52500)	16,000 (60000)	18,000 (67500)	20,000 (75000)	22,000 (82500)	24,000 (90000)	26,000 (97500)	28,000 (105000)	30,000 (112500)	32,000 (120000)	34,000 (127500)	36,000 (135000)	38,000 (142500)	40,000 (150000)
<b>0 ppm</b>	5.3 (3.6)	6.7 (4.3)	8.0 (3.6)	9.4 (4.3)	10.7 (4.9)	12.0 (5.4)	13.4 (6.1)	14.7 (6.7)	16.0 (7.3)	17.3 (7.9)	18.7 (8.5)	20.0 (9.1)	21.3 (9.7)	22.7 (10.3)	24.0 (10.9)	25.3 (11.5)	26.7 (12.0)
<b>10 ppm</b>	4.7 (3.2)	5.8 (3.7)	7.0 (3.2)	8.2 (3.7)	9.4 (4.3)	10.5 (4.8)	11.7 (5.3)	12.9 (5.9)	14.0 (6.4)	15.2 (6.9)	16.4 (7.4)	17.2 (8.0)	18.7 (8.5)	19.8 (9.0)	21.0 (9.5)	22.2 (10.0)	23.3 (10.5)
<b>20 ppm</b>	4.0 (2.7)	5.0 (3.2)	6.0 (2.7)	7.0 (3.2)	8.0 (3.6)	9.0 (2.2)	10.0 (4.5)	11.0 (5.0)	12.0 (5.4)	13.0 (5.9)	14.0 (6.4)	15.0 (6.8)	16.0 (7.2)	17.0 (7.7)	18.0 (8.1)	19.0 (8.6)	20.0 (9.0)
<b>30 ppm</b>	3.3 (2.3)	4.2 (2.7)	5.0 (2.3)	5.9 (2.7)	6.7 (3.0)	7.5 (3.4)	8.4 (3.8)	9.2 (4.2)	10.0 (4.5)	10.8 (4.9)	11.7 (5.2)	12.5 (5.6)	13.3 (6.0)	14.2 (6.3)	15.0 (6.7)	15.8 (7.1)	16.7 (7.5)
<b>40 ppm</b>	2.7 (1.8)	3.3 (2.1)	4.0 (1.8)	4.7 (2.1)	5.4 (2.4)	6.0 (2.7)	6.7 (3.0)	7.4 (3.3)	8.0 (3.6)	8.7 (3.9)	9.3 (4.2)	10.0 (4.5)	10.7 (4.8)	11.3 (5.1)	12.0 (5.4)	12.7 (5.7)	13.3 (6.0)
<b>50 ppm</b>	2.0 (1.4)	2.5 (1.6)	3.0 (1.4)	3.5 (1.6)	4.0 (1.8)	4.5 (2.0)	5.0 (2.3)	5.5 (2.5)	6.0 (2.7)	6.5 (2.9)	7.0 (3.2)	7.5 (3.4)	8.0 (3.6)	8.5 (3.9)	9.0 (4.1)	9.5 (4.3)	10.0 (4.5)
<b>60 ppm</b>	1.3 (0.91)	1.7 (1.1)	2.0 (0.91)	2.3 (1.1)	2.7 (1.2)	3.0 (1.4)	3.3 (1.5)	3.7 (1.7)	4.0 (1.8)	4.3 (2.0)	4.7 (2.1)	5.0 (2.3)	5.3 (2.4)	5.7 (2.6)	6.0 (2.7)	6.3 (2.8)	6.7 (3.0)
<b>70 ppm</b>	0.7 (0.45)	0.8 (0.54)	1.0 (0.45)	1.2 (0.54)	1.4 (0.64)	1.5 (0.68)	1.7 (0.77)	1.8 (0.82)	2.0 (0.91)	2.2 (1.0)	2.3 (1.1)	2.5 (1.2)	2.7 (1.2)	2.8 (1.3)	3.0 (1.3)	3.2 (1.4)	3.3 (1.5)
<b>80 ppm</b>	0.0	0.0	0.0	0.0	0.0	0.0	0.0	0.0	0.0	0.0	0.0	0.0	0.0	0.0	0.0	0.0	0.0

# System Maintenance

To maintain maximum performance, it is recommended that you open and visually inspect the cell every 3 months or after cleaning your filter. The Pro Logic will remind you to do this by displaying the message “Inspect/Clean Cell” after approximately 500 hours of operation.

The Pro Logic electrolytic cell has a self cleaning feature incorporated into the electronic control’s logic. In most cases this self cleaning action will keep the cell working at optimum efficiency. In areas where water is hard (high mineral content) or in pools where the water chemistry has been allowed to get “out of balance”, the cell may require periodic cleaning.

## Servicing and Cleaning the Turbo Cell

Turn off power to the Pro Logic before removing the electrolytic cell. Once removed, look inside the cell and inspect for scale formation (light colored crusty or flaky deposits) on the plates and for any debris which has passed through the filter and caught on the plates. If no deposits are visible, reinstall. If deposits are seen, use a high pressure garden hose and try to flush the scale off. If this is not successful, use a plastic or wood tool (do not use metal as this will scratch the coating off the plates) and scrape deposits off of plates. Note that a buildup on the cell indicates that there is an unusually high calcium level in the pool (old pool water is usually the cause). If this is not corrected, you may have to periodically clean the cell. The simplest way to avoid this is to bring the pool chemistry to the recommended levels as specified.

**Mild Acid Washing:** Use only in severe cases where flushing and scraping will not remove the majority of deposits. To acid wash, turn off power to Pro Logic. Remove cell from piping. In a clean plastic container, mix a 2:1 solution of water to muriatic acid (one gallon of water to two quarts of muriatic acid). ALWAYS ADD ACID TO WATER - NEVER ADD WATER TO ACID. Be sure to wear rubber gloves and appropriate eye protection. The level of the solution in the container should just reach the top of the cell so that the wire harness compartment is NOT submerged. It may be helpful to coil the wiring before immersing the cell. The cell should soak for a few minutes and then rinse with a high pressure garden hose. If any deposits are still visible, repeat soaking and rinsing. Replace cell and inspect again periodically.

## Winterizing

The Pro Logic electrolytic cell and flow detection switch will be damaged by freezing water just as your pool plumbing would. In areas of the country which experience severe or extended periods of freezing temperatures, be sure to drain all water from the pump, filter, and supply and return lines before any freezing conditions occur. The electronic control is capable of withstanding any winter weather and should not be removed.

If you are in an area that only experiences occasional freezing conditions, your Pro Logic system may be set up to circulate the pool water whenever the air sensor drops to the selected freeze temperature threshold. Make sure the air sensor is recording the correct temperature and is NOT located in the direct sunlight to ensure proper freeze protection operation.

## Spring Start-up

When first starting the pool in the spring time, it is highly recommended that you temporarily set the pool and spa chlorinator settings (Settings Menu/Pool Sanitizer & Spa Sanitizer) to 0% (off) and then manually shock the pool with any chlorine based shock product and balance the pool water chemistry per the levels indicated in the Chlorinator Operation section. Make sure to check the salt and stabilizer levels and bring them up to the recommended levels. Your local Authorized Hayward Dealer or pool store can recommend the best chemical treatment for your pool. After the water is clear and balanced, then go back and adjust the pool and spa chlorinator settings to the appropriate levels. Test the pool chlorine level weekly and adjust the chlorinator settings up or down accordingly.

It is usually a good idea to also inspect the cell and clean if necessary at the start of the season. See instructions above.

# Troubleshooting and Diagnostic Information

The Pro Logic provides 2 different tools to aid in troubleshooting any problems that may occur in your pool and/or spa system. The Service mode will allow you to disable automatic operation and manually control most of the equipment (the heater and general purpose Valve3 output are the exceptions). The Diagnostic Menu will provide some detailed information regarding system operation.

While both of the features are primarily intended for the use of the professional service technician, their function is fully explained below. If you believe your system is not operating properly or have questions regarding the operation, call the Hayward Technical Service Dept. from Monday through Friday, 8AM to 8PM EST at 908-355-7995.

## Service Mode

The main unit keypad has a SERVICE button that is used primarily during servicing of the pool equipment.

If you want to completely disable the automatic operation and operate the system manually, you can put the system into Service or Service-Timed mode by pressing the “Service” button. Pressing the “SERVICE” button once will switch the system into service mode which means that all automatic functions are disabled, the optional remote display/keypads are disabled (except for manual turn off for emergencies). The outputs can be manually controlled by pressing the buttons on the local display/keypad. The red “SERVICE” LED will be illuminated and the Pro Logic will remain in this mode of operation until manually taken out of service mode.

Pressing the “SERVICE” button again will cause the Pro Logic to switch to service-timed mode which is very similar to service mode, except that the Pro Logic will automatically return to normal operation after 3 hours. During service timed operation, the “SERVICE” LED will flash and the time remaining will be displayed on the remote display(s).

Pressing the “SERVICE” button again, will return the Pro Logic to normal (automatic) operation.

## Check System Indicator

The “CHECK SYSTEM” LED will alert you when the Pro Logic detects any of the following conditions that are abnormal and require attention for optimal operation of your pool. Press “<” or “>” to view all of the existing “Check System” conditions.

- **Inspect Cell** -- For optimum operation, you will need to inspect the Pro Logic chlorinator cell approximately every 3 months and clean the cell if necessary. The Pro Logic will automatically remind you when it is time and display “Inspect Cell, + to reset” as part of the rotating Default Menu. Clean the cell and then press the “+” button during the “Inspect Cell” display to reset the timer.
- **Low Salt/Minerals or Very Low Salt/Minerals** -- When the salt is too low the Pro Logic will generate less chlorine and the life of the cell is degraded. Check the cell and clean if necessary before adding salt.
- **High Salt/Amps/Minerals** -- The Pro Logic will stop generating chlorine under certain high salt conditions in order to protect the internal electronics from damage. The only way to lower the salt level is to partially drain the pool and add fresh water.
- **Water/Pool Sensor** -- If the water or pool (if Dual Equipment) sensor is either an open or short circuit.
- **Air sensor** -- If the freeze protection feature is enabled (Configuration Menu/ Filter Config.) and the air sensor is either an open or short circuit.
- **Solar sensor** -- If Solar is enabled and the solar sensor is either an open or short circuit.
- **Spa sensor for Dual Equipment**-- If dual equipment spa sensor is either an open or short circuit.
- **Chlorinator Cell sensor** -- If the chlorinator function enabled (Configuration Menu/Chlorinator) and the cell sensor is either an open or short circuit.

- **PS-16 Communication Error** -- If an PL-PS-16 and the Expansion Unit is not responding.
- **Low Volts** -- If the chlorinator cell voltage is too low.
- **No Cell Power** -- If no chlorinator cell power is detected on the printed circuit board.
- **Chk Flow Switch** -- If the flow switch input is invalid.
- **Cell Power Error** -- If a chlorinator cell power error is detected on the printed circuit board.
- **No Flow-Filter Pump** -- If the filter pump is on and the flow switch indicates no flow for 15 minutes or more.
- **Cell Missing** -- If the chlorinator is enabled but no cell is detected.
- **Pool Filter VSP Comm Error**-- If variable speed is selected for the Pool Filter and the Hayward VSP interface is not responding.
- **Pool Filter VSP Drive Comm Error** -- If variable speed is selected for the Pool Filter and the Hayward VSP drive controller is not responding.
- **Pool Filter VSP Err: x** -- If variable speed is selected for the Pool Filter and the Hayward VSP is indicating and error. x is the same decimal error displayed by the VSP itself.
- **Spa Filter VSP Comm Error** -- If variable speed is selected for the Dual Equipment Spa Filter and the Hayward VSP interface is not responding.
- **Spa Filter VSP Drive Comm Error** -- If variable speed is selected for the Dual Equipment Spa Filter and the Hayward VSP drive controller is not responding.
- **Spa Filter VSP Err: x** -- If variable speed is selected for the Dual Equipment Spa Filter and the Hayward VSP is indicating and error. x is the same decimal error displayed by the VSP itself.
- **Aux1 VSP Comm Error** -- If variable speed is selected for the Aux1 relay type and the Hayward VSP interface is not responding.
- **Aux1 VSP Drive Comm Error** -- If variable speed is selected for the Aux1 relay type and the Hayward VSP drive controller is not responding.
- **Aux1 VSP Err: x** -- If variable speed is selected for the Aux1 relay type and the Hayward VSP is indicating and error. x is the same decimal error displayed by the VSP itself.

For Pool Filter, Spa Filter and Aux using Gen2 EcoStar Variable Speed Pumps only:

- **Main Voltage is too low**
- **Main Voltage is too high**
- **Remote Stop was pressed (Press “+” to restart)**
- **Prime Failed (Press “+” to restart)**
- **Failed to start (Press “+” to restart)**
- **Pump has stalled (Press “+” to restart)**
- **SVRS tripped (Press “+” to restart)**
- **Drive failure (see Pump Display)**
- **CSM Comm Error:** -- If Chemistry Sensing is enabled and the Chemistry Sense Module (CSM) is not responding.
- **pH Probe Error** -- If the CSM indicates that there is a problem with the pH probe.
- **pH Low - Check Feeder** -- If a pH level of 6.9 or less is detected, check the feeder for proper operation
- **pH High - Check Feeder** -- If a pH level of 8.1 or higher is detected, check the chemical supply and the feeder for proper operation

- **pH Timeout - Check Feeder** -- If the unit has been dispensing pH for more than the selected timeout without reaching the desired level. Check the chemical supply and the feeder. If both are OK, the timeout may need to be increased. Press the “+” button to reset the alarm and resume dispensing.
- **pH Calibration Error** -- When using the pH Calibration Wizard and the entered test result was different from the measured pH level by  $\pm 1.0$  or more. The pH probe may need to be cleaned or replaced.
- **ORP Probe Error** -- If the CSM indicates that there is a problem with the ORP probe.
- **ORP Low - Check Chlor** -- If an ORP level of 350mV or less is detected. Check the chlorinator for proper operation.
- **ORP High - Check Chlor** -- If an ORP level of 950mV or higher is detected. Check the chlorinator for proper operation.
- **ORP High - Chlor Off** -- If an ORP level of 950mV or higher is detected and the chlorine feed mode is ORP Auto Sensing, the chlorinator has been turned off. Check the chlorinator for proper operation.
- **ORP Timeout -Chlor Off** -- If the unit has been chlorinating for more than the selected sanitizer timeout without reaching the desired level, the chlorinator has been turned off. Press the “+” button to reset the alarm and resume chlorination.
- **Ambient Sensor**-- If the Pro Logic internal temperature sensor is either an open or short circuit.

For helpful troubleshooting information on any of these issues, go to the Diagnostic Menu and then scroll through the various items until you see the cause for the “CHECK SYSTEM” LED being illuminated.

## Diagnostic Menu

To enter the Diagnostic Menu, press the “Menu” button repeatedly until the display shows “Diagnostic Menu”. At this point, you can use either the “<” or “>” buttons to scroll through the various menu items which are described below:

+23.45	+6.75A	<b>+ -</b> Press to switch chlorinator operation to opposite polarity (15 second delay) <b>&lt; &gt;</b> Move to previous/next menu item
84°F	3200PPM	

+/- 23.45V is the voltage applied to the chlorinator cell  
 +/-6.75A is the current (amps) through the cell  
 84°F is the water temperature at the cell  
 3200PPM is the “instant” salt level at this time

*This display will be shown only if the chlorinator is enabled.* For the chlorinator to be operating, several other things must be happening: the filter pump must be running, the flow switch must be detecting flow, the chlorinator setting must be set greater than 0%, the water temperature at the cell must be between 50°F and 140°F, and the salt level must be within the operating range. If any of these conditions are not met, the chlorinator diagnostic display will tell you the reason. It’s possible to have more than one reason, in which case after you rectify what was displayed the first time, a second display will appear.

If the current (amps) display is 0.00A, then the chlorinator is operating normally but is in the off part of its normal operating cycle. Simply press either the “+” or “-“ key to start a new cycle.

The Pro Logic periodically reverses the polarity of the voltage applied to the cell in order to automatically clean off any calcium deposits. It is important that you check the chlorinator operation in both polarities. To do this, press either the “+” or “-“ buttons and the chlorinator will turn off, wait for 15 seconds and then turn on in the opposite polarity.

If a conventional or solar heater is operating, it is likely that the temperature of the water at the cell is higher than the pool/spa water temperature displayed on the Pro Logic default display.

Instant Salt  
3200 PPM (+=save)

- + Press to load the “Instant Salt” into the averaged salt display
- <> Move to previous/next menu item

*This display will be shown only if the chlorinator is enabled.* This display shows “Instant Salt” or “Instant Minerals” (if Chlor. Config. is set for “Display Minerals”). The “Instant Salt” is calculated based on the voltage, current (amps), and water temperature at the cell. This is different than the “average salt” value which is displayed as part of the default menu. There are a number of reasons why instant and average salt readings may differ. Some of these include salt having just been added to the pool and not yet thoroughly mixed, calcium buildup on the cell, and the cell aging.

*if AQL-CHEM is used*

pH 7.5 (On)  
ORP 700 mV (On)

- + - No function
- <> Move to previous/next menu item

*This display will be shown only if sensing is enabled.* This display shows both pH and ORP levels/status when chemistry sensing is enabled via the Chemistry Configuration Wizard (requires the use of AQL-CHEM Sensing Kit). The Pro Logic will refer to these levels to determine how much chlorine to generate (ORP) and, if using an AQL-CHEM2 dispense kit, how much CO<sub>2</sub> or acid to dispense (pH). Refer to the AQL-CHEM manual for specific information about these levels as well as the recommended ranges.

Flow Switch  
Flow

- + - No function
- <> Move to previous/next menu item

*This display will be shown only if the chlorinator is enabled.* The current status of the flow switch is displayed. There is a short delay when transitioning from flow to no-flow and a longer delay on the transition from no-flow to flow. The delay time is displayed.

Cell Temp Sensor  
77°F

- + - No function
- <> Move to previous/next menu item

Water Sensor  
Open circuit

- + - No function
- <> Move to previous/next menu item

Spa Sensor  
Open circuit

- + - No function
- <> Move to previous/next menu item

Air Sensor  
94°F

- + - No function
- <> Move to previous/next menu item

Solar Sensor  
Short circuit

- + - No function
- <> Move to previous/next menu item

NOTE: If Pool and Spa-Dual is selected, the water sensor will display as “Pool Sensor”.

Displays actual speed (in % or RPM) and power consumption (in Watts) as reported by the selected VSP.

If the sensor appears to be operating properly, then the temperature will be displayed. If this temperature is not correct then check the placement of the sensor. If the problem is not placement related, then the sensor will, most likely, require replacement. If the display is “Open Circuit” or “Short Circuit” then check the wiring to the sensor and also make sure that the wires are secure in the terminal block in the Pro Logic main unit.

*if Gen 2 VSPs are detected*

VSP Speed/Power ± to view	+ - Push to view the actual speed and power reported by the VSP <> Move to previous/next menu item
Filter Sp:1035RPM Pwr:111w	+ - No function <> Move to previous/next menu item

Main Software Revision 4.00	+ - No function <> Move to previous/next menu item
--------------------------------	---

Display Software remote-08 r3.10	+ - No function <> Move to previous/next menu item
-------------------------------------	---

Exp. Unit Software Revision 1.10	+ - No function <> Move to previous/next menu item
-------------------------------------	---

Chemistry Sense Software r1.00	+ - No function <> Move to previous/next menu item
-----------------------------------	---

VSP Software ± to view	+ - Push to view the software revision of the connected VSPs <> Move to previous/next menu item
---------------------------	--

*if TriStar VSPs are detected*

Pool Filter Bridge Software r1.00	+ - No function <> Move to previous/next menu item
--------------------------------------	---

*if EcoStar VSPs are detected*

Pool Filter Display Software r1.00	+ - No function <> Move to previous/next menu item
---------------------------------------	---

*if TriStar VSPs are detected*

Pool Filter VSC Software r1.00	+ - No function <> Move to previous/next menu item
-----------------------------------	---

*if EcoStar VSPs are detected*

Pool Filter Drive Software r1.00	+ - No function <> Move to previous/next menu item
-------------------------------------	---

RF Base Software r1.20 ID:1234	+ - No function <> Move to previous/next menu item
-----------------------------------	---

6B Spa Software Remote A r1.00	+ - No function <> Move to previous/next menu item
-----------------------------------	---

Digital Spa Software Remote B r1.00	+ - No function <> Move to previous/next menu item
--	---

CL Module Software Revision 1.00	+ - No function <> Move to previous/next menu item
-------------------------------------	---

CL Light Software + to view	+ Press to view the software revisions of detected lights <> Move to previous/next menu item
--------------------------------	---

CL LT1 Software App:1.00 BL:1.02	+ - Press to view the software revisions of detected lights <> Move to previous/next ColorLogic 4.0 light/menu item
-------------------------------------	--

*Available displays depend on configuration.* If you call the Hayward Technical Service Dept. for assistance, they may ask for the software revisions of both the main unit and each of the display/keypads or other devices that are attached to the system. Note that it is possible that different display/keypads have different software revision levels. For this reason, it is advisable to check this diagnostic menu item on every display.









**LIMITED WARRANTY (effective 03/01/12)** Hayward warrants its Pro Logic, OnCommand and E-Command pool automation products as well as its Aqua Rite, Aqua Rite Pro, Aqua Plus and SwimPure chlorination products to be free of defects in materials and workmanship, under normal use and service, for a period of three (3) years. Hayward also warrants its Aqua Trol chlorination products to be free of defects in materials and workmanship, under normal use and service for a period of one (1) year. These warranties are applicable from the initial date of purchase on private residential swimming pools in the US and Canada. Installations of product for use on commercial pools in the US and Canada is covered for a period of one (1) year for defects in materials and workmanship. Hayward warrants all accessories and replacement parts for the above-identified pool automation and chlorination products for a period of one (1) year. Accessories also include remotes, actuators, base stations, temperature sensors, flow switches and chemistry probes. Each of these warranties is not transferable and applies only to the original owner.

Hayward shall not be responsible for cartage, removal, repair or installation labor or any other such costs incurred in obtaining warranty replacements or repair.

Proof of purchase is required for warranty service. If written proof of purchase is not provided, the manufacturing date code will be the sole determinant of the date of installation of the product. To obtain warranty service or repair, please contact the place of purchase or the nearest Hayward authorized warranty service center. For more information on authorized service centers please contact the Hayward Technical Service Support Center (61 Whitecap Road, North Kingstown RI, 02852) or visit the Hayward web site at [www.hayward.com](http://www.hayward.com).

**WARRANTY EXCLUSIONS:**

1. Material supplied or workmanship performed by others in process of installation.
2. Damage resulting from improper installation including installation on pools larger than the product rating.
3. Problems resulting from failure to install, operate or maintain the product(s) in accordance with the recommendations contained in the owners manual(s).
4. Problems resulting from failure to maintain pool water chemistry in accordance with the recommendations in the owners manual(s).
5. Problems resulting from tampering, accident, abuse, negligence, unauthorized repairs or alternations, fire, flood, lightning, freezing, external water, degradation of natural stone used in or immediately adjacent to a pool or spa, war or acts of God.
6. Use of a non-genuine Hayward replacement salt chlorination cell on any Hayward automation or chlorination product will void the warranty for that product.

The express limited warranty above constitutes the entire warranty of Hayward Pool Products with respect to its products and is in lieu of all other warranties expressed or implied, including warranties of merchantability or fitness for a particular purpose. In no event shall Hayward Pool products be responsible for any consequential, special or incidental damages of any nature. Some states do not allow a limitation on how long an implied warranty lasts, or the exclusion of incidental or consequential damages, so the above limitation may not apply to you. This warranty gives you specific legal rights, and you may also have other rights, which vary from state to state.

	TEST	IDEAL RANGE	ADJUSTMENT REQUIRED
Weekly	Free Chlorine	1.0 - 3.0 ppm	Raise desired output % to increase, lower desired output % to decrease -OR- increase or decrease pump filtration time.
	pH	7.2 - 7.8	Too high - add muriatic acid Too low - add soda ash.
Monthly	Alkalinity	80 - 120 ppm	Add baking soda to increase. Add acid as required to decrease.
	Salt	2700 - 3400 ppm	Add salt as required to increase.
Quarterly	Stabilizer	60 - 80 ppm	Add cyanuric acid to increase.
	Calcium	200 - 400 ppm	Add calcium to increase. Drain and add water to decrease.
	Electrolytic Cell	inspect & clean	Refer to section in manual.

