

# MODEL 2008CE

## COMBO ENTRY with GATE

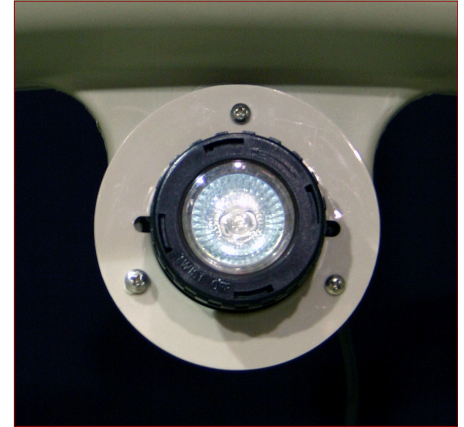

**ADD AN IN-POOL  
LIGHT TO ENHANCE  
THE POOL  
ENVIRONMENT**

### FEATURES & SPECS

- Combo step entry for easy climbing (step outside pool)
- Self-closing, self-latching & lockable gate for safety & to meet code requirements
- Adjustable from 48" to 56" with 12" top rail clearance
- Minimal obstruction in pool
- Optional 12 volt in-pool light available
- Double, extended handrails on both sides for ease of climbing
- Anti skid treads & platform for safe entry & exit
- Easy assembly
- Maintenance free resin to maintain strength & color
- Stainless steel hardware
- Can be used with our resin pool fencing to totally enclose & protect pool



**877-VINYL WK**



[www.vinylworkscanada.com](http://www.vinylworkscanada.com)

**Visit our website for further  
product information**



## **MODEL 2008CE COMBO STEP ENTRY with GATE** **FEATURES & SPECIFICATIONS**

- VINYL WORKS CANADA manufactures this Step System to meet or exceed all current code requirements for entry systems, in-pool steps, ladders and ladder enclosures
- The Model 2008CE Combo Entry System is manufactured using maintenance free resins to maintain strength & color. Stainless hardware is used for years of worry free use
- The system is designed for 300 lb capacity (one person). It is a stable entry system; ideal for every day use and easier for entry to the pool as compared to a conventional a-frame pool ladder
- The Combo Entry System is packaged in one convenient carton (two if shipping by courier)
- The Model 2008CE includes a full gate to meet requirements for enclosures. The gate is self-closing, self-latching and lockable (lock not included)
- The system utilizes double handrails for both the inpool and exterior portions for greater safety and ease of entering & exiting the pool. Clearance between handrails is 20.25". The exterior portion of the unit is entirely enclosed for protection when the pool is not in use
- All exterior step treads measure 7.5" x 20" (outside pool). This makes the system very easy to climb when entering and exiting the pool. The in-pool portion contains five treads measuring 4.75" x 18"
- The system is extremely easy to assemble, most of the components simply snap together
- The top platform spans 12" deep x 20.25" wide (inside handrails) to protect the top rail of the pool and allows for easy entry & exit of the pool. The top platform adjusts up & down to accommodate any pool wall height from 47.5" minimum to 56.25" maximum
- Minimum obstruction of swimming space ~ unit occupies only @ 10.5" within the pool (ideal for small pools)
- Smoothly rounded base allows inpool portion of entry to be stable and not damage the pool liner. A ladder or stair pad can be used for additional protection if desired (recommended - sold separately)
- The in-pool portion of the system is designed to fit close to the pool wall to prevent entrapment and allows great circulation of the pool water (both through and behind the treads)
- All treads and top platform have been designed with a non-slip surface for safe use
- The exterior risers are embossed with no diving and no jumping signs for safety reminder. As well, the entry contains all required safety signage (embossed directly into the gate at entry)
- An optional in-pool light is available for use with this entry (Model OPT12V). The 12 volt light is packaged and sold separately. It includes interchangeable colored lenses, a 10ft cable and UL listed transformer
- The Model 2008CE Combo Entry System can be used with our Pool Fence systems to totally enclose and secure your pool. Both our 24" and 36" fencing will connect to the handrail uprights by using our Connector Kits (Model CNKLS24 or CNKLS36 - sold separately)
- Each unit includes explicit installation instructions and all necessary hardware for proper assembly. Vinyl Works Canada's toll free customer service number is printed on all instruction sheets should any customer need assistance
- VINYL WORKS CANADA reserves the right to change or alter the manufacturing specifications within the specified code restrictions. If there should be any questions regarding this or any of our other products please do not hesitate to contact our customer service department at toll free 1-877-VINYL WK

**REMEMBER, NOTHING REPLACES PARENTAL SUPERVISION ~ SWIM SAFELY !**

## MODEL 2008CE - COMBO POOL ENTRY SYSTEM with GATE



**IMPORTANT INSTRUCTIONS:** Read all instructions carefully & completely to become familiar with all parts, assembly, safety and proper use of this product. Failure to follow these instructions may result in serious personal injury. **SWIM RESPONSIBLY & SAFELY !**

**TOOLS REQUIRED:** 7/16" socket, nut driver or wrench, measuring tape, Phillips (star) screwdriver, 1/4" & 1/8" drill bits & drill, pencil or marker & level. **PAD LOCK REQUIRED.**

### SAFETY INSTRUCTIONS & PROPER USE - ASSEMBLY & INSTALLATION

- This pool entry system has a 300 lb load capacity (one person) when properly assembled & installed
- Your above ground pool has shallow water - absolutely **NO DIVING** or **NO JUMPING** into the pool
- This product conforms to the latest revisions of the ANSI/APSP recommended standards for above ground / on ground swimming pool ladders / entry systems. **DO NOT** use for other purpose
- This entry is designed for use with flat bottom pools. Use of a ladder / step pad is recommended
- For entry & exit of the pool, face steps or ladder at all times. Use handrails to assist climbing
- This system is designed for use by one person only at all times
- This system is designed with a protecting gate system - **NEVER** use system without gate
- When pool is not in use, make certain gate is securely closed, latched & **LOCKED** to restrict access
- Locate entry system on a solid base and free from high traffic areas around the pool
- This entry system **MUST** be secured to top rail of pool for greater stability and safety
- Keep top platform and treads free from obstructions to avoid possible injury. Do not secure any items to the entry system. Such objects (e.g. thermometers, play toys, ropes) may create a potential for tripping or entrapment
- **NEVER ALLOW CHILDREN TO SWIM UNATTENDED** - Nothing replaces parental supervision
- Assemble and install this pool entry system as per the manufacturer's instructions. Do not deviate from these instructions

### IDENTIFY PARTS



Stainless Pins



3/4" Bolt



1" Bolt



3" Bolt



Handrail Fillers



Gate Hinges & Stop

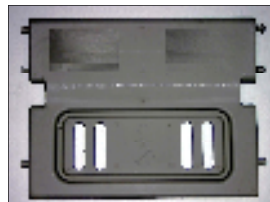

Tread-Riser - 3 pcs



Top Tread - 1 pc  
Bottom Riser - 1 pc

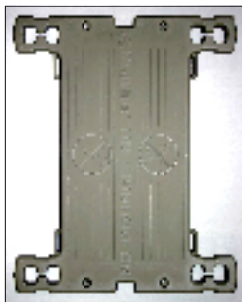

Top Platform - 1 pc

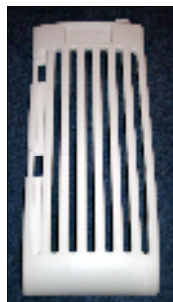

Gate - 1 pc



Ladder - 1 pc



Upper Handrails  
2-Right & 2-Left  
→  
← Lower Handrails  
1-Left & 1-Right



Stringers - 1 Left & 1 Right

### FIT TREADS & RISERS INTO STRINGERS



2.6



2.1



2.2



2.3



2.4



2.5

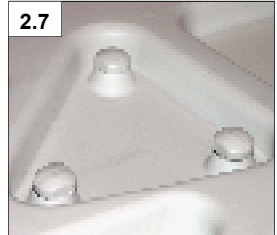

2.7

Lay stringer on flat surface with indentations to accept treads/risers facing up (as shown above in "Parts"). Fit single bottom riser into bottom indentation (2.1) & snap into place making certain the button lock tab of riser passes through hole in stringer. Fit top tread into top indentation (2.2) & snap into place. Fold tread-riser & fit into indentations above single riser (2.3). Make certain when folding that the anti-skid surface is facing upwards (2.6). Repeat for remaining two tread-risers (2.4) making certain all button lock tabs protrude & lock in place (2.7). Place opposite stringer on top of treads-risers (2.5) aligning indentations in stringer & button lock tabs with holes in stringer. Snap stringer in place locking all tabs. Double check to make certain ALL tabs protrude through holes & lock in place.

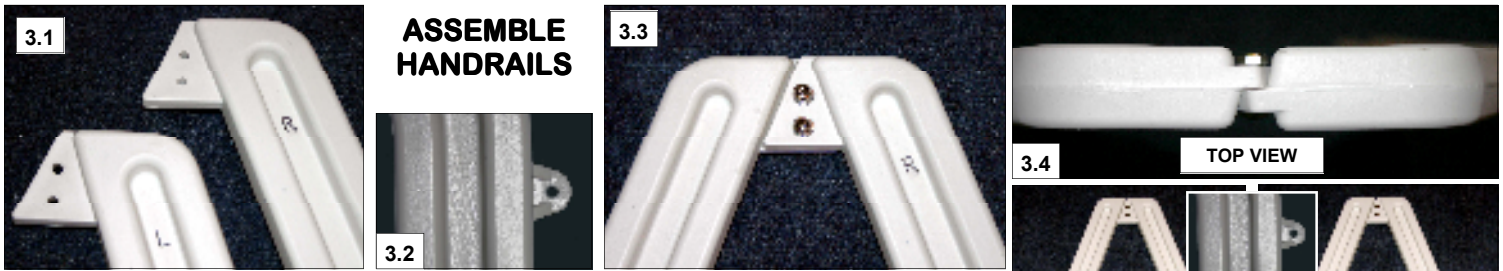

**ASSEMBLE HANDRAILS**

Identify the upper RIGHT (R) & LEFT (L) handrails (small stamp in part - as shown in 3.1). **NOTE:** one left & one right handrail have a small bolt flange molded on the side (Detail 3.2). These handrails will be used for the exterior portion with the gate (step portion - both handrails with flanges on same side of entry). Fit handrail pairs together as shown in 3.3, 3.4 & 3.5. Align bolt holes and secure using 1" bolts, washers both sides and nuts. Tighten all hardware. Repeat for both sets of upper handrails. Make certain each set of joined handrails has a bolt flange (Detail 3.5) - **DO NOT** have the handrails with bolt flanges joined together as one set.

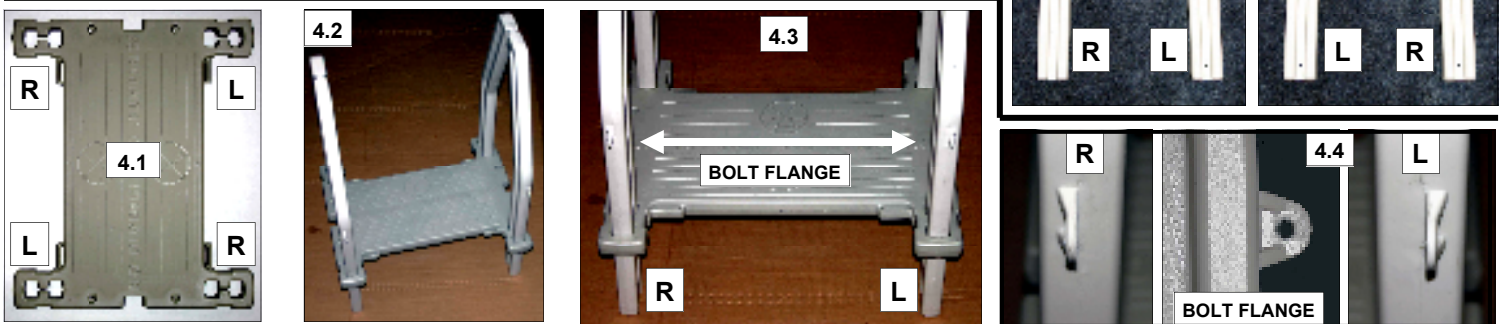

Identify top platform, and with anti-skid surface facing up, fit handrail pairs through platform as shown in 4.1 - 4.3. Repeat for both sets of upper handrail pairs on both sides of top platform. **NOTE:** the left and right handrails with the bolt flanges **MUST** be on the same side of the top platform (Detail 4.3 - 4.5) as they are used for the step portion of the entry (to connect the lower handrails). Fit assembled handrail pairs & platform into top openings of assembled step and ladder section as shown in Detail 4.5. Make certain the correct handrail fits into the appropriate hole in the step assembly and ladder. Note that the ladder has a slight angle when fitting the handrails into the open sockets (see Detail 4.6). The ladder section will angle out, away from step at bottom. This will make your ladder section inside the pool easier to climb. The ends of the handrails fit tightly into the openings at the top of each stringer and the ladder section. Make certain to push them all the way down into the opening until they bottom out. **FOR THE STEP PORTION ONLY**, align bolt holes & secure using 3/4" bolt, washers on both sides & nut. Repeat for both handrails fitting into the step. Tighten hardware. **DO NOT FASTEN HANDRAILS & LADDER SECTION UNTIL STEP 7.**

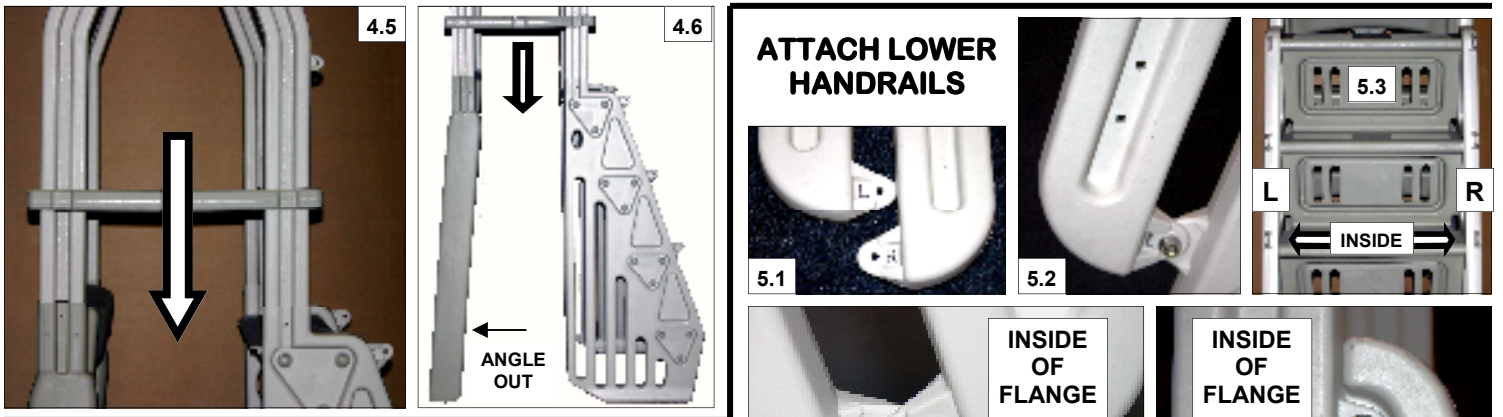

**ATTACH LOWER HANDRAILS**

Identify the RIGHT (R) & LEFT (L) lower handrails (Detail 5.1). **NOTE:** the left handrail has holes drilled in it to accept the gate hardware (see 5.2). Facing the step section, the lower left handrail attaches on the left & lower right handrail attaches on the right (5.3). Make certain the handrails are inside the three bolt flanges on the stringers and inside the bolt flanges on the upper handrails (see 5.3 - 5.5). When on the inside of the tab on upper handrail, the upper & lower handrails will be perfectly in line (see 5.6). Align holes and fasten using a 3/4" bolt, washers both sides and nut at all four locations. Tighten all hardware.

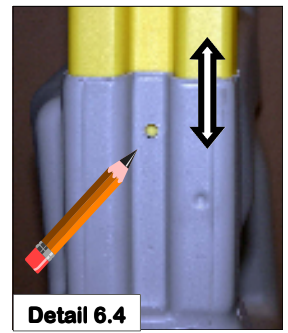
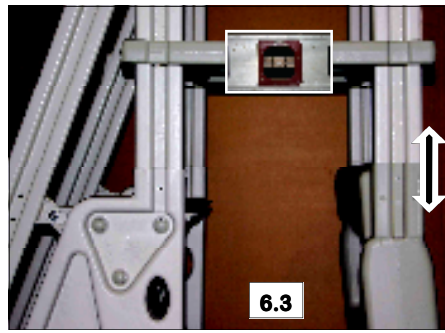
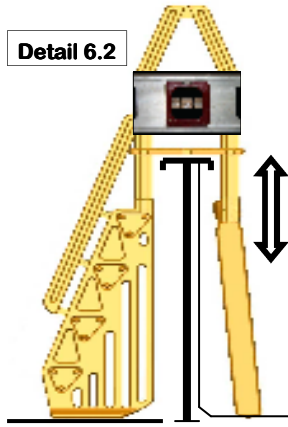
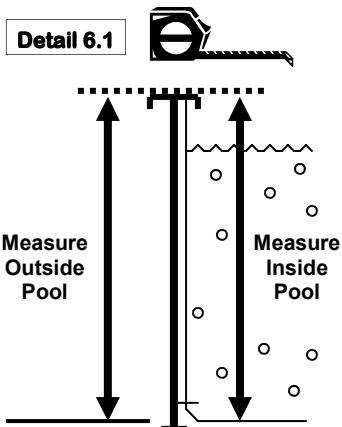

Remove entry from pool. With ladder section set to proper height adjustment, drill a 1/4" hole through both handrails at the hole locations in the side of the ladder section, at your marks (Detail 7.1). The inside face of the handrails have an open cavity to fit handrail fillers (Detail 7.2 & 7.3). Fit & slide handrail fillers down (Detail 7.4). The filler will catch over ladder section and align with holes (Detail 7.5). Secure in place using a 2" bolt & washer, for both handrails - tighten hardware.

Measure the height to the top rail of the pool, both inside & outside the pool (Detail 6.1). If the measurements are different you will need to adjust the entry system. Adjustment in height is done on the in-pool ladder section. With the upper handrails in the ladder section, move the in-pool ladder section up or down to achieve proper measurement - **IMPORTANT** that the top platform of the entry system remain level for safe entry/exit of the pool (Detail 6.2 - 6.3). If required, the handrails can be cut shorter. It is wise to place ladder over top rail & into pool to test for proper height adjustment. Make final adjustments (keeping platform level) & mark both handrails (6.4).

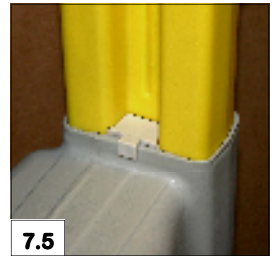
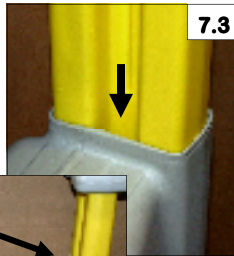
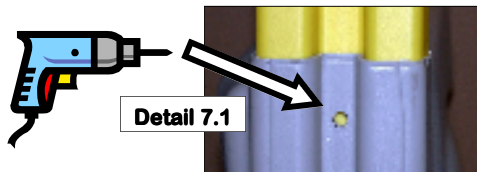

**DOUBLE CHECK ALL MEASUREMENTS BEFORE DRILLING HANDRAILS**

Place entry over pool wall at desired location. Note: it is suggested to choose a low traffic area for safety. With entry system in place (Detail 8.1) slide top platform down towards top rail of pool. Pull entry out, away from the pool so the in-pool portion is tight to the top rail (Detail 8.1 & 8.2), reducing the space between the in-pool ladder and the pool wall. This minimizes space so children cannot swim through or around ladder (potentially dangerous). With top platform approximately 1" - 2" above top rail of pool, level platform & mark all handrails where they meet the bottom of the platform (Detail 8.2). Important the top platform is level for safe entry / exit of pool.

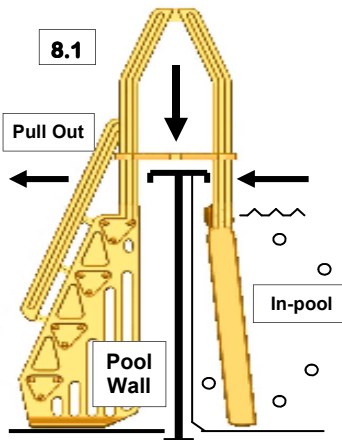

**ADJUST & MARK FOR TOP PLATFORM**

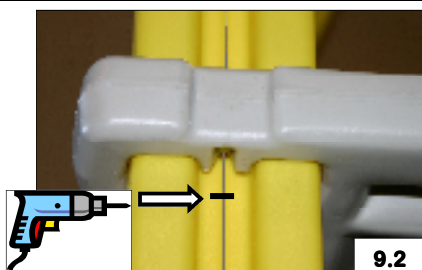
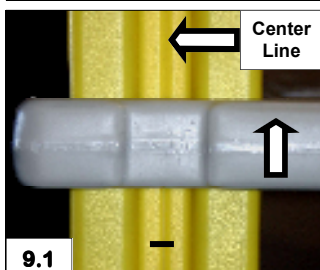
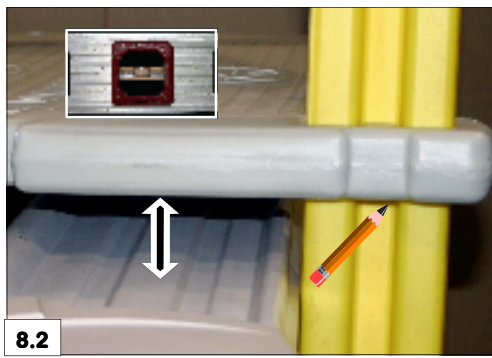

**SECURE PLATFORM**



Remove entry from pool. Raise top platform to reveal your marks on handrails (9.1). Each handrail has a center line indented in plastic - this is your guide for drilling the center of the handrail. Drill a 1/4" hole at each mark, through the handrail (9.2). Insert a stainless pin into each hole drilled, protruding equally on both sides of handrail (9.3). The top platform has locking channels at each handrail position to snap over pins & lock top platform in place securely. Push top platform down firmly, snapping & locking it over the stainless pins (9.4). Repeat for all four corners & handrails making certain all are locked into position

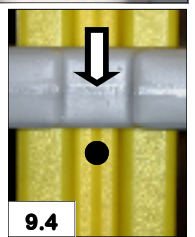

**SECURE ENTRY SYSTEM TO POOL**

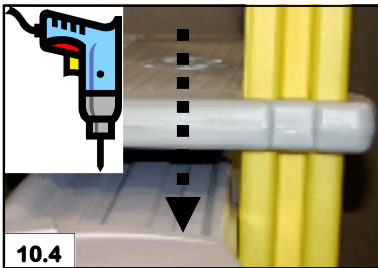
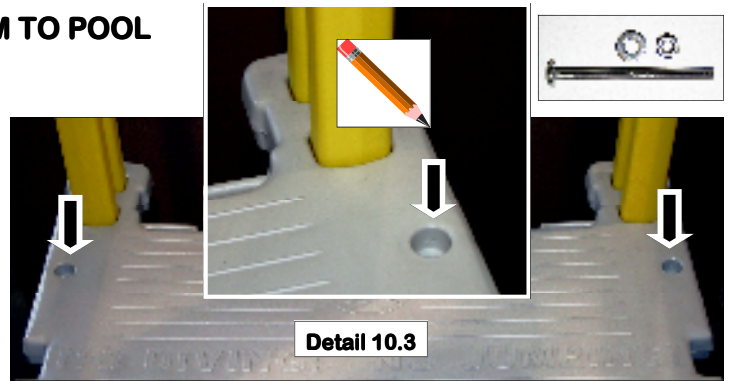
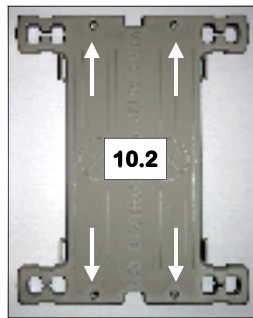
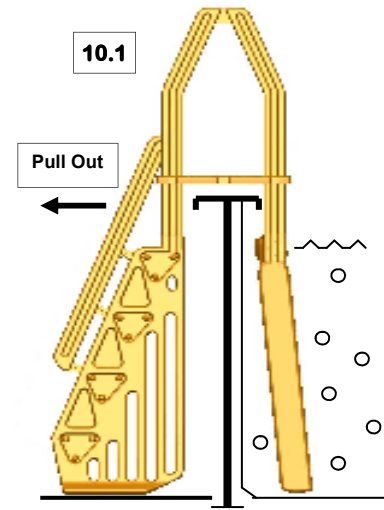

Position entry in pool at desired location (10.1). Pull entry system out, away from pool so the in-pool portion is tight to the top rail (similar to Step 8). Using two of the possible four bolt holes in top platform (10.2), mark two hole locations of top platform onto top rail of pool. Choose the two that best suit your entry positioning & top rail width (10.3). Slide entry system out of the way and, using caution, drill top rail of pool with 1/4" drill bit at marks (10.4). Keep drill shavings out of pool so they do not damage pool liner. Reposition entry & secure in place with 3" bolts, washers & nuts. Tighten to snug so entry system remains securely in place and is safe and stable to climb. Review safety instructions and proper use (from front page of this instruction) with all family members before using entry and pool. Entry system must be removed from pool when winterizing. Drain all water & store in safe place. **REMEMBER - NOTHING REPLACES PARENTAL SUPERVISION.**



**MOST IMPORTANT - NEVER USE THIS ENTRY BEFORE FIRST ATTACHING SELF CLOSING, SELF-LATCHING & LOCKABLE GATE. SEE GATE INSTRUCTION PACKAGED WITH THIS ENTRY SYSTEM. FOLLOW ALL INSTRUCTIONS CLOSELY. WHEN POOL IS NOT IN USE, CLOSE GATE AND LOCK SECURELY TO PREVENT UNWANTED ENTRY AND TO KEEP CHILDREN SAFE. NEVER LEAVE CHILDREN UNATTENDED AROUND POOL. SWIM SAFELY!**

**BE CAREFUL USING TOOLS AROUND WATER**

**ADD A LIGHT TO YOUR ENTRY SYSTEM!**

Optional  
12 VOLT  
**IN-POOL LIGHT**  
(Model OPT12V)  
Sold separately

Ask your dealer for details

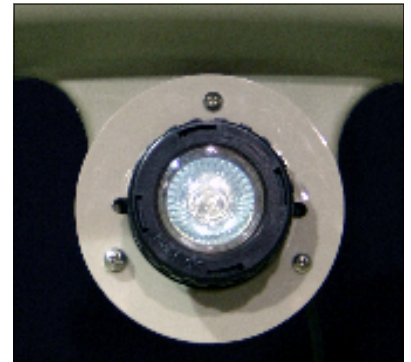

Check out our entire product line at [www.vinylworkscanada.com](http://www.vinylworkscanada.com)

Thank you for purchasing our product - please enjoy & remember, **SWIM SAFELY**

**Hardware Measurement Guide**

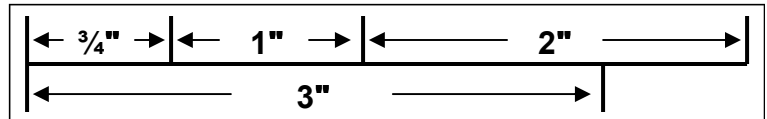

**FOR COMPLETE WARRANTY INFORMATION PLEASE VISIT OUR WEBSITE OR CALL OUR CUSTOMER SERVICE DEPARTMENT AT TOLL FREE 877-VINYL WK - ( PLEASE RETAIN ORIGINAL PROOF OF PURCHASE )**

**VINYL WORKS CANADA - 5 YEAR WARRANTY - PRODUCT REGISTRATION**

Register online at [www.vinylworkscanada.com](http://www.vinylworkscanada.com) or return completed warranty registration to:  
Vinyl Works Canada - PO Box 96, Port Colborne, Ontario, Canada L3K5V7  
( If mailing from USA international postage is required )

Owner's name: \_\_\_\_\_ Purchase date: \_\_\_\_\_ (yy/mm/dd)

Address: \_\_\_\_\_ Phone #: \_\_\_\_\_

Pool make: \_\_\_\_\_ Pool size: \_\_\_\_\_ Pool height: \_\_\_\_\_ Retailer: \_\_\_\_\_

Retailer's address: \_\_\_\_\_

Product purchased (+VWC model #): \_\_\_\_\_ Product Color: \_\_\_\_\_



## MODEL 2008GP - GATE PACKAGE for models 2008AF - 2008CE - 2008G2D Pool Entry Systems & Decks

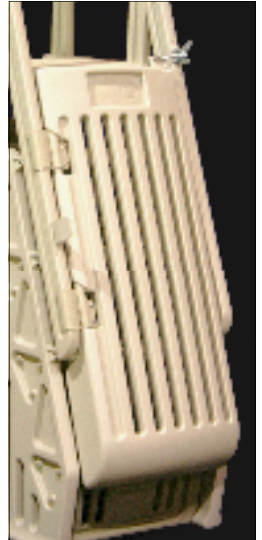

**IMPORTANT INSTRUCTIONS:** Read all instructions carefully & completely to become familiar with parts, assembly, safety and proper use of this product. Failure to follow these instructions may result in serious personal injury. **SWIM RESPONSIBLY & SAFELY!**

**TOOLS REQUIRED:** 7/16" socket - nut driver, wrench or pliers, Phillips (star) screwdriver, pencil, 1/8" drill bit & drill + a pad lock for security when the pool is not in use

### SAFETY INSTRUCTIONS & PROPER USE - ASSEMBLY & INSTALLATION

- These pool entry systems have a 300 lb load capacity - one person - when properly installed
- These entry systems are designed & intended for use with an above ground pool only (flat bottom)
- Your above ground pool has shallow water - absolutely **NO DIVING** or **NO JUMPING** into the pool
- This product conform to the latest revisions of the ANSI/APSP recommended standards for above ground/on ground swimming pool ladders
- For entry & exit of the pool, when climbing, face steps at all times. Use handrails for safe climbing
- These systems are designed for use by one person at all times
- These entry systems are designed with a protecting gate system - **NEVER** use system without gate attached & fully functional. When pool is not in use, make certain gate is securely closed, latched & locked to prevent unwanted entry
- Locate entry system on a solid base and free from high traffic areas around the pool
- Secure entry system to top rail of pool for greater stability and safety
- Keep top platform and treads free from obstructions to avoid possible injury. Do not secure any items to the entry systems. Such objects (e.g. thermometers, play toys, ropes) may create a potential for tripping or entrapment
- **NEVER ALLOW CHILDREN TO SWIM UNATTENDED** - Nothing replaces parental supervision
- Install this gate for pool entry system as per the manufacturer's instructions. Do not deviate from these instructions

### IDENTIFY PARTS

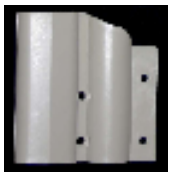

Outer Hinge  
(2 pcs)  
(large)



Inner Hinge  
(2 pcs)  
(small)

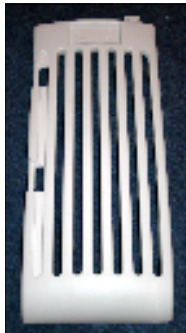

Gate - 1 pc



Gate Stop - 1 pc

The gate & gate components are packaged different for different units - make certain you have all appropriate cartons and parts to complete your chosen pool entry system or deck assembly & installation (Model 2008AF - 2008CE or 2008G2D used with SD & FD decks). Familiarize yourself with all parts and read instructions before starting assembly & installation. If you notice any parts damaged or missing please contact our customer service department for assistance @ 877-VINYL WK.

Hardware & Instructions Included

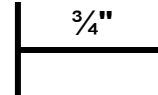

Measurement Guide



1/4" Round



3/16" Round

### POSITION HINGES & GATE STOP

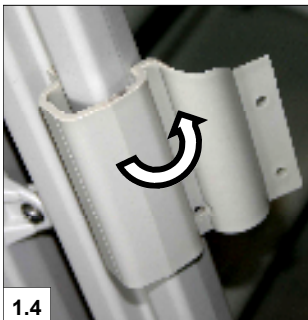
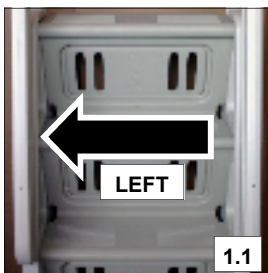
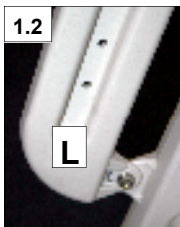

The LEFT lower handrail on the exterior portion of the entry has holes to accept the hinges & gate stop (see 1.1 & 1.2). Begin by securing the gate stop in place. Fit the stop on the outside face of the handrail over the center two holes - it is form fitting (see 1.3). Secure using two 1/4 x 3/4" bolts, washers on inside & nuts. Tighten hardware. Fit the outer hinges in place around handrail. Likewise, they are form fitting and will snap around handrail (see 1.4). The inner hinge fits on the inside of handrail and aligns with the large on the outside. Use two 1/4 x 3/4" bolts, washers & nuts on the inside face and secure LOOSELY in the back two holes, only FINGER TIGHT (see 1.5-1.7). See 1.6 & 1.7 for proper placement of parts

**READ ALL INSTRUCTIONS CAREFULLY**



2.1

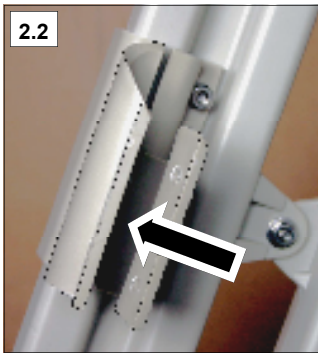

2.2

### LEAVE HINGES LOOSE WITH GAP

It is important to secure the hinge sets (inner & outer) loosely so there remains a "gap" between the parts. This gap allows you to fit the gate in place between the inner & outer hinge pairs; both top & bottom (see 2.1 - 2.3)



2.3

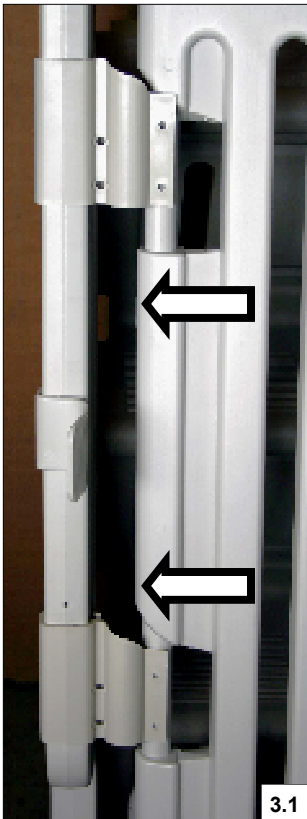

3.1

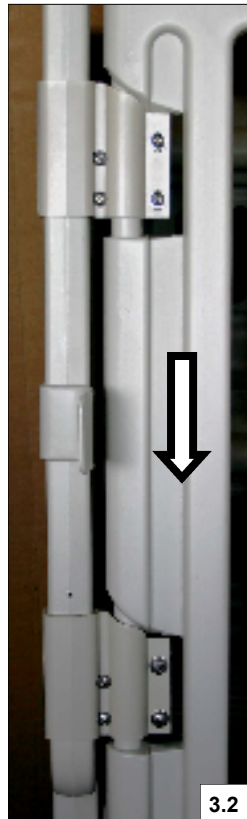

3.2

### FIT & SECURE GATE

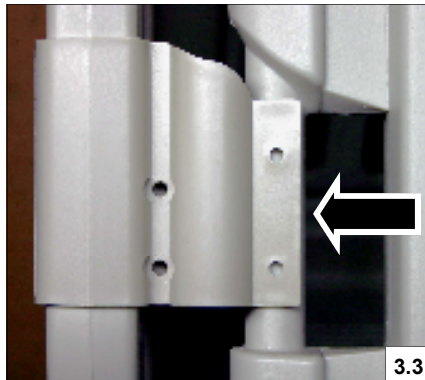

3.3

Gently pry open gate hinge sets & fit gate between the inner & outer hinge parts (3.1-3.3). The "round" posts of the gate will fit through the gap of the hinges (outlined in details above). Secure gate hinges using the remaining 1/4 x 3/4 bolts, washers & nuts. Note that the center holes only require the bolt & nut (no washers will fit). Use washers on both sides for the remaining hardware positions (3.4). Tighten all hardware & make certain gate opens and closes smoothly.

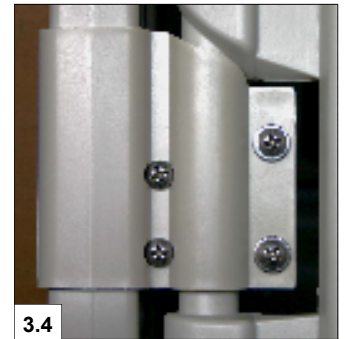

3.4

### ATTACH STRIKER & GATE LATCH

Before attaching striker & latch, be sure gate is closed and pushed DOWN within hinge sets (see 3.2 above). Attach striker to gate (see 4.1). Striker is to be outside of gate, angled appropriately. Secure with 3/16 x 3/4" bolts, washers inside & nuts. Tighten hardware. With gate closed, down entirely, & striker in latch (see 4.2), position latch in the center of handrail and mark holes with pencil. Make certain striker is centered in latch correctly & latch is closed (see 4.2 & 4.3). Pre-drill 1/8" holes & secure using #8 x 3/4" screws (see 4.4). **DO NOT** over tighten screws as plastic may strip. Test gate to be sure it operates properly. Assembly is now complete - **LOCK GATE WHEN POOL IS NOT IN USE (4.5)**



4.1

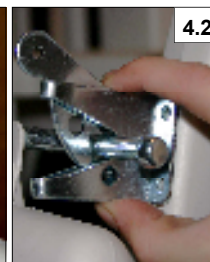

4.2

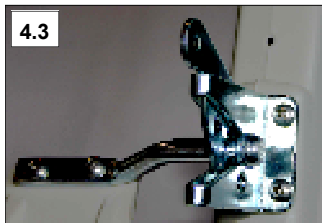

4.3



4.4



4.5



877-VINYL WK

[www.vinylworkscanada.com](http://www.vinylworkscanada.com)



Recycle Responsibly

NOTHING REPLACES PARENTAL SUPERVISION