

*Bring the Party!*

# **KOOL**

By **TUNES2GO**<sup>®</sup> **MAX**<sup>®</sup>

**40-Quart Cooler,  
Bluetooth Audio System  
and Power Station**



**Model # CA-E065A  
Instruction Manual**

**350Watts**  
**MAX**  
power output

# INDEX

Quick Start Guide.....P.2-4  
Product Diagram.....P.5-6  
Control Panel Diagram.....P.7-8  
Remote Control Guide.....P.9-10  
Input Panel Diagram.....P.10-11  
KoolMAX Accessories.....P.11  
Troubleshooting Guide.....P.12  
Warranty.....P.13  
FCC Statement.....P.14

## **Warning:**

This product is water resistant, NOT waterproof. Large amounts of water applied to this product may cause damage to major electronic components. This product is designed for light water exposure.

**DANGER:** To avoid electrical shock and damage to this product do not spray with a hose, pour water over, and/or submerge under water. This will result in damage to the electronic components and the possibility of electrical shock.

**DANGER:** The water resistant storage areas are not waterproof. They are only designed to keep your MP3 player, phone, and tablet safe from the occasional water spill. Some leakage may still occur.

**DANGER:** The front panel inputs are equipped with water resistant rubber plugs. When, and only when the rubber plugs are securely placed in the appropriate input slot, they provide water resistance.

For more information on this product's safety requirements and for questions or concerns please call (in the USA and Canada) 1-877-997-7888.

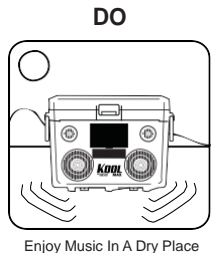
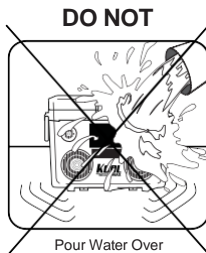
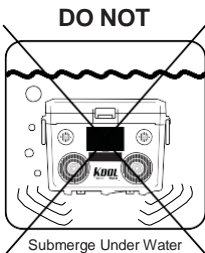

# Quick Start Guide

Please register your product at [www.sondpex.com/registration](http://www.sondpex.com/registration) for warranty and customer support

## Charging the Battery

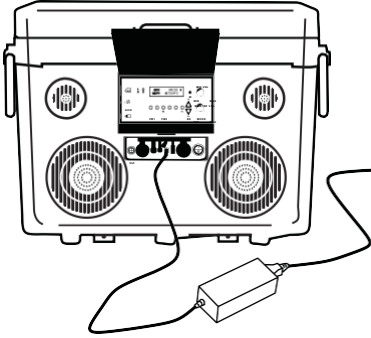

Charge battery for 24 hours before first use.

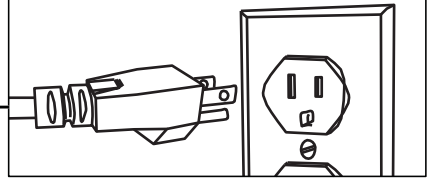

To avoid damage to battery, charge every 2-3 months, even if unit is not in use

## Battery Replacement Diagram

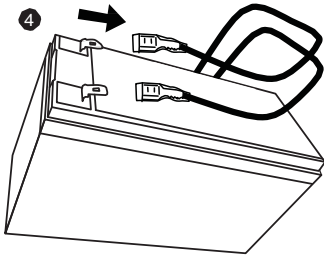
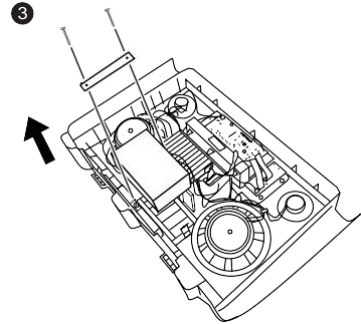
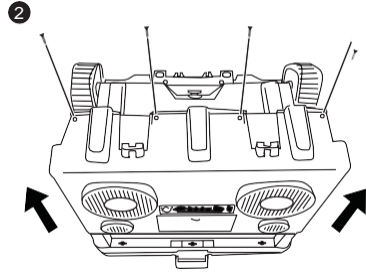
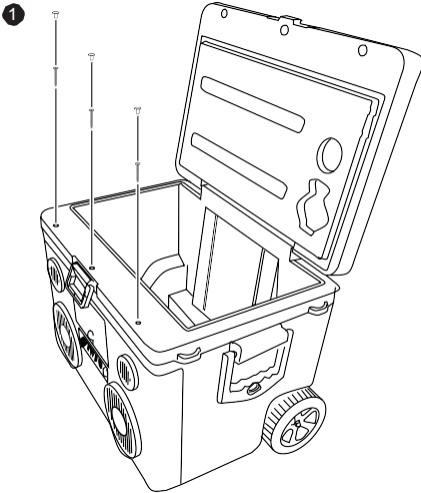

Removal:

1. Remove top 3 retaining caps and screws
2. Remove Bottom 4 retaining screws and slide the front panel upwards
3. Remove the 2 retaining screws and mounting brace
4. slide out battery and remove (+) red wire, remove (-) blue wire

Installation: Repeat steps 1-4 in reverse

## Quick Start Guide

### Music Playback



KoolMAX only supports MP3 music files for playback through its USB and SD inputs

### FM radio Reception

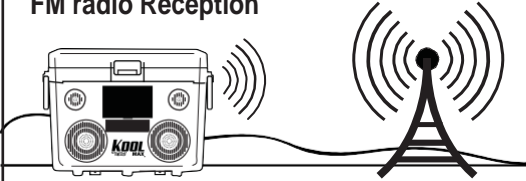

KoolMAX radio reception is based on the location and direction of cooler towards source of the signal

### Flashlight Removal and Battery Replacement

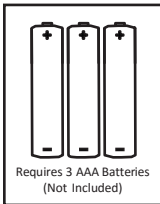
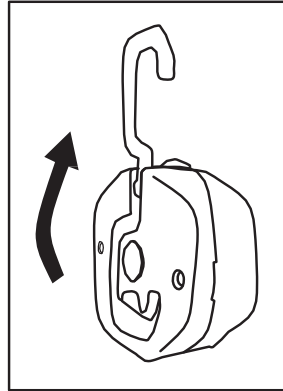
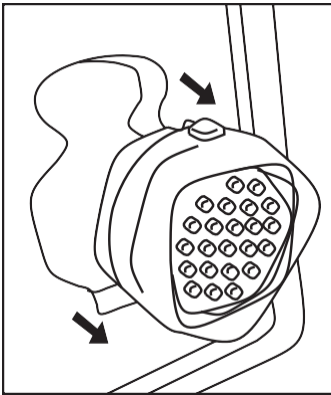

**Caution:**  
Do not mix old and new batteries.  
Do not mix alkaline, standard (carbon - zinc), or rechargeable (nickel-cadmium) batteries

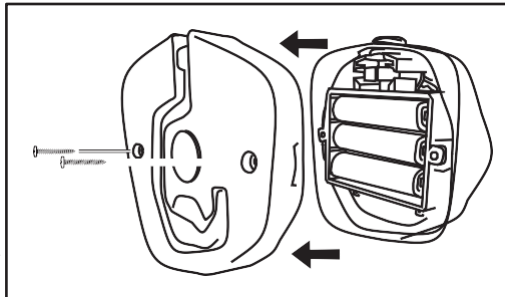

# Quick Start Guide

## Bottle Opener

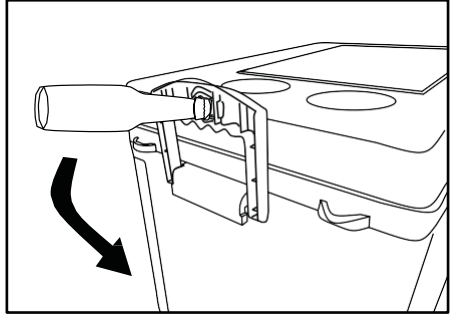
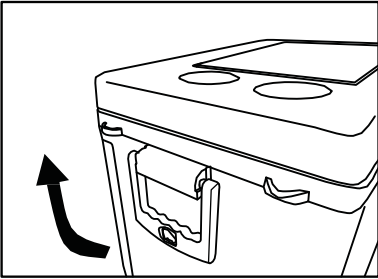

## Bungee Tie downs

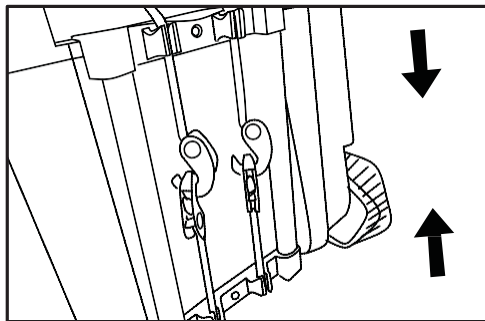
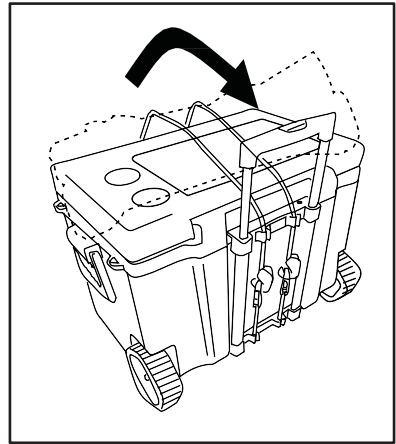
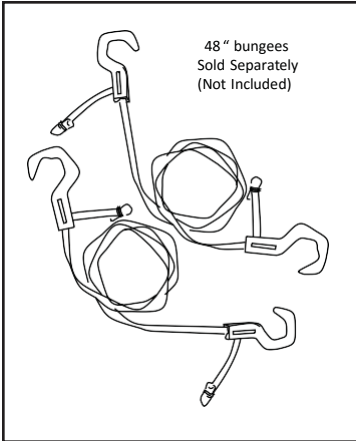

## Product Diagram

1A

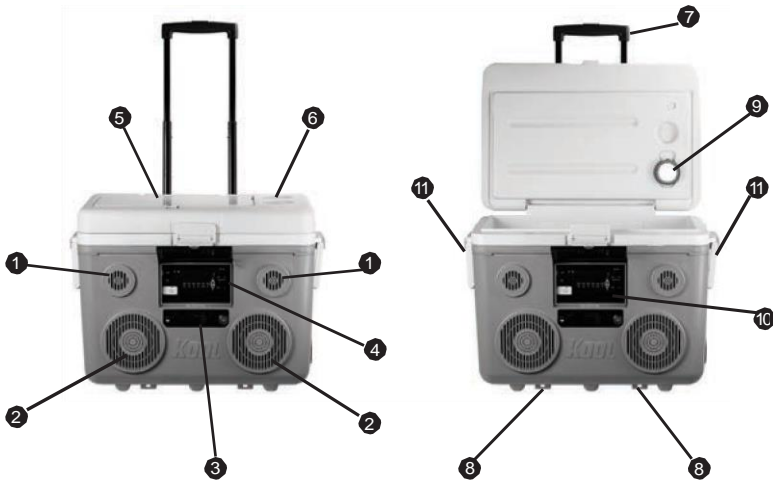

- 1. 2" Tweeters
- 2. 6.5" Speakers
- 3. Input Panel
- 4. Control Panel

- 5. iPad/Tablet Holder
- 6. Cup Holders
- 7. Telescoping Handle
- 8. Bungee Mounts

- 9. Flashlight/Holder
- 10. MP3 Player/Phone Storage
- 11. Handle/Bottle Openers

### Product Diagram 1A

#### 1. 2" Tweeters

2-water resistant 2" tweeters

#### 2. 6" Speakers

2-water resistant 6.5" high performance speakers

#### 3. Input Panel

See page 10 (Input Panel Diagram 4A)

#### 4. Control Panel

See page 7 (Control Panel Diagram 2A)

#### 5. iPad/Tablet Holder

Water resistant storage area holds iPad/tablet and the KoolMAX power charger

#### 6. Cup Holders

Holds standard size 12oz cans or bottles

#### 7. Telescoping Handle

### 8. Bungee Mounts

Mounting points for bungee cords, used to secure items to top of cooler

### 9. Flashlight/Holder

Built-in holder for the accessory flashlight (flashlight may not be included in all models)

*Note: listing of KoolMAX accessories are on Page 8*

### 10. MP3 Player/Phone Storage

Water resistant storage area holds a MP3 player or cell phone

### 11. Handle/Bottle Openers

Both handles have built-in bottle openers

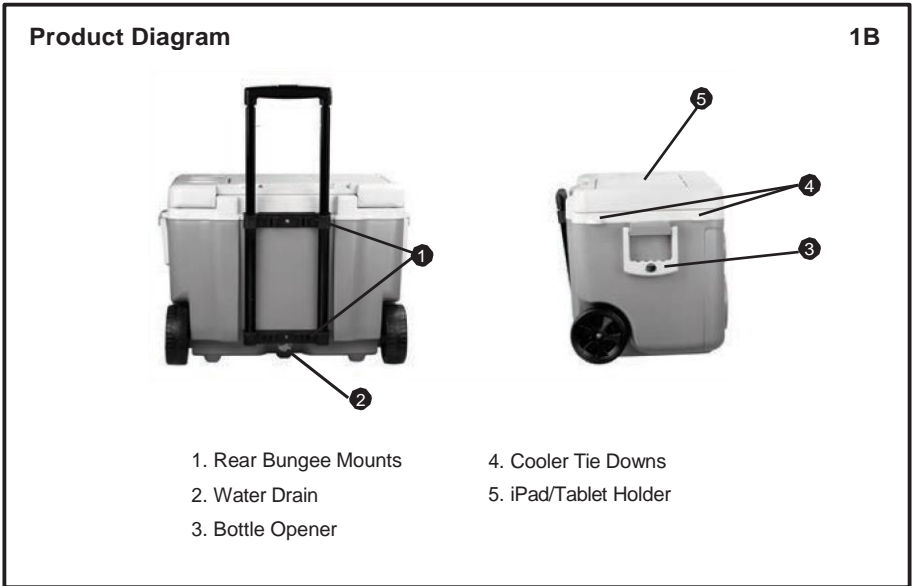

### Product Diagram 1B

#### 1. Rear Bungee Mounts

Mounting point to attach bungee cords

#### 2. Water Drain

#### 3. Bottle Opener

#### 4. Cooler Tie Downs

There are a total of 4 cooler tie down points

#### 5. iPad/Tablet Holder

Water resistant storage area holds iPad/tablet and the KoolMAX power charger

## Control Panel Diagram

2A

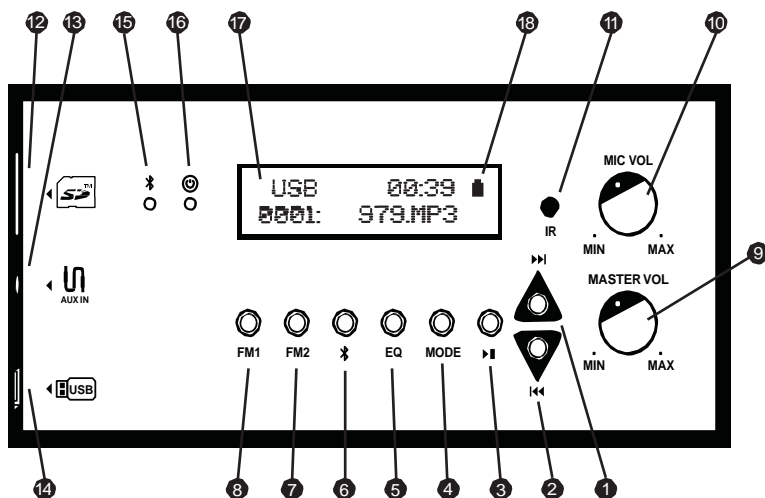

- |               |                  |                          |
|---------------|------------------|--------------------------|
| 1. NEXT       | 7. FM2           | 13. AUX IN               |
| 2. PREV       | 8. FM1           | 14. USB In/Charging Port |
| 3. PLAY/PAUSE | 9. MASTER VOL    | 15. Bluetooth LED        |
| 4. MODE       | 10. MIC VOL      | 16. Dual LED             |
| 5. EQ         | 11. IR Receiver  | 17. LCD Display          |
| 6. Bluetooth  | 12. SD Card Slot | 18. Battery Icon         |

### Control Panel 2A

#### 1. NEXT

In USB/SD/Bluetooth mode, press the key to skip to the next song.

In FM radio mode, press the key to select the next radio station. For manual FM station tuning, press the key to increase the frequency (step frequency 0.1MHz). Press and hold this key to enter seek mode, which will stop at the first radio station that is found.

#### 2. PREV

In USB/SD/Bluetooth mode, press the key to skip to the previous song.

In FM radio mode, press the key to select the previous radio station. For manual FM station tuning, press the key to decrease the frequency (step frequency 0.1MHz). Press and hold this key to enter seek mode, which will stop at the first radio station that is found.

#### 3. PLAY/PAUSE

In USB/SD/Bluetooth mode, press the key to play/pause.

In radio mode, press and hold the key to enter automatic seek mode over the entire frequency range. In radio mode, press the key to enter the manual searching mode. The frequency displayed on the screen will start flashing. After this happens, press the "NEXT" or "PREV" key to increase or decrease the frequency. If there is no action within 15 seconds, the displayed frequency will stop flashing.



#### **4. MODE**

Toggles audio source. Press this key to toggle the audio source in this order:  
USB→SD→FM→AUX

#### **5. EQ**

Toggles EQ mode. Press this key to toggle the EQ mode in this order:  
NORMAL-BASS-POP-ROCK-JAZZ-COUNTRY

#### **6. Bluetooth**

Shortcut key for Bluetooth mode. Press this at any time to switch to Bluetooth mode.  
Each time the KoolMAX is powered on, it defaults to Bluetooth mode.

#### **7. FM2**

In FM mode, press this key, then press the "NEXT" or "PREV" key to toggle between the 6 FM stations stored in FM2. In manual tuning and seek modes, press the key to store the current station in FM2. FM2 can store 6 stations at one time. If the number of stored stations is more than 6, the earliest stored station will be overwritten.

#### **8. FM1**

In FM mode, press this key, then press the "NEXT" or "PREV" key to toggle between the 6 FM stations stored in FM1. In manual tuning and seek modes, press the key to store the current station in FM1. FM1 can store 6 stations at one time. If the number of stored stations is more than 6, the earliest stored station will be overwritten.

#### **9. MASTER VOL**

Master volume control knob. Clockwise rotation increases volume, counter clockwise rotation decreases volume.

#### **10. MIC VOL**

Microphone volume control knob. Clockwise rotation increases volume, counter clockwise rotation decreases volume.

#### **11. IR Remote Control Receiver**

#### **12. SD Card Slot**

#### **13. AUX IN**

#### **14. USB In/Charging Port**

#### **15. Bluetooth LED**

Blue LED indicator light. Only turns on when in Bluetooth mode.

#### **16. Dual LED**

Dual LED Indicator System

**Green LED:** Turns on when KoolMAX is powered on

**Red LED:** Turns on when the battery is charging (regardless if KoolMAX is powered on or not). When the battery is fully charged, the red LED will turn off.













#### **17. LCD Display**

#### **18. Battery icon**

Indication of battery power

## Remote Control Guide

3A

- |   |   |
|---|---|
|  Power         |  NEXT          |
|  STOP          |  PREV          |
|  Mute          |  PLAY/PAUSE    |
|  MODE          |  V+            |
|  EQ            |  V-            |
|  Playback Mode |  1 Number Keys |

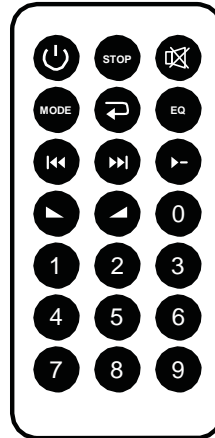

### Remote Control Guide 3A

#### Power

System power on/off

#### STOP

In USB/SD mode, press this key to stop the track that is currently played. If the PLAY/PAUSE button is pressed again, KoolMAX will play the track from the beginning.

#### MUTE

#### MODE

Audio source selection key. Press this key to toggle the audio source in this order: USB→SD→FM→AUX

#### Playback Mode

Toggles USB/SD playback modes. Press this key to toggle the playback mode in this order: ALL (all tracks in a continuous loop), RANDOM (random playback), ONE (single tracks in a continuous loop), FOLDER (only tracks in the current folder in a continuous loop). When KoolMAX is powered on, it defaults to the ALL playback mode.

#### EQ

Toggles EQ mode. Press this key to toggle the EQ mode in this order: NORMAL-BASS-POP-ROCK-JAZZ-COUNTRY

#### NEXT

In USB/SD/Bluetooth mode, press the key to skip to the next song.  
In FM radio mode, press the key to select the next radio station.

**PREV**

In USB/SD/Bluetooth mode, press the key to skip to the previous song.  
 In FM radio mode, press the key to select the previous radio station.

**PLAY/PAUSE**

In USB/SD/Bluetooth playing mode, press the key to play/pause.

**V+**

Increases volume

**V-**

Decreases volume

**Number Keys:**

In USB/SD mode, use the digital keys to directly select a track number.

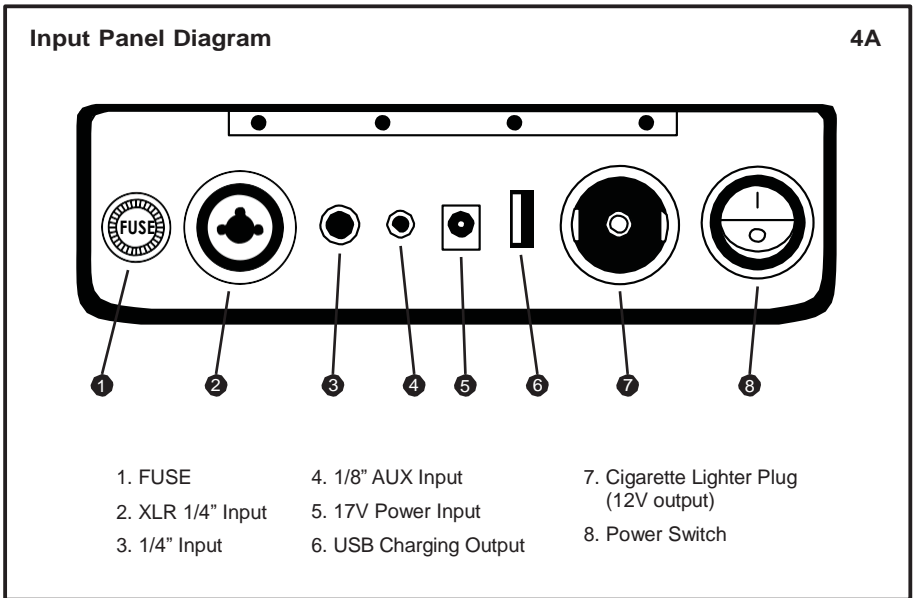
**Input Panel Diagram 4A****1. FUSE**

5x20mm, T5A/250V glass fuse

**2. XLR 1/4" Input**

Microphone and instrument input

**3. 1/4" Input**

Instrument input

**4. 1/8" AUX Input**

Used to connect to any device with an AUX port

**5. 17V Power Input**

Note: Only charge the KoolMAX with 100-240V AC/17V DC power adapter

**6. USB Charging Output**

5.2A output charges devices like cell phones, laptops, and tablets

**7. Cigarette Lighter Plug (12V output)**

12V output powers devices like fans, lights, and air pumps

**8. Power Switch**

**Optional KoolMAX Accessories**



KoolMAX 12V Air Pump



KoolMAX 12V Fan



KoolMAX LED Light



KoolMAX Super Ice Packs



KoolMAX Portable Solar Charging Kit



KoolMAX Divider



KoolMAX Bungee Cords



KoolMAX Cigarette Adaptor (DC17V/USB)

Visit [www.sondpex.com/Koolmax](http://www.sondpex.com/Koolmax) to order accessories and replacement parts.

# Troubleshooting Guide

Issues	Possible Causes	Solutions
Unit not powering On	Battery is low on power	Plug in unit to wall outlet, let unit charge for 24 hours
	Fuse is burnt out	Use a replacement fuse with the appropriate size and rating
No sound	It is muted or the volume is at zero	Adjust the volume to your required level
	Are Input Device is improperly connected	Check the device input and make sure plugs are properly connected
No sound while using USB or SD card	Incorrect file format	Check if media files are MP3 file format
Incorrectly reading USB or SD card	Error or not recognizing the media	Remove and re-insert, check if media files are MP3 file format
Audio Distortion	Volume level too high	Lower the volume to a comfortable level
	EQ might not be on the appropriate setting for the music type	Change EQ setting to the appropriate music type
Poor tuner reception	KoolMAX might not be positioned toward radio signal	Move the unit to a new position.
	Weak signal	Change to another station
Unit is freezing	Not responsive	Turn off the unit, and power it on again Battery is low try changing unit for 24 hours

Please register your product at  
**www.sondpex.com/registration**  
for warranty and customer support

## **One Year LIMITED WARRANTY**

KoolMAX Model # CA-E065A

This warranty is provided to you by Sondpex Corp. of America,  
and is applicable to this Sondpex product with the following exceptions:

- When the product was used for purposes other than the ones it is intended for
- If the product was operated contrary to the instructions provided in this manual
  - If the product has been altered or repaired by unauthorized parties

## **WARRANTY**

Sondpex warrants this product against original defects in materials  
or workmanship for a period of one year after the original purchase date.

Our sole obligations under this warranty are to replace defective products  
without charge or to provide a refund. Conditions or damages caused by  
accidents, alterations, misuse, or failure to follow instructions for installation, are excluded  
from this warranty. Normal wear and tear are not covered by this warranty.

Date of purchase:    /    /    \_\_\_\_\_

## **SERVICE**

If you believe your product is defective, please contact Sondpex at the  
number listed below. Do not return the product to the place of purchase  
without first contacting Sondpex. If you need any other assistance,  
please contact Sondpex at the telephone number provided below.

Toll free (USA and Canada): 1-877-997-7888

support@sondpex.com

www.sondpex.com

Sondpex Corp. of America

Princeton, NJ 08540 USA

## **FCC STATEMENT**

This device complies with Part 15 of the FCC Rules. Operation is subject to the following two conditions:

- (1) this device may not cause harmful interference, and
- (2) this device must accept any interference received, including interference that may cause undesired operation.

Warning: Changes or modifications to this unit not expressly approved by the party responsible for compliance could void the user's authority to operate the equipment.

NOTE: This equipment has been tested and found to comply with the limits for a Class B digital device, pursuant to Part 15 of the FCC Rules. These limits are designed to provide reasonable protection against harmful interference in a residential installation. This equipment generates, uses and can radiate radio frequency energy and, if not installed and used in accordance with the instructions, may cause harmful interference to radio communications. However, there is no guarantee that interference will not occur in a particular installation. If this equipment does cause harmful interference to radio or television reception, which can be determined by turning the equipment off and on, the user is encouraged to try to correct the interference by one or more of the following measures:

Reorient or relocate the receiving antenna.

Increase the separation between the equipment and receiver.

Connect the equipment into an outlet on a circuit different from that to which the receiver is connected.

Consult the dealer or an experienced radio/TV technician for help.

*Bring the Party!*

# **KOOL**

By **TUNES2GO** **MAX**

[www.sondpex.com](http://www.sondpex.com)

Toll Free (USA and Canada)

1-877-997-7888

Sondpex Corp. of America

Princeton, NJ08540, USA