



INGROUND LINER MEASURING FORM

Ver. 21.01.01

DISTRIBUTOR INFORMATION

NAME:	
LOCATION:	
CONTACT:	
EMAIL:	

CUSTOMER TAG NAME:

SHIP TO ADDRESS

CHECK ONE

<input type="checkbox"/> QUOTE ONLY	<input type="checkbox"/> ORDER
ORDER INFORMATION	
QUOTE#:	SO#:
PO #:	<input type="checkbox"/> SIGN OFF REQUESTED

DEALER INFORMATION

NAME:	S45 ID #:
CITY/STATE:	EMAIL:

EXTENDED WARRANTY PROGRAM

<input type="checkbox"/> GOLD (\$1,500 & 5 YRS WATER & LABOR)	<input type="checkbox"/> SILVER (\$1,000 & 4 YRS WATER & LABOR)
---	---

BASIC LINER INFORMATION

<input type="checkbox"/> BEADED (IF NOT STANDARD BEAD, WHAT TYPE: (_____))	<input type="checkbox"/> OVERLAP (HOW MANY INCHES OF OVERLAP: _____INCHES
FIBERGLASS STAIRS: <input type="checkbox"/> YES <input type="checkbox"/> NO IF YES, <input type="checkbox"/> STRAIGHT <input type="checkbox"/> RADIUS DRAW LOCATION ON SHAPE MEASURING FORM.	VINYL COVERED STAIRS OR BENCH <input type="checkbox"/> YES <input type="checkbox"/> NO IF YES, PROVIDE ACCOMPANYING STEP FORM AND DRAW LOCATION ON SHAPE MEASURING FORM.

NOTE: COMPLETE MEASURING FORM MUST INCLUDE THIS COVER SHEET, PLUS SHAPE MEASURING FORM. A STEP MEASURING FORM MUST BE INCLUDED WHERE APPLICABLE.

PATTERN SELECTION

WRITE IN (BELOW)

SELECT PATTERN FROM FULL LISTING (PAGE 3)

LINER INFO	PRIMARY MATERIAL SELECTION	ALTERNATE MATERIAL SELECTION #1	ALTERNATE MATERIAL SELECTION #2
PATTERN NAME:			
FLOOR NAME:			
MIL:	<input type="checkbox"/> 20 MIL <input type="checkbox"/> 28 MIL <input type="checkbox"/> 28/20 MIL	<input type="checkbox"/> 20 MIL <input type="checkbox"/> 28 MIL <input type="checkbox"/> 28/20 MIL	<input type="checkbox"/> 20 MIL <input type="checkbox"/> 28 MIL <input type="checkbox"/> 28/20 MIL

I AUTHORIZE GLI TO ENTER THE ALTERNATE MATERIAL SELECTIONS WHEN THE PRIMARY SELECTION IS NOT AVAILABLE.

_____ CHECK BOX & INIT.

NON-STANDARD PATTERN SELECTION: SEE PAGE 4 & PROVIDE ALL REQUIRED INFORMATION.

COLORMAGIC™ POOL FIXTURES

INSERT QUANTITY REQUIRED IN THE SELECTED COLOR(S):

ITEM DESCRIPTION	PART #	DEFAULT COLOR	BEIGE (06-BGE)	LIGHT GRAY (03-GRY)	DARK GRAY (05-DKG)	LIGHT BLUE (09-BLU)	DARK BLUE (07-DKB)	WHITE (01-WHT)	CLEAR (CLR)
VINYL TOP MAIN DRAIN COVER	VTDC								
BEAUTY RING EYEBALL FITTING	BR								

SKIMMER BEAUTY KIT ITEMS:

NOTE: TO MAKE A COMPLETE SKIMMER BEAUTY KIT BE SURE TO SELECT A SKIMMER FACEPLATE, DECORATIVE INSERT & SKIMMER WEIR FROM THE BELOW OPTIONS.

ITEM DESCRIPTION	PART #	DEFAULT COLOR	BEIGE (06-BGE)	LIGHT GRAY (03-GRY)	DARK GRAY (05-DKG)	LIGHT BLUE (09-BLU)	DARK BLUE (07-DKB)	WHITE (01-WHT)	CLEAR (CLR)
SMALL SP1084 SKIMMER FACEPLATE	SFP								
SMALL SP1084 - LIMITED AVAILABILITY SKIMMER DECORATIVE INSERT	SSI								
LARGE SP1085-10M & LARGE SP1085-20M SKIMMER FACEPLATE	LFP								
LARGE SP1085-10M 12 ^{1/4} " - LIMITED AVAILABILITY SKIMMER DECORATIVE INSERT	LSI								
LARGE SP1085-20M 9 ^{1/4} " - LIMITED QUANTITIES SKIMMER DECORATIVE INSERT	LSIS								
SKIMMER WEIR (FITS SP1084, SP1085-10M, SP1085-20M) - LIMITED AVAILABILITY	SW								

NOTE: BY NOT SELECTING A PATTERN AND/OR MIL YOU MAY DELAY THE LINER LEAD TIME.

PRIMARY MATERIAL SELECTION

I AUTHORIZE GLI TO ENTER THE ALTERNATE MATERIAL SELECTIONS WHEN THE PRIMARY SELECTION IS NOT AVAILABLE.

_____ CHECK BOX & INIT.

CUSTOMER TAG NAME:		ORDER INFORMATION	
		QUOTE #:	SO#:
			PO#:
STANDARD LINER PATTERN SELECTION		STANDARD LINER PATTERN SELECTION	
STANDARD PATTERN	MIL SELECTION	STANDARD PATTERN	MIL SELECTION
DESTINATION SERIES		SIGNATURE PLUS SERIES	
BARI	<input type="checkbox"/> 28 MIL	WHITEHAVEN	<input type="checkbox"/> 28/28 MIL
BISCAY	<input type="checkbox"/> 28 MIL	MODESTO	<input type="checkbox"/> 28/28 MIL
BLUE HAMPTON	<input type="checkbox"/> 20 MIL <input type="checkbox"/> 28 MIL	OCEAN BEACH	<input type="checkbox"/> 28/28 MIL
BLUE RALEIGH	<input type="checkbox"/> 20 MIL <input type="checkbox"/> 28 MIL	ST. GEORGE	<input type="checkbox"/> 28/28 MIL
BREAKING SEAWALL	<input type="checkbox"/> 28 MIL	ST. BARTS	<input type="checkbox"/> 28/28 MIL
DURANGO	<input type="checkbox"/> 28 MIL	LAGUNA	<input type="checkbox"/> 28/28 MIL
FALLING ESAGONO	<input type="checkbox"/> 28 MIL	CAYMAN	<input type="checkbox"/> 28/28 MIL
FLAGSTONE GRAY	<input type="checkbox"/> 28 MIL	MARCO ISLAND	<input type="checkbox"/> 28/28 MIL
FLAGSTONE TAN	<input type="checkbox"/> 28 MIL	SANTA BARBARA	<input type="checkbox"/> 28/28 MIL
GALLIO	<input type="checkbox"/> 28 MIL	MALIBU	<input type="checkbox"/> 28/28 MIL
ISLAND WAVE	<input type="checkbox"/> 20 MIL <input type="checkbox"/> 28 MIL	FULL FLOOR (FF) PATTERN SELECTION	
LEON	<input type="checkbox"/> 28 MIL	NO TILE BORDER PATTERNS ONLY!	
MESA	<input type="checkbox"/> 20 MIL <input type="checkbox"/> 28 MIL	FF PATTERN	MIL
MIDNIGHT OCEAN	<input type="checkbox"/> 20 MIL <input type="checkbox"/> 28 MIL	AQUARIUS	<input type="checkbox"/> 20 MIL <input type="checkbox"/> 28 MIL
MONTERREY	<input type="checkbox"/> 20 MIL <input type="checkbox"/> 28 MIL	AQUARIUS HD	<input type="checkbox"/> 28 MIL
MOUNTAIN MOSAIC	<input type="checkbox"/> 20 MIL <input type="checkbox"/> 28 MIL	AURORA	<input type="checkbox"/> 20 MIL
NERO	<input type="checkbox"/> 28 MIL	BEACH PEBBLE BLUE	<input type="checkbox"/> 20 MIL <input type="checkbox"/> 28 MIL
OXFORD	<input type="checkbox"/> 28 MIL	BLUE BONAIR	<input type="checkbox"/> 28 MIL
SAVANNAH	<input type="checkbox"/> 20 MIL <input type="checkbox"/> 28 MIL	BLUE CRYSTAL	<input type="checkbox"/> 20 MIL <input type="checkbox"/> 28 MIL
SCOTTSDALE	<input type="checkbox"/> 20 MIL <input type="checkbox"/> 28 MIL	BLUE OPAL	<input type="checkbox"/> 28 MIL
SEDONA	<input type="checkbox"/> 20 MIL <input type="checkbox"/> 28 MIL	INDIGO ARCTIC HD	<input type="checkbox"/> 20 MIL
SIGNATURE SERIES		COBBLESTONE	<input type="checkbox"/> 20 MIL <input type="checkbox"/> 28 MIL
CARNEGIE INDIGO	<input type="checkbox"/> 28/20 MIL	CRYSTAL QUARTZ	<input type="checkbox"/> 28 MIL
BLUE CABO	<input type="checkbox"/> 28/20 MIL	ECLIPSE AMBER	<input type="checkbox"/> 28 MIL
LOS CABOS	<input type="checkbox"/> 28/20 MIL	GRAY BONAIR	<input type="checkbox"/> 28 MIL
MADISON	<input type="checkbox"/> 28/20 MIL	GRAY CRYSTAL	<input type="checkbox"/> 28 MIL
SOUTH BEACH	<input type="checkbox"/> 28/20 MIL	GRAY OPAL	<input type="checkbox"/> 28 MIL
SHIMMER STONE FOR DESTINATION SERIES		GUNITE LIGHT BLUE	<input type="checkbox"/> 20 MIL <input type="checkbox"/> 28 MIL
ESAGONO	<input type="checkbox"/> 28 MIL	MOSAIC DARK GRAY	<input type="checkbox"/> 28 MIL
IVY INDIGO	<input type="checkbox"/> 20 MIL <input type="checkbox"/> 28 MIL	MOSAIC LIGHT BLUE	<input type="checkbox"/> 20 MIL <input type="checkbox"/> 28 MIL
PEARLSTONE	<input type="checkbox"/> 28 MIL	MYSTIC LIGHT BLUE	<input type="checkbox"/> 28 MIL
OBSIDIAN	<input type="checkbox"/> 28 MIL	POLYNESIAN	<input type="checkbox"/> 28 MIL
BLUE SLATE	<input type="checkbox"/> 28 MIL	ROYAL AMBER	<input type="checkbox"/> 28 MIL
FLOORTEX SERIES		SAND GUNITE	<input type="checkbox"/> 20 MIL <input type="checkbox"/> 28 MIL
MOUNT GRIS	<input type="checkbox"/> 28 MIL	SANDSTONE TAN	<input type="checkbox"/> 20 MIL <input type="checkbox"/> 28 MIL
MOUNT BLEU	<input type="checkbox"/> 28 MIL	SLATE	<input type="checkbox"/> 28 MIL
		TERRAZO CARIBBEAN	<input type="checkbox"/> 20 MIL <input type="checkbox"/> 28 MIL
		TERRAZO ICE	<input type="checkbox"/> 20 MIL <input type="checkbox"/> 28 MIL
		WHITE PACIFIC	<input type="checkbox"/> 28 MIL

ALTERNATE MATERIAL SELECTION #1

I AUTHORIZE GLI TO ENTER THE ALTERNATE MATERIAL SELECTIONS WHEN THE PRIMARY SELECTION IS NOT AVAILABLE.

_____ CHECK BOX & INIT.

CUSTOMER TAG NAME:		ORDER INFORMATION	
		QUOTE #:	SO#:
			PO#:
STANDARD LINER PATTERN SELECTION		STANDARD LINER PATTERN SELECTION	
STANDARD PATTERN	MIL SELECTION	STANDARD PATTERN	MIL SELECTION
DESTINATION SERIES		SIGNATURE PLUS SERIES	
BARI	<input type="checkbox"/> 28 MIL	WHITEHAVEN	<input type="checkbox"/> 28/28 MIL
BISCAY	<input type="checkbox"/> 28 MIL	MODESTO	<input type="checkbox"/> 28/28 MIL
BLUE HAMPTON	<input type="checkbox"/> 20 MIL <input type="checkbox"/> 28 MIL	OCEAN BEACH	<input type="checkbox"/> 28/28 MIL
BLUE RALEIGH	<input type="checkbox"/> 20 MIL <input type="checkbox"/> 28 MIL	ST. GEORGE	<input type="checkbox"/> 28/28 MIL
BREAKING SEAWALL	<input type="checkbox"/> 28 MIL	ST. BARTS	<input type="checkbox"/> 28/28 MIL
DURANGO	<input type="checkbox"/> 28 MIL	LAGUNA	<input type="checkbox"/> 28/28 MIL
FALLING ESAGONO	<input type="checkbox"/> 28 MIL	CAYMAN	<input type="checkbox"/> 28/28 MIL
FLAGSTONE GRAY	<input type="checkbox"/> 28 MIL	MARCO ISLAND	<input type="checkbox"/> 28/28 MIL
FLAGSTONE TAN	<input type="checkbox"/> 28 MIL	SANTA BARBARA	<input type="checkbox"/> 28/28 MIL
GALLIO	<input type="checkbox"/> 28 MIL	MALIBU	<input type="checkbox"/> 28/28 MIL
ISLAND WAVE	<input type="checkbox"/> 20 MIL <input type="checkbox"/> 28 MIL	FULL FLOOR (FF) PATTERN SELECTION	
LEON	<input type="checkbox"/> 28 MIL	NO TILE BORDER PATTERNS ONLY!	
MESA	<input type="checkbox"/> 20 MIL <input type="checkbox"/> 28 MIL	FF PATTERN	MIL
MIDNIGHT OCEAN	<input type="checkbox"/> 20 MIL <input type="checkbox"/> 28 MIL	AQUARIUS	<input type="checkbox"/> 20 MIL <input type="checkbox"/> 28 MIL
MONTERREY	<input type="checkbox"/> 20 MIL <input type="checkbox"/> 28 MIL	AQUARIUS HD	<input type="checkbox"/> 28 MIL
MOUNTAIN MOSAIC	<input type="checkbox"/> 20 MIL <input type="checkbox"/> 28 MIL	AURORA	<input type="checkbox"/> 20 MIL
NERO	<input type="checkbox"/> 28 MIL	BEACH PEBBLE BLUE	<input type="checkbox"/> 20 MIL <input type="checkbox"/> 28 MIL
OXFORD	<input type="checkbox"/> 28 MIL	BLUE BONAIR	<input type="checkbox"/> 28 MIL
SAVANNAH	<input type="checkbox"/> 20 MIL <input type="checkbox"/> 28 MIL	BLUE CRYSTAL	<input type="checkbox"/> 20 MIL <input type="checkbox"/> 28 MIL
SCOTTSDALE	<input type="checkbox"/> 20 MIL <input type="checkbox"/> 28 MIL	BLUE OPAL	<input type="checkbox"/> 28 MIL
SEDONA	<input type="checkbox"/> 20 MIL <input type="checkbox"/> 28 MIL	INDIGO ARCTIC HD	<input type="checkbox"/> 20 MIL
SIGNATURE SERIES		COBBLESTONE	<input type="checkbox"/> 20 MIL <input type="checkbox"/> 28 MIL
CARNEGIE INDIGO	<input type="checkbox"/> 28/20 MIL	CRYSTAL QUARTZ	<input type="checkbox"/> 28 MIL
BLUE CABO	<input type="checkbox"/> 28/20 MIL	ECLIPSE AMBER	<input type="checkbox"/> 28 MIL
LOS CABOS	<input type="checkbox"/> 28/20 MIL	GRAY BONAIR	<input type="checkbox"/> 28 MIL
MADISON	<input type="checkbox"/> 28/20 MIL	GRAY CRYSTAL	<input type="checkbox"/> 28 MIL
SOUTH BEACH	<input type="checkbox"/> 28/20 MIL	GRAY OPAL	<input type="checkbox"/> 28 MIL
SHIMMER STONE FOR DESTINATION SERIES		GUNITE LIGHT BLUE	<input type="checkbox"/> 20 MIL <input type="checkbox"/> 28 MIL
ESAGONO	<input type="checkbox"/> 28 MIL	MOSAIC DARK GRAY	<input type="checkbox"/> 28 MIL
IVY INDIGO	<input type="checkbox"/> 20 MIL <input type="checkbox"/> 28 MIL	MOSAIC LIGHT BLUE	<input type="checkbox"/> 20 MIL <input type="checkbox"/> 28 MIL
PEARLSTONE	<input type="checkbox"/> 28 MIL	MYSTIC LIGHT BLUE	<input type="checkbox"/> 28 MIL
OBSIDIAN	<input type="checkbox"/> 28 MIL	POLYNESIAN	<input type="checkbox"/> 28 MIL
BLUE SLATE	<input type="checkbox"/> 28 MIL	ROYAL AMBER	<input type="checkbox"/> 28 MIL
FLOORTEX SERIES		SAND GUNITE	<input type="checkbox"/> 20 MIL <input type="checkbox"/> 28 MIL
MOUNT GRIS	<input type="checkbox"/> 28 MIL	SANDSTONE TAN	<input type="checkbox"/> 20 MIL <input type="checkbox"/> 28 MIL
MOUNT BLEU	<input type="checkbox"/> 28 MIL	SLATE	<input type="checkbox"/> 28 MIL
		TERRAZO CARIBBEAN	<input type="checkbox"/> 20 MIL <input type="checkbox"/> 28 MIL
		TERRAZO ICE	<input type="checkbox"/> 20 MIL <input type="checkbox"/> 28 MIL
		WHITE PACIFIC	<input type="checkbox"/> 28 MIL

ALTERNATE MATERIAL SELECTION #2

I AUTHORIZE GLI TO ENTER THE ALTERNATE MATERIAL SELECTIONS WHEN THE PRIMARY SELECTION IS NOT AVAILABLE.

_____ CHECK BOX & INIT.

CUSTOMER TAG NAME:		ORDER INFORMATION	
		QUOTE #:	SO#:
			PO#:
STANDARD LINER PATTERN SELECTION		STANDARD LINER PATTERN SELECTION	
STANDARD PATTERN	MIL SELECTION	STANDARD PATTERN	MIL SELECTION
DESTINATION SERIES		SIGNATURE PLUS SERIES	
BARI	<input type="checkbox"/> 28 MIL	WHITEHAVEN	<input type="checkbox"/> 28/28 MIL
BISCAY	<input type="checkbox"/> 28 MIL	MODESTO	<input type="checkbox"/> 28/28 MIL
BLUE HAMPTON	<input type="checkbox"/> 20 MIL <input type="checkbox"/> 28 MIL	OCEAN BEACH	<input type="checkbox"/> 28/28 MIL
BLUE RALEIGH	<input type="checkbox"/> 20 MIL <input type="checkbox"/> 28 MIL	ST. GEORGE	<input type="checkbox"/> 28/28 MIL
BREAKING SEAWALL	<input type="checkbox"/> 28 MIL	ST. BARTS	<input type="checkbox"/> 28/28 MIL
DURANGO	<input type="checkbox"/> 28 MIL	LAGUNA	<input type="checkbox"/> 28/28 MIL
FALLING ESAGONO	<input type="checkbox"/> 28 MIL	CAYMAN	<input type="checkbox"/> 28/28 MIL
FLAGSTONE GRAY	<input type="checkbox"/> 28 MIL	MARCO ISLAND	<input type="checkbox"/> 28/28 MIL
FLAGSTONE TAN	<input type="checkbox"/> 28 MIL	SANTA BARBARA	<input type="checkbox"/> 28/28 MIL
GALLIO	<input type="checkbox"/> 28 MIL	MALIBU	<input type="checkbox"/> 28/28 MIL
ISLAND WAVE	<input type="checkbox"/> 20 MIL <input type="checkbox"/> 28 MIL	FULL FLOOR (FF) PATTERN SELECTION	
LEON	<input type="checkbox"/> 28 MIL	NO TILE BORDER PATTERNS ONLY!	
MESA	<input type="checkbox"/> 20 MIL <input type="checkbox"/> 28 MIL	FF PATTERN	MIL
MIDNIGHT OCEAN	<input type="checkbox"/> 20 MIL <input type="checkbox"/> 28 MIL	AQUARIUS	<input type="checkbox"/> 20 MIL <input type="checkbox"/> 28 MIL
MONTERREY	<input type="checkbox"/> 20 MIL <input type="checkbox"/> 28 MIL	AQUARIUS HD	<input type="checkbox"/> 28 MIL
MOUNTAIN MOSAIC	<input type="checkbox"/> 20 MIL <input type="checkbox"/> 28 MIL	AURORA	<input type="checkbox"/> 20 MIL
NERO	<input type="checkbox"/> 28 MIL	BEACH PEBBLE BLUE	<input type="checkbox"/> 20 MIL <input type="checkbox"/> 28 MIL
OXFORD	<input type="checkbox"/> 28 MIL	BLUE BONAIR	<input type="checkbox"/> 28 MIL
SAVANNAH	<input type="checkbox"/> 20 MIL <input type="checkbox"/> 28 MIL	BLUE CRYSTAL	<input type="checkbox"/> 20 MIL <input type="checkbox"/> 28 MIL
SCOTTSDALE	<input type="checkbox"/> 20 MIL <input type="checkbox"/> 28 MIL	BLUE OPAL	<input type="checkbox"/> 28 MIL
SEDONA	<input type="checkbox"/> 20 MIL <input type="checkbox"/> 28 MIL	INDIGO ARCTIC HD	<input type="checkbox"/> 20 MIL
SIGNATURE SERIES		COBBLESTONE	<input type="checkbox"/> 20 MIL <input type="checkbox"/> 28 MIL
CARNEGIE INDIGO	<input type="checkbox"/> 28/20 MIL	CRYSTAL QUARTZ	<input type="checkbox"/> 28 MIL
BLUE CABO	<input type="checkbox"/> 28/20 MIL	ECLIPSE AMBER	<input type="checkbox"/> 28 MIL
LOS CABOS	<input type="checkbox"/> 28/20 MIL	GRAY BONAIR	<input type="checkbox"/> 28 MIL
MADISON	<input type="checkbox"/> 28/20 MIL	GRAY CRYSTAL	<input type="checkbox"/> 28 MIL
SOUTH BEACH	<input type="checkbox"/> 28/20 MIL	GRAY OPAL	<input type="checkbox"/> 28 MIL
SHIMMER STONE FOR DESTINATION SERIES		GUNITE LIGHT BLUE	<input type="checkbox"/> 20 MIL <input type="checkbox"/> 28 MIL
ESAGONO	<input type="checkbox"/> 28 MIL	MOSAIC DARK GRAY	<input type="checkbox"/> 28 MIL
IVY INDIGO	<input type="checkbox"/> 20 MIL <input type="checkbox"/> 28 MIL	MOSAIC LIGHT BLUE	<input type="checkbox"/> 20 MIL <input type="checkbox"/> 28 MIL
PEARLSTONE	<input type="checkbox"/> 28 MIL	MYSTIC LIGHT BLUE	<input type="checkbox"/> 28 MIL
OBSIDIAN	<input type="checkbox"/> 28 MIL	POLYNESIAN	<input type="checkbox"/> 28 MIL
BLUE SLATE	<input type="checkbox"/> 28 MIL	ROYAL AMBER	<input type="checkbox"/> 28 MIL
FLOORTEX SERIES		SAND GUNITE	<input type="checkbox"/> 20 MIL <input type="checkbox"/> 28 MIL
MOUNT GRIS	<input type="checkbox"/> 28 MIL	SANDSTONE TAN	<input type="checkbox"/> 20 MIL <input type="checkbox"/> 28 MIL
MOUNT BLEU	<input type="checkbox"/> 28 MIL	SLATE	<input type="checkbox"/> 28 MIL
		TERRAZO CARIBBEAN	<input type="checkbox"/> 20 MIL <input type="checkbox"/> 28 MIL
		TERRAZO ICE	<input type="checkbox"/> 20 MIL <input type="checkbox"/> 28 MIL
		WHITE PACIFIC	<input type="checkbox"/> 28 MIL

NON-STANDARD PATTERN SELECTION

CUSTOMER TAG NAME:	ORDER INFORMATION		
	QUOTE #:	SO#:	PO#:

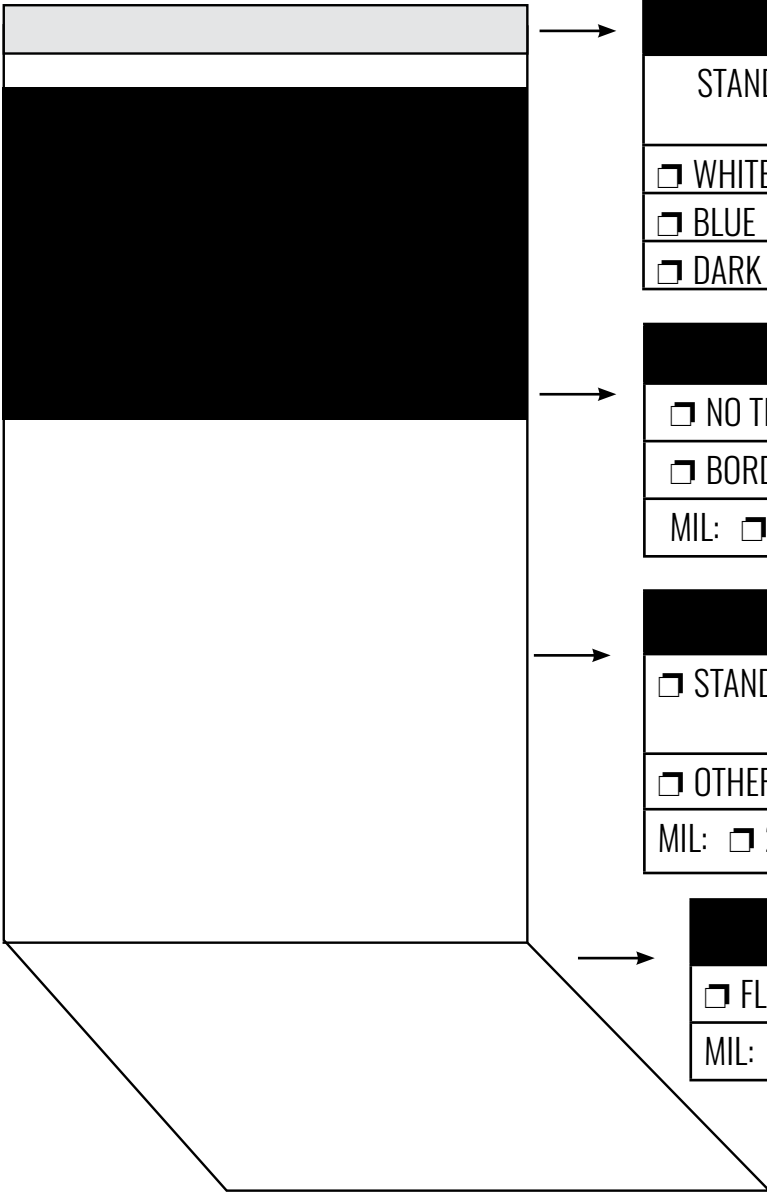
	BEAD TYPE / COLOR																
	<table border="1" style="width: 100%;"> <tr> <td colspan="2">STANDARD BEAD:</td> <td>UNI BEAD:</td> <td>ESTHER WILLIAMS BEAD (WHITE): <input type="checkbox"/></td> </tr> <tr> <td><input type="checkbox"/> WHITE</td> <td><input type="checkbox"/> BLACK</td> <td><input type="checkbox"/> WHITE</td> <td>WILKES BEAD (WHITE): <input type="checkbox"/></td> </tr> <tr> <td><input type="checkbox"/> BLUE</td> <td><input type="checkbox"/> TAN</td> <td><input type="checkbox"/> BLUE</td> <td>OVERLAP/NO BEAD: <input type="checkbox"/></td> </tr> <tr> <td colspan="2"><input type="checkbox"/> DARK GRAY</td> <td></td> <td></td> </tr> </table>	STANDARD BEAD:		UNI BEAD:	ESTHER WILLIAMS BEAD (WHITE): <input type="checkbox"/>	<input type="checkbox"/> WHITE	<input type="checkbox"/> BLACK	<input type="checkbox"/> WHITE	WILKES BEAD (WHITE): <input type="checkbox"/>	<input type="checkbox"/> BLUE	<input type="checkbox"/> TAN	<input type="checkbox"/> BLUE	OVERLAP/NO BEAD: <input type="checkbox"/>	<input type="checkbox"/> DARK GRAY			
	STANDARD BEAD:		UNI BEAD:	ESTHER WILLIAMS BEAD (WHITE): <input type="checkbox"/>													
	<input type="checkbox"/> WHITE	<input type="checkbox"/> BLACK	<input type="checkbox"/> WHITE	WILKES BEAD (WHITE): <input type="checkbox"/>													
	<input type="checkbox"/> BLUE	<input type="checkbox"/> TAN	<input type="checkbox"/> BLUE	OVERLAP/NO BEAD: <input type="checkbox"/>													
<input type="checkbox"/> DARK GRAY																	
TILE BORDER																	
<input type="checkbox"/> NO TILE BORDER <input type="checkbox"/> BORDER FROM PATTERN: MIL: <input type="checkbox"/> 20 MIL <input type="checkbox"/> 28 MIL																	
WALL PRINT																	
<input type="checkbox"/> STANDARD WALL <input type="checkbox"/> SAME AS FLOOR (SELECTED BELOW) <input type="checkbox"/> OTHER: MIL: <input type="checkbox"/> 20 MIL <input type="checkbox"/> 28 MIL																	
FLOOR PRINT																	
<input type="checkbox"/> FLOOR PRINT PATTERN: MIL: <input type="checkbox"/> 20 MIL <input type="checkbox"/> 28 MIL																	
STEP PRINT																	
VINYL COVERED STEP: <input type="checkbox"/> YES <input type="checkbox"/> NO SURE-STEP TEXTURED MATERIAL: <input type="checkbox"/> STEP PRINT: MIL: <input type="checkbox"/> 20 MIL <input type="checkbox"/> 28 MIL																	

PLEASE NOTE: ADDITIONAL CHARGES WILL APPLY FOR EACH VARIATION SELECTED.
 IF A PATTERN SELECTION WAS MADE ON PAGE 2 OR 3, SKIP THIS PAGE.
 THIS IS NON-STANDARD PATTERN SELECTION ONLY.

RECTANGLE STANDARD HOPPER

CUSTOMER TAG NAME:

ORDER INFORMATION

QUOTE #: _____ SQ#: _____

PO#:

FIBERGLASS STEPS

YES --> STRAIGHT RADIUS _____
 LOCATION CENTER SHALLOW END OTHER (DRAW IN LOCATION)

VINYL COVERED STEPS

YES --> NOTE: STEP MEASURING FORM REQUIRED
 LOCATION: CENTER SHALLOW END OTHER (DRAW IN LOCATION)

DEPTH MEASUREMENTS

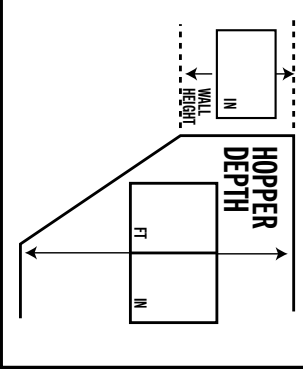

HOPPER PAD CORNERS

SQUARE
 RADIUS _____ IN.

CORNER SIZE & SHAPE

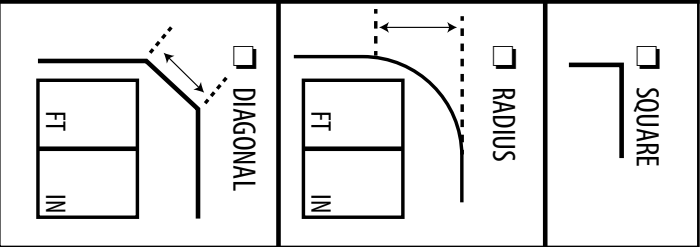

ALL LENGTH MEASUREMENTS MUST ADD UP TO THIS NUMBER.

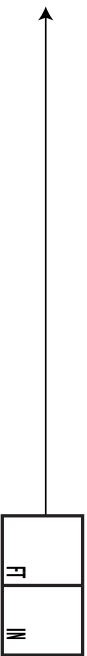

ALL WIDTH MEASUREMENTS MUST ADD UP TO THIS NUMBER.

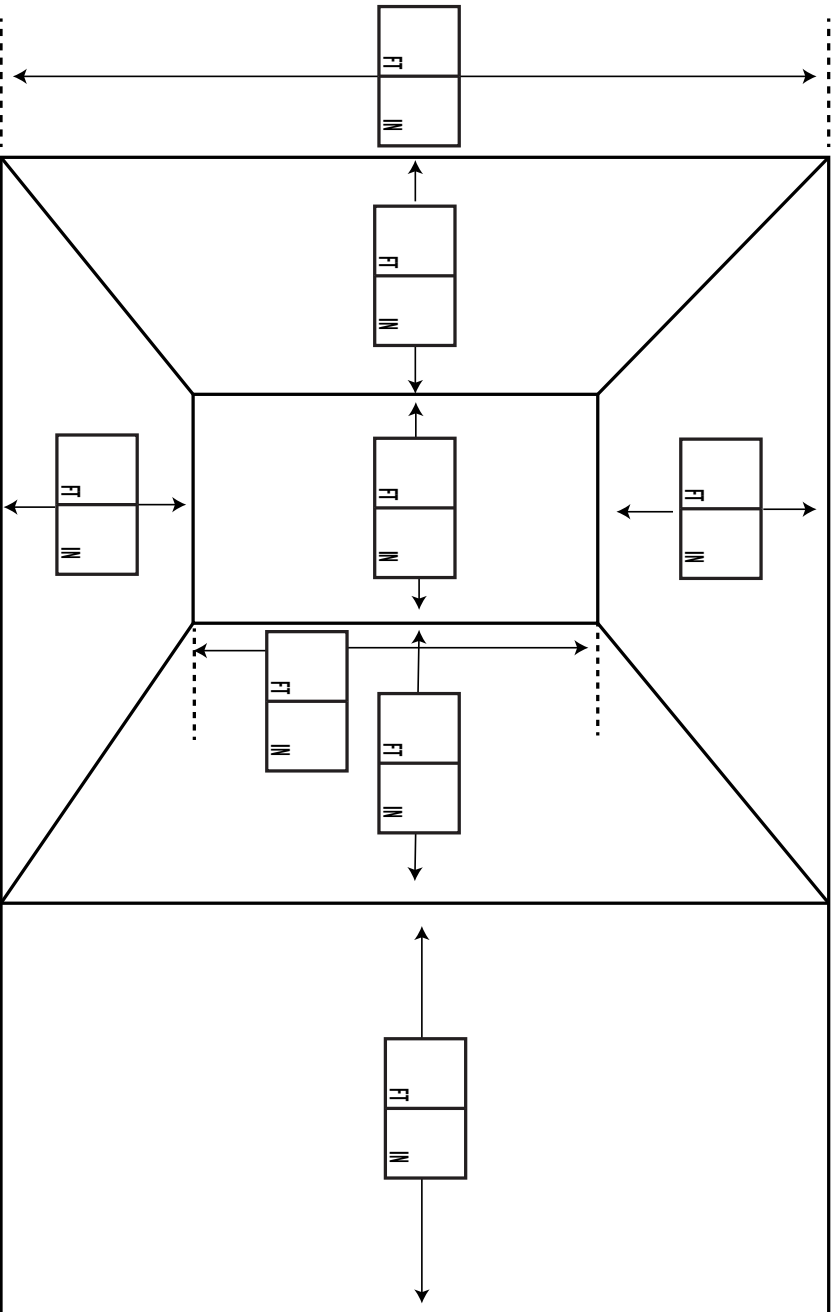



RECTANGLE WITH SAFETY LEDGE

CUSTOMER TAG NAME: _____

ORDER INFORMATION

QUOTE #: _____ SO#: _____

PO#: _____

FIBERGLASS STEPS

YES

STRAIGHT RADIUS

LOCATION: CENTER SHALLOW END OTHER (DRAW IN LOCATION)

VINYL COVERED STEPS

YES --> NOTE: STEP MEASURING FORM REQUIRED

LOCATION: CENTER SHALLOW END OTHER (DRAW IN LOCATION)

DEPTH MEASUREMENTS

WALL HEIGHT _____ IN

HOPPER PAD CORNERS

SQUARE

RADIUS _____ IN

CORNER SIZE & SHAPE

SQUARE

RADIUS

DIAGONAL

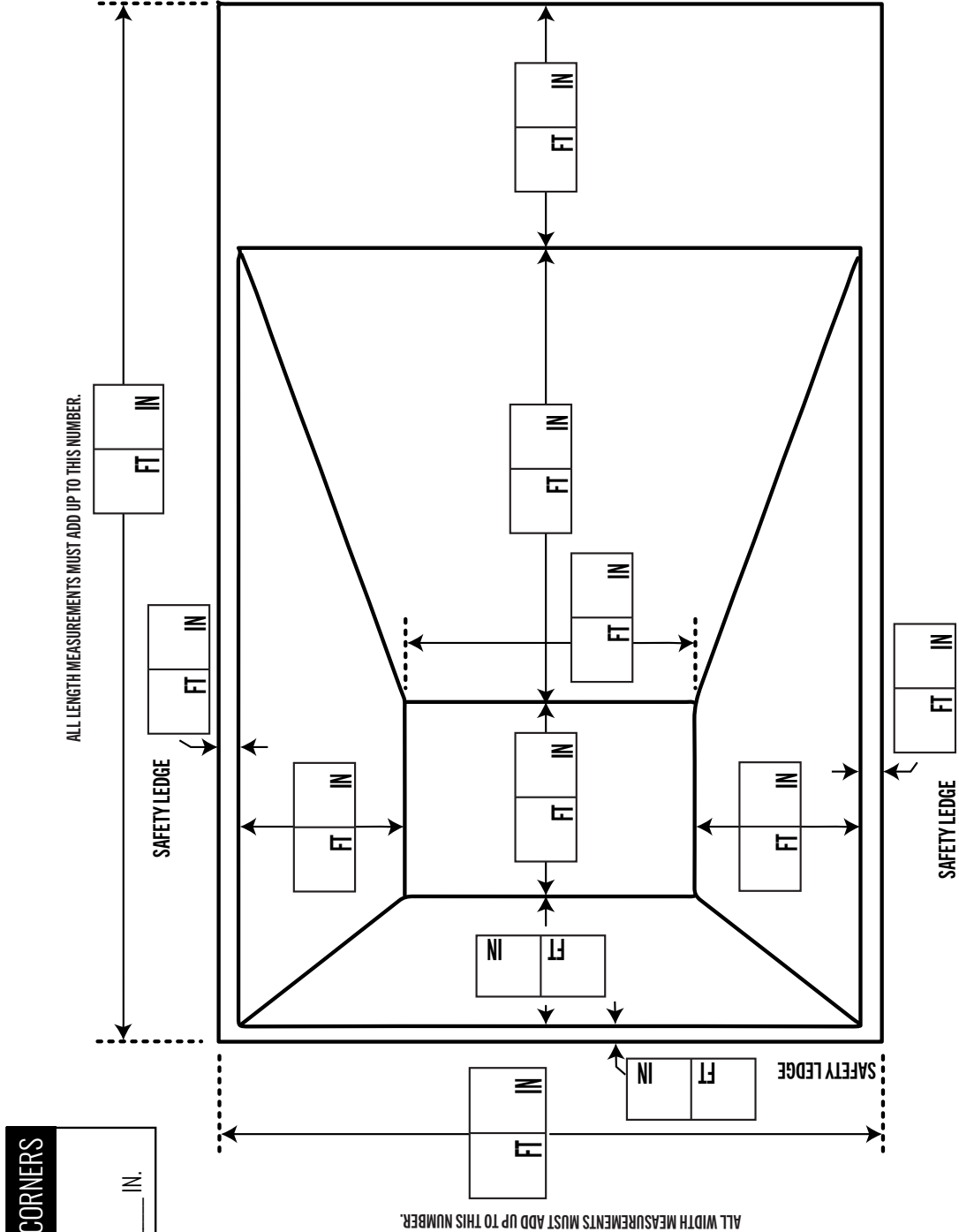

CUSTOMER TAG NAME:

FIBERGLASS STEPS

VINYL COVERED STEPS

ORDER INFORMATION

YES --> STRAIGHT RADIUS
 LOCATION DRAW IN LOCATION

YES --> NOTE: STEP MEASURING FORM REQUIRED
 LOCATION: DRAW IN LOCATION

QUOTE #: _____ SQ#: _____

PO#: _____

DEPTH MEASUREMENTS

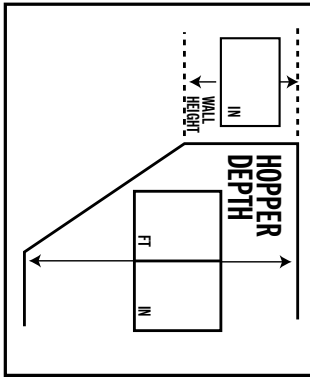

CORNER SIZE & SHAPE

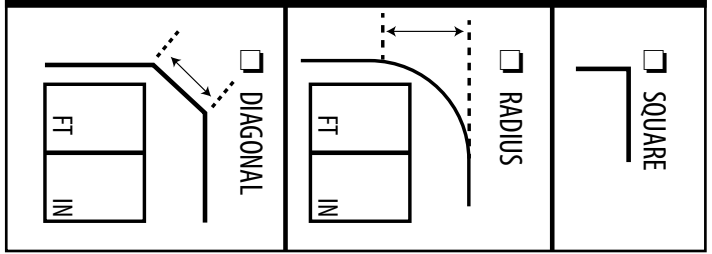

ALL WIDTH MEASUREMENTS MUST ADD UP TO THIS NUMBER.

ALL LENGTH MEASUREMENTS MUST ADD UP TO THIS NUMBER.

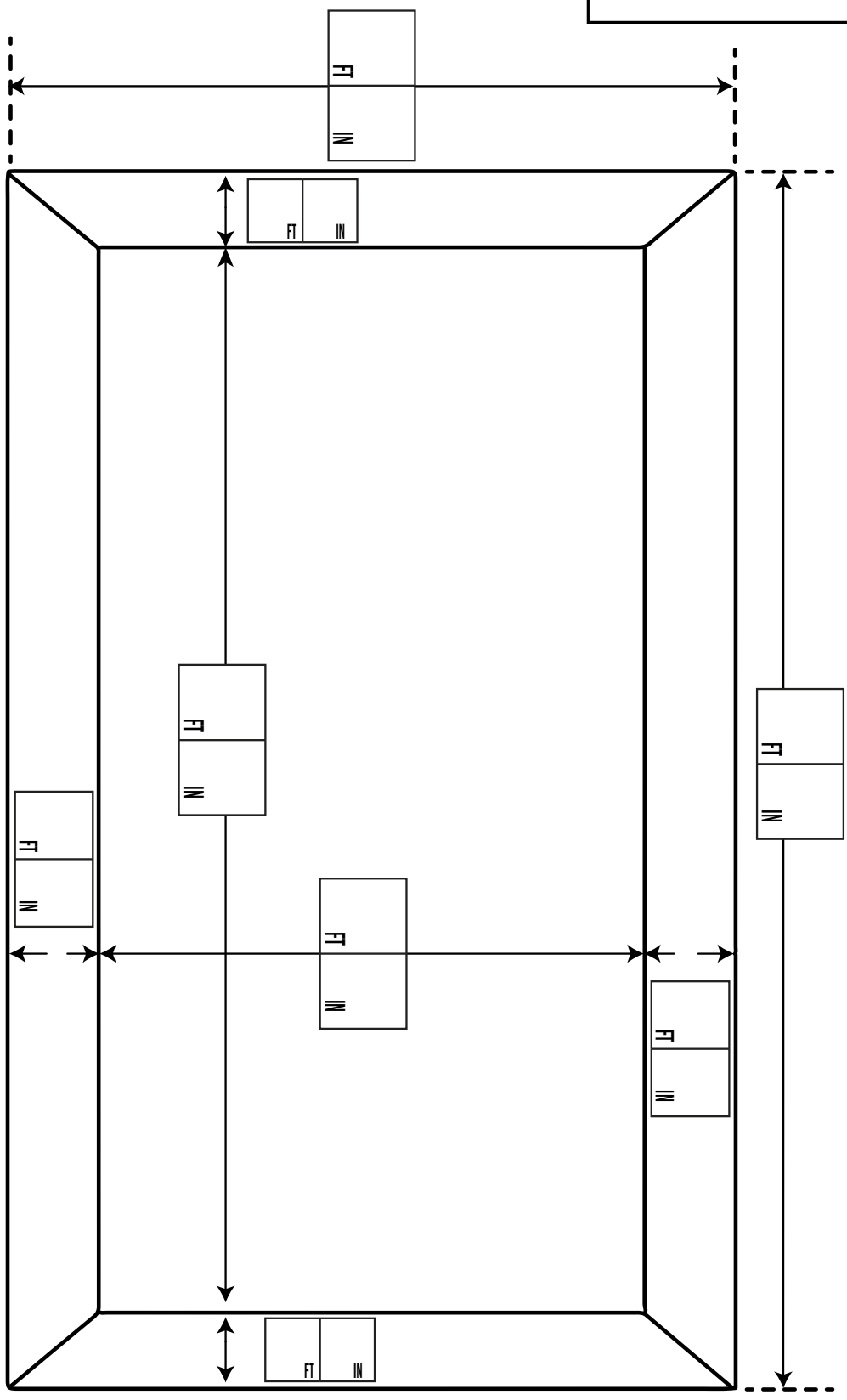



RECTANGLE SPORT

CUSTOMER TAG NAME:

ORDER INFORMATION

QUOTE #:

SO#:

SO#

FIBERGLASS STEPS

- YES --> STRAIGHT RADIUS
- LOCATION DRAW IN LOCATION

VINYL COVERED STEPS

- YES --> NOTE: STEP MEASURING FORM REQUIRED
- LOCATION DRAW IN LOCATION

DEPTH MEASUREMENTS - SIDE VIEW

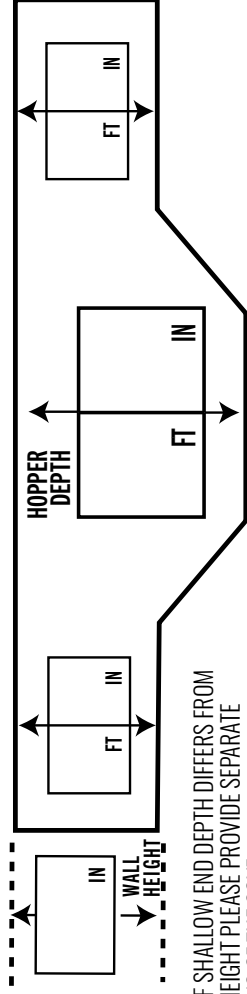

ALL LENGTH MEASUREMENTS MUST ADD UP TO THIS NUMBER.

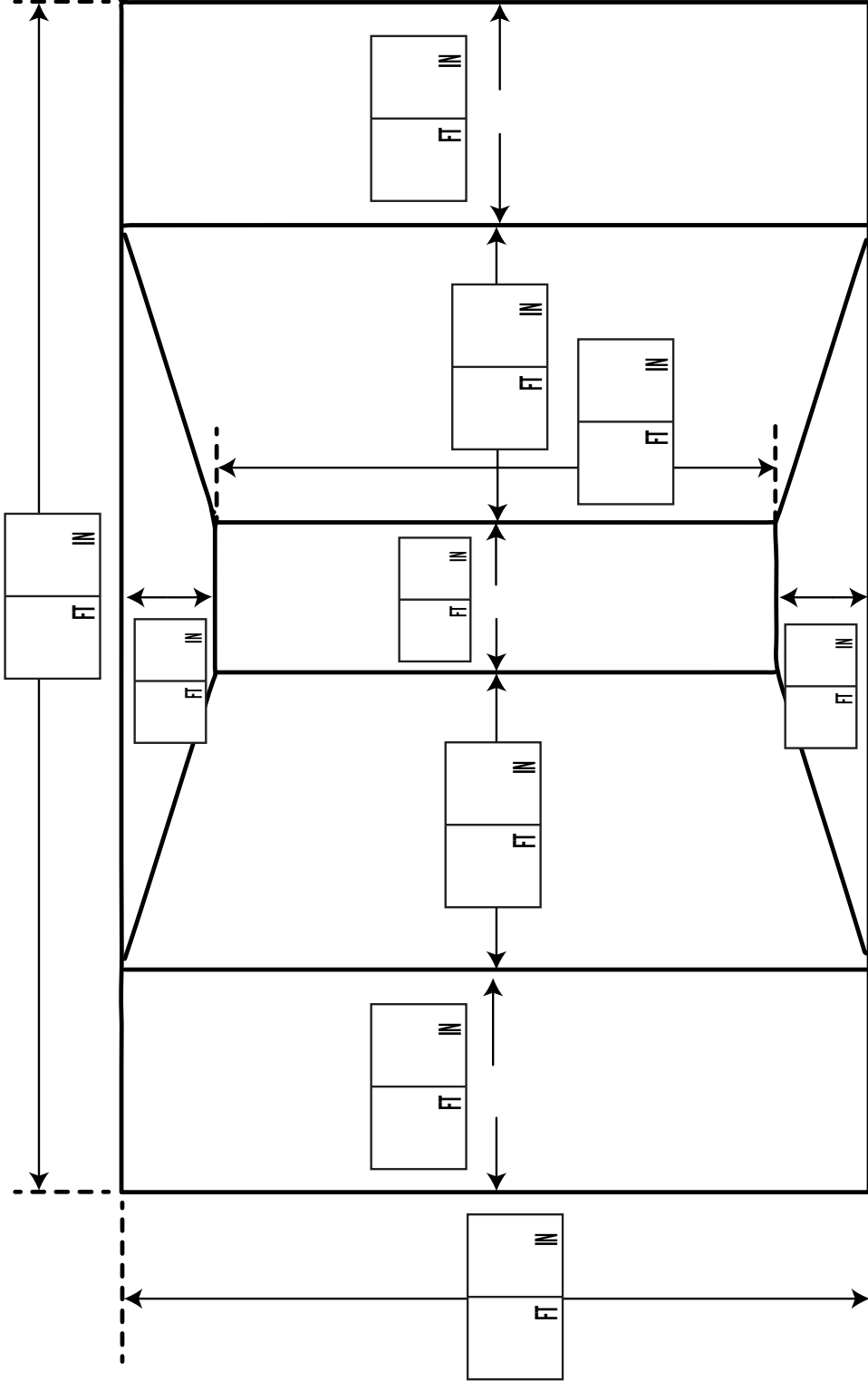

ALL WIDTH MEASUREMENTS MUST ADD UP TO THIS NUMBER.

SQUARE

RADIUS

DIAGONAL

CORNER SIZE & SHAPE

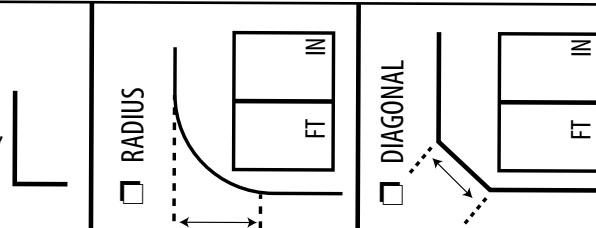

GREGIAN WITH RECTANGLE HOPPER

CUSTOMER TAG NAME:

ORDER INFORMATION

QUOTE #: _____ SQ#: _____

PO#: _____

FIBERGLASS STEPS

YES --> STRAIGHT RADIUS _____
 LOCATION CENTER SHALLOW END OTHER (DRAW IN LOCATION)

VINYL COVERED STEPS

YES --> NOTE: STEP MEASURING FORM REQUIRED
 LOCATION: CENTER SHALLOW END OTHER (DRAW IN LOCATION)

DEPTH MEASUREMENTS

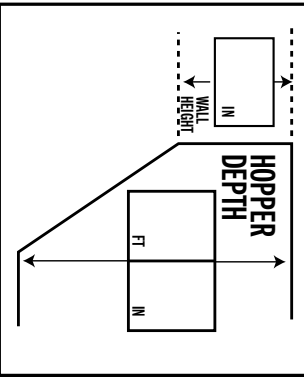

HOPPER PAD CORNERS

SQUARE
 RADIUS _____ IN.

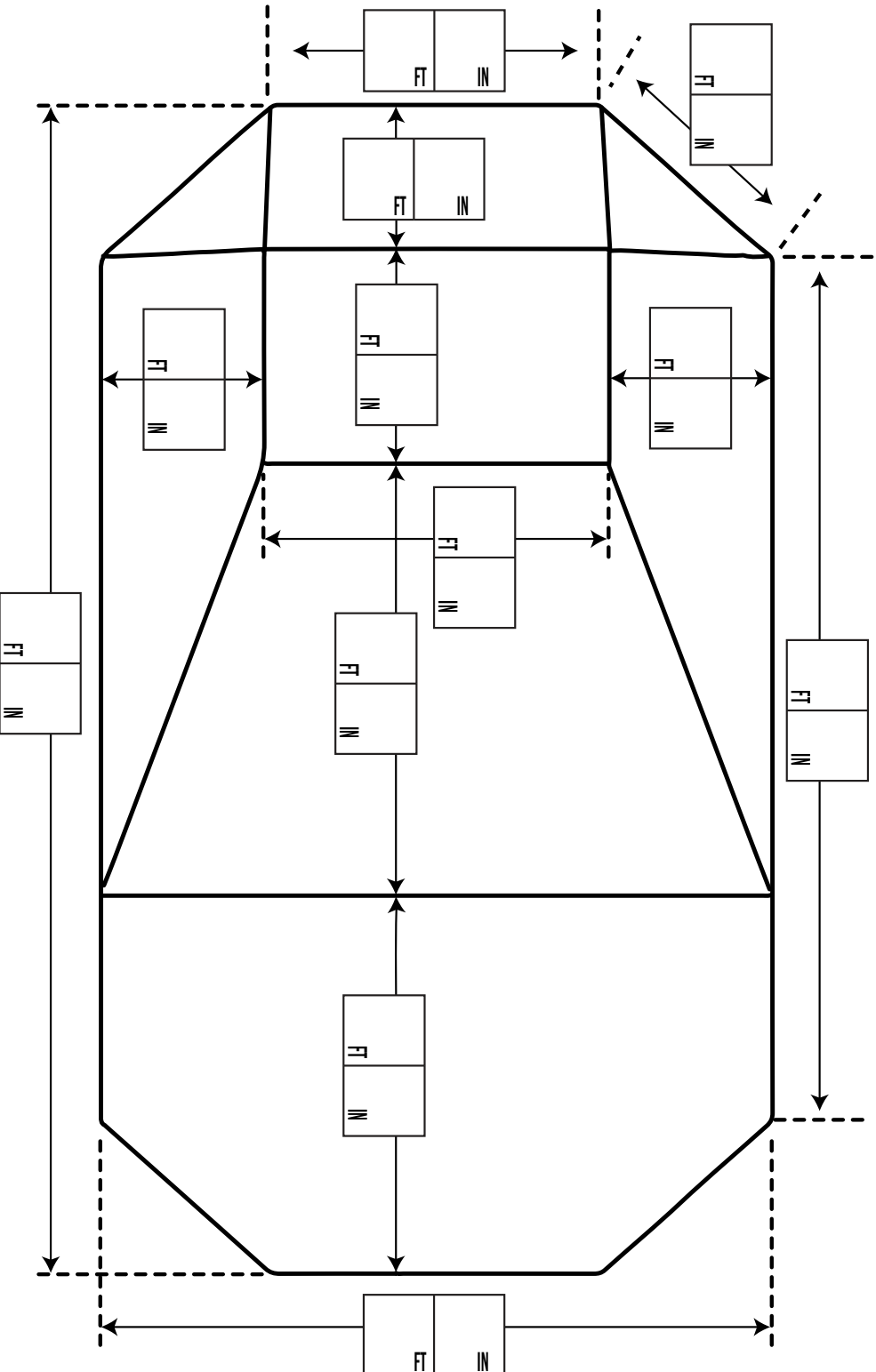

ALL WIDTH MEASUREMENTS MUST ADD UP TO THIS NUMBER.

ALL LENGTH MEASUREMENTS MUST ADD UP TO THIS NUMBER.



GREGIAN WITH GREGIAN HOPPER

CUSTOMER TAG NAME:

ORDER INFORMATION

QUOTE #: _____ SO#: _____

PO#: _____

FIBERGLASS STEPS

YES

STRAIGHT RADIUS

LOCATION: CENTER SHALLOW END OTHER (DRAW IN LOCATION)

VINYL COVERED STEPS

YES --> NOTE: STEP MEASURING FORM REQUIRED

LOCATION: CENTER SHALLOW END OTHER (DRAW IN LOCATION)

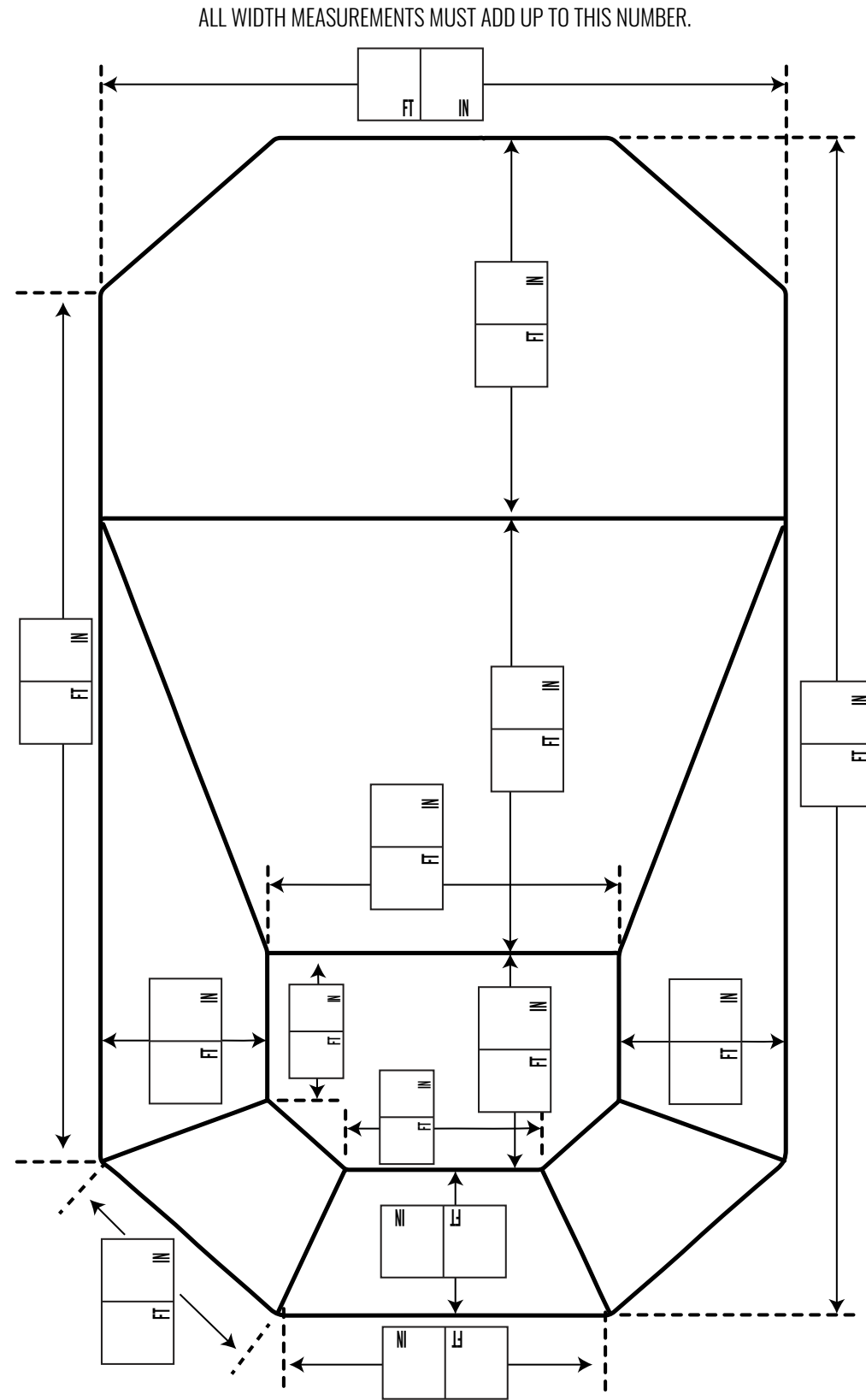
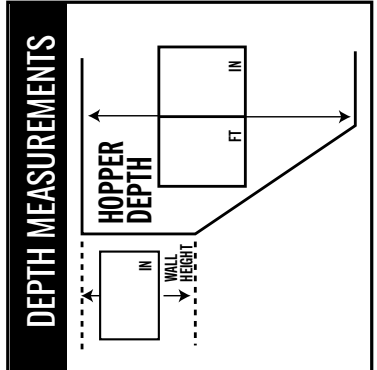

ALL WIDTH MEASUREMENTS MUST ADD UP TO THIS NUMBER.

ALL LENGTH MEASUREMENTS MUST ADD UP TO THIS NUMBER.

JEWEL - JEWEL HOPPER

CUSTOMER TAG NAME:

FIBERGLASS STEPS

VINYL COVERED STEPS

ORDER INFORMATION

- YES --> STRAIGHT RADIUS
 LOCATION CENTER SHALLOW END OTHER (DRAW IN LOCATION)

- YES --> NOTE: STEP MEASURING FORM REQUIRED
 LOCATION: CENTER SHALLOW END OTHER (DRAW IN LOCATION)

QUOTE #: _____ SO#: _____

PO#: _____

DEPTH MEASUREMENTS

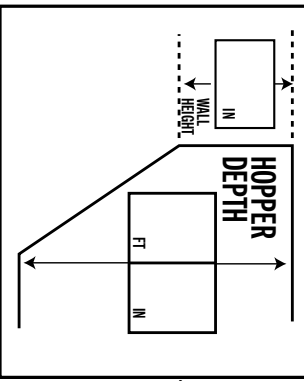

ALL WIDTH MEASUREMENTS MUST ADD UP TO THIS NUMBER.

ALL LENGTH MEASUREMENTS MUST ADD UP TO THIS NUMBER.

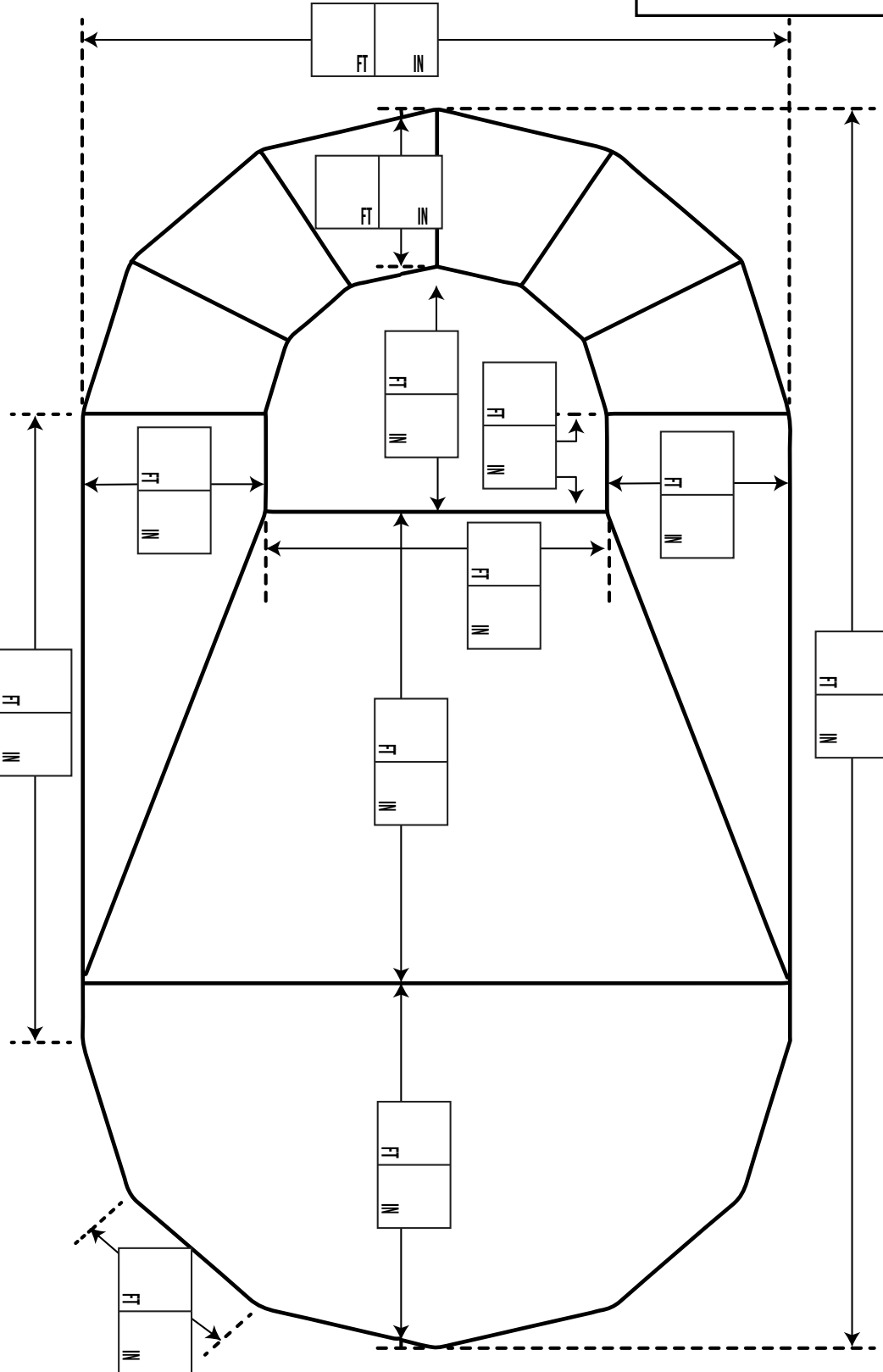



JEWEL - OVAL HOPPER

CUSTOMER TAG NAME: _____

ORDER INFORMATION

QUOTE #: _____ SO#: _____

PO#: _____

FIBERGLASS STEPS

YES

STRAIGHT RADIUS

LOCATION: CENTER SHALLOW END OTHER (DRAW IN LOCATION)

VINYL COVERED STEPS

YES --> NOTE: STEP MEASURING FORM REQUIRED

LOCATION: CENTER SHALLOW END OTHER (DRAW IN LOCATION)

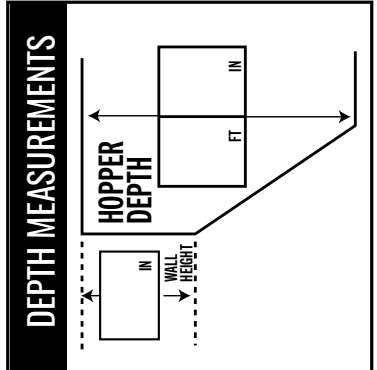

ALL WIDTH MEASUREMENTS MUST ADD UP TO THIS NUMBER.

ALL LENGTH MEASUREMENTS MUST ADD UP TO THIS NUMBER.

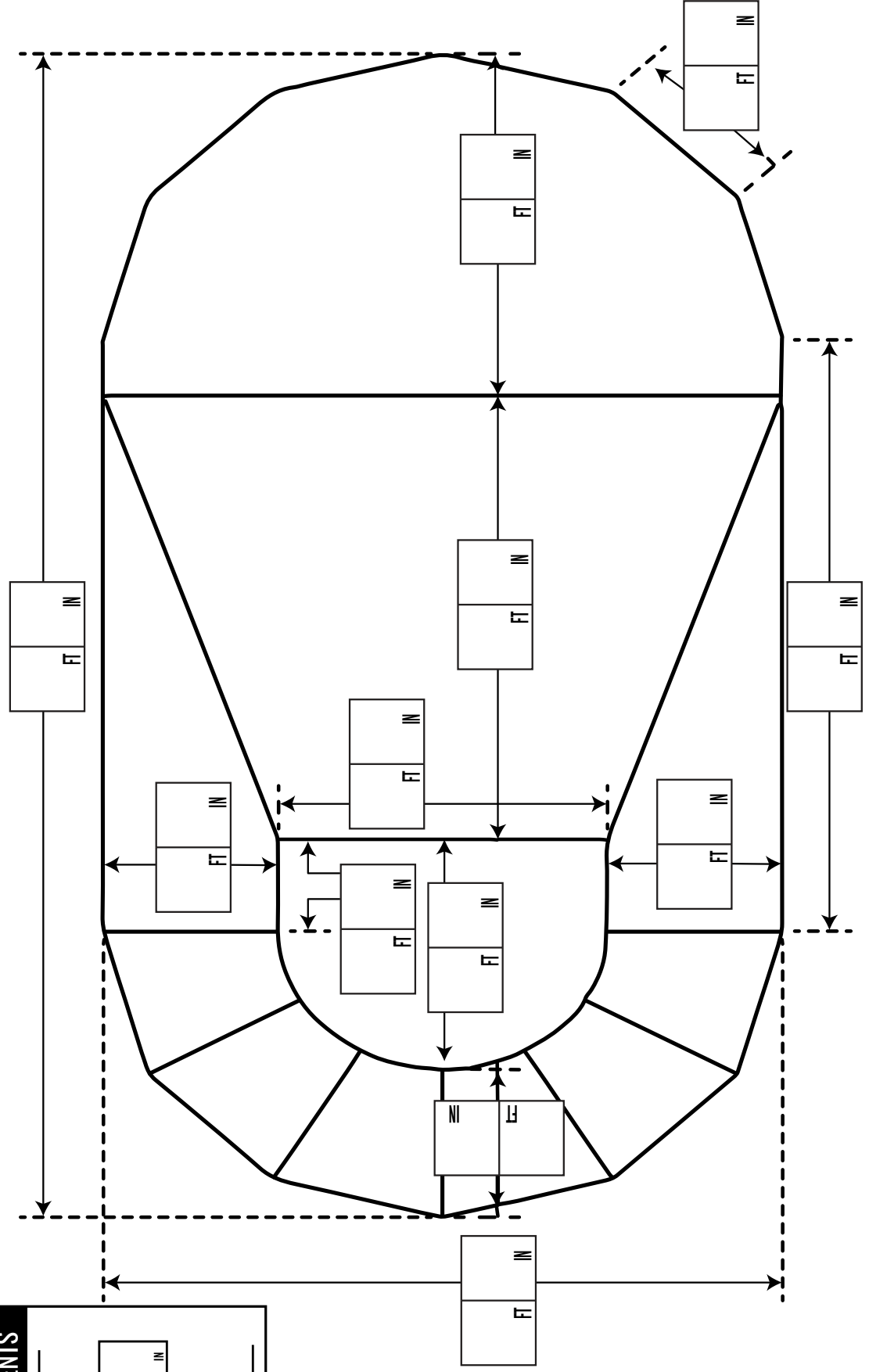

CUSTOMER TAG NAME:

ORDER INFORMATION

QUOTE #: _____ SQ#: _____

PO#:

FIBERGLASS STEPS

YES --> STRAIGHT RADIUS _____
 LOCATION CENTER SHALLOW END OTHER (DRAW IN LOCATION)

VINYL COVERED STEPS

YES --> NOTE: STEP MEASURING FORM REQUIRED
 LOCATION: CENTER SHALLOW END OTHER (DRAW IN LOCATION)

DEPTH MEASUREMENTS

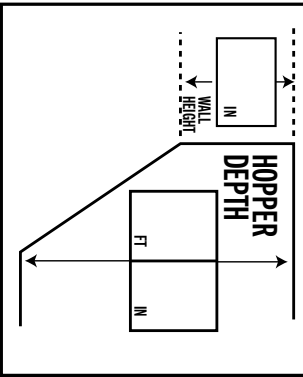

HOPPER PAD CORNERS

SQUARE
 RADIUS _____ IN.

NOTE: DOTTED LINE BOXES ARE FOR DIAGONAL LINE MEASUREMENTS ONLY!

CORNER SIZE & SHAPE

SQUARE

RADIUS

DIAGONAL

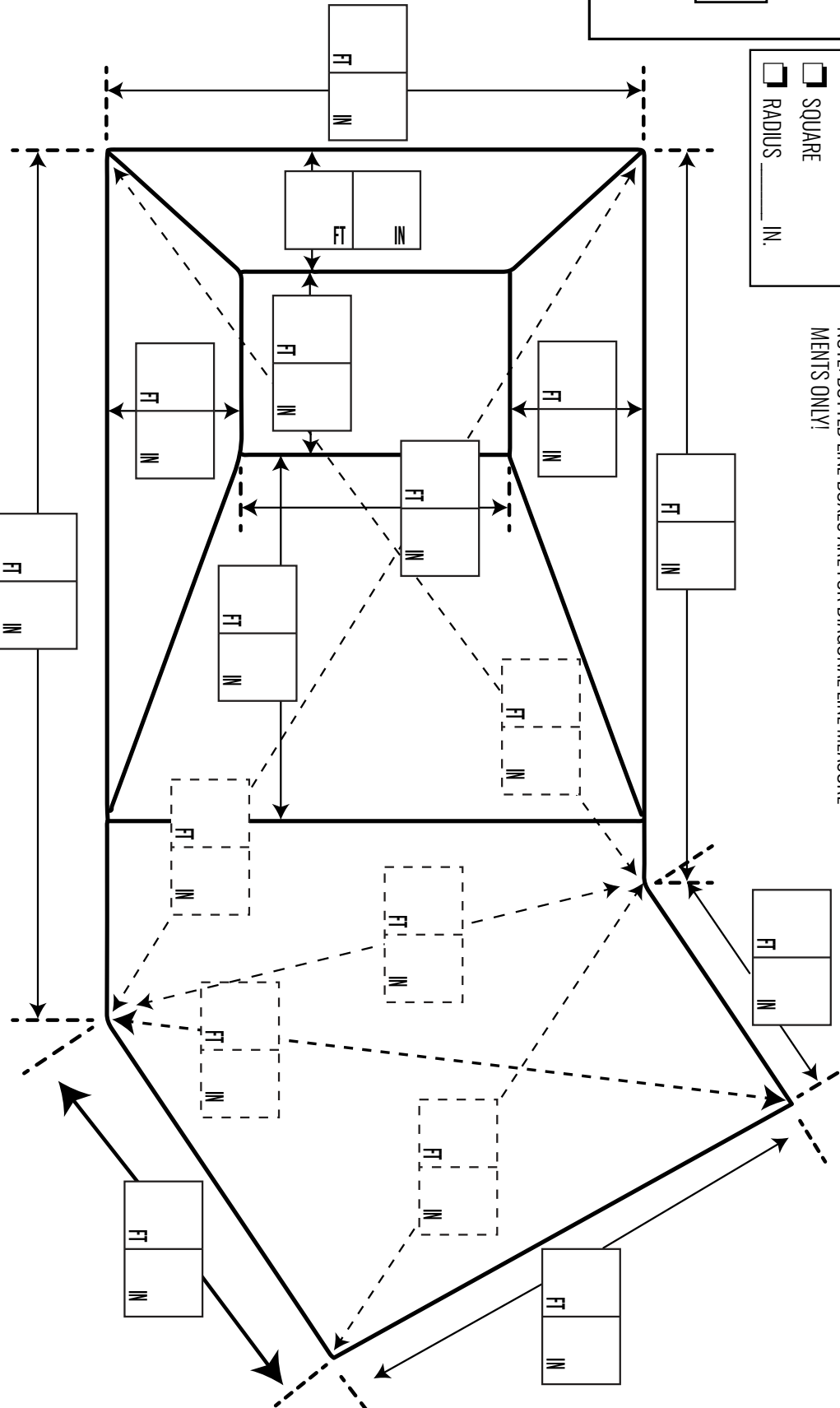



LAZY-L RIGHT - STANDARD HOPPER

CUSTOMER TAG NAME:

ORDER INFORMATION

QUOTE #: _____ SO#: _____

PO#: _____

FIBERGLASS STEPS

YES

STRAIGHT RADIUS

LOCATION: CENTER SHALLOW END OTHER (DRAW IN LOCATION)

VINYL COVERED STEPS

YES --> NOTE: STEP MEASURING FORM REQUIRED

LOCATION: CENTER SHALLOW END OTHER (DRAW IN LOCATION)

DEPTH MEASUREMENTS

WALL HEIGHT: _____ IN.

HOPPER DEPTH: _____ FT. _____ IN.

HOPPER PAD CORNERS

SQUARE

RADIUS _____ IN.

NOTE: DOTTED LINE BOXES ARE FOR DIAGONAL LINE MEASUREMENTS ONLY!

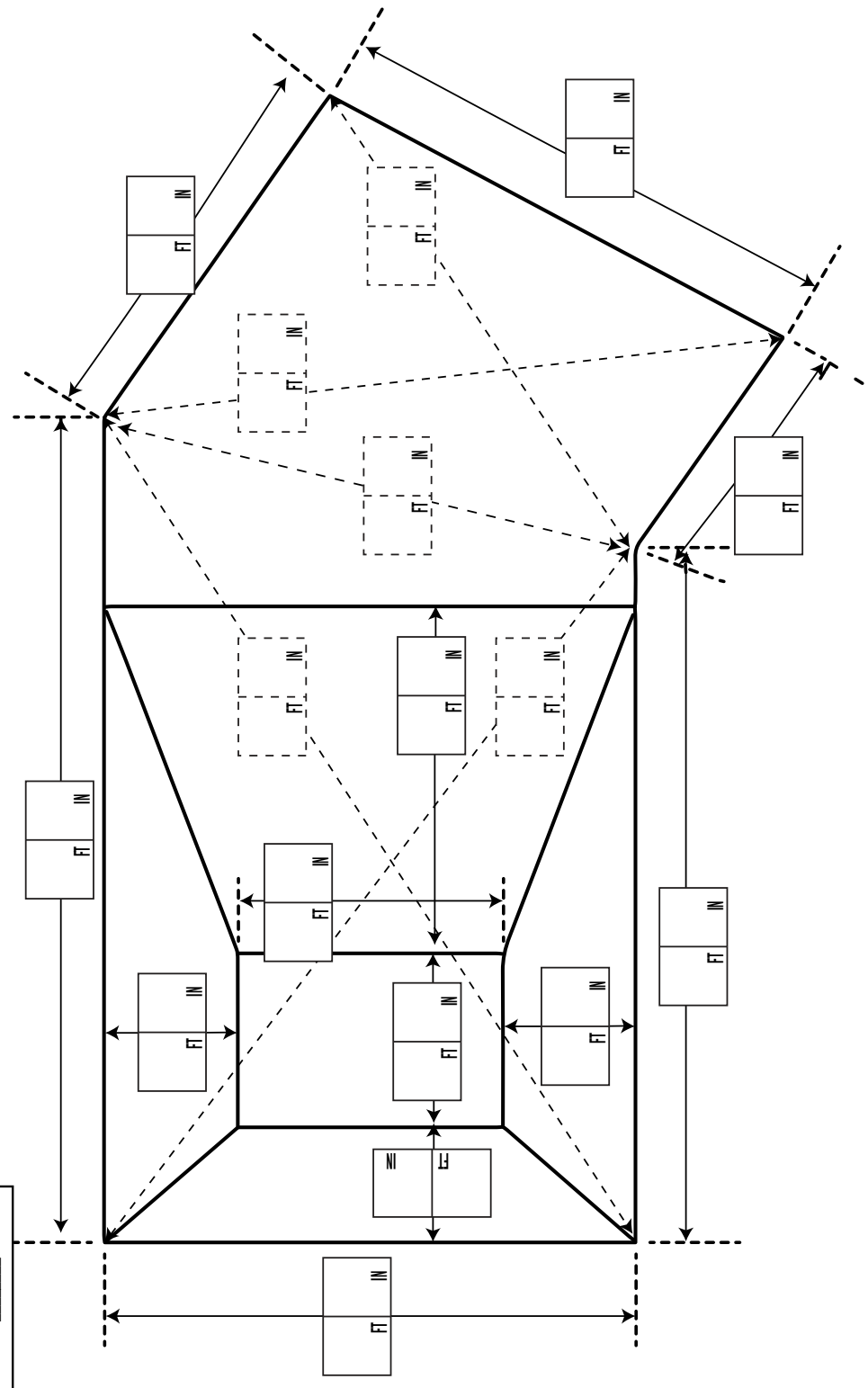

CORNER SIZE & SHAPE

SQUARE

RADIUS

DIAGONAL

TRUE-L LEFT - STANDARD HOPPER

CUSTOMER TAG NAME:

ORDER INFORMATION

QUOTE #: _____ SQ#: _____

PO#:

FIBERGLASS STEPS

YES --> STRAIGHT RADIUS _____
 LOCATION CENTER SHALLOW END OTHER (DRAW IN LOCATION)

VINYL COVERED STEPS

YES --> NOTE: STEP MEASURING FORM REQUIRED
 LOCATION: CENTER SHALLOW END OTHER (DRAW IN LOCATION)

DEPTH MEASUREMENTS

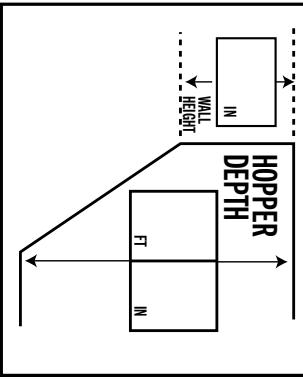

HOPPER PAD CORNERS

SQUARE
 RADIUS _____ IN.

CORNER SIZE & SHAPE

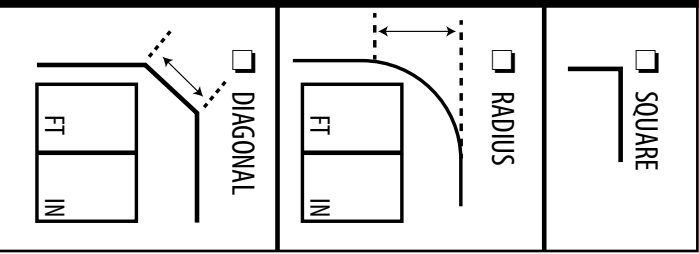

ALL WIDTH MEASUREMENTS MUST ADD UP TO THIS NUMBER.

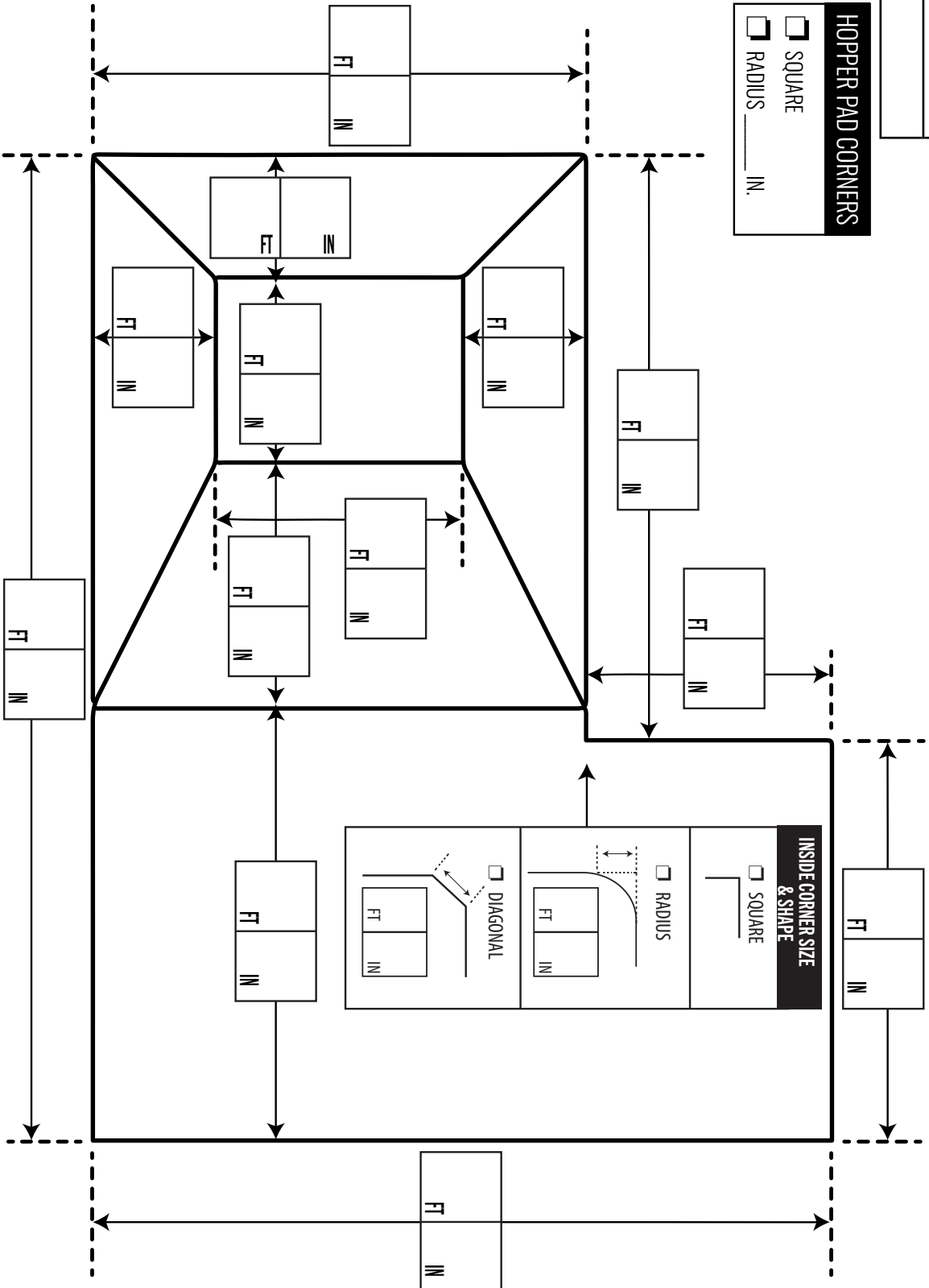

ALL LENGTH MEASUREMENTS MUST ADD UP TO THIS NUMBER.



TRUE-L RIGHT - STANDARD HOPPER

CUSTOMER TAG NAME: _____

ORDER INFORMATION

QUOTE #: _____ SO#: _____

PO#: _____

FIBERGLASS STEPS

YES

STRAIGHT RADIUS

LOCATION: CENTER SHALLOW END OTHER (DRAW IN LOCATION)

VINYL COVERED STEPS

YES --> NOTE: STEP MEASURING FORM REQUIRED

LOCATION: CENTER SHALLOW END OTHER (DRAW IN LOCATION)

DEPTH MEASUREMENTS

HOPPER DEPTH _____ FT IN

WALL HEIGHT _____ IN

HOPPER PAD CORNERS

SQUARE

RADIUS _____ IN.

ALL LENGTH MEASUREMENTS MUST ADD UP TO THIS NUMBER.

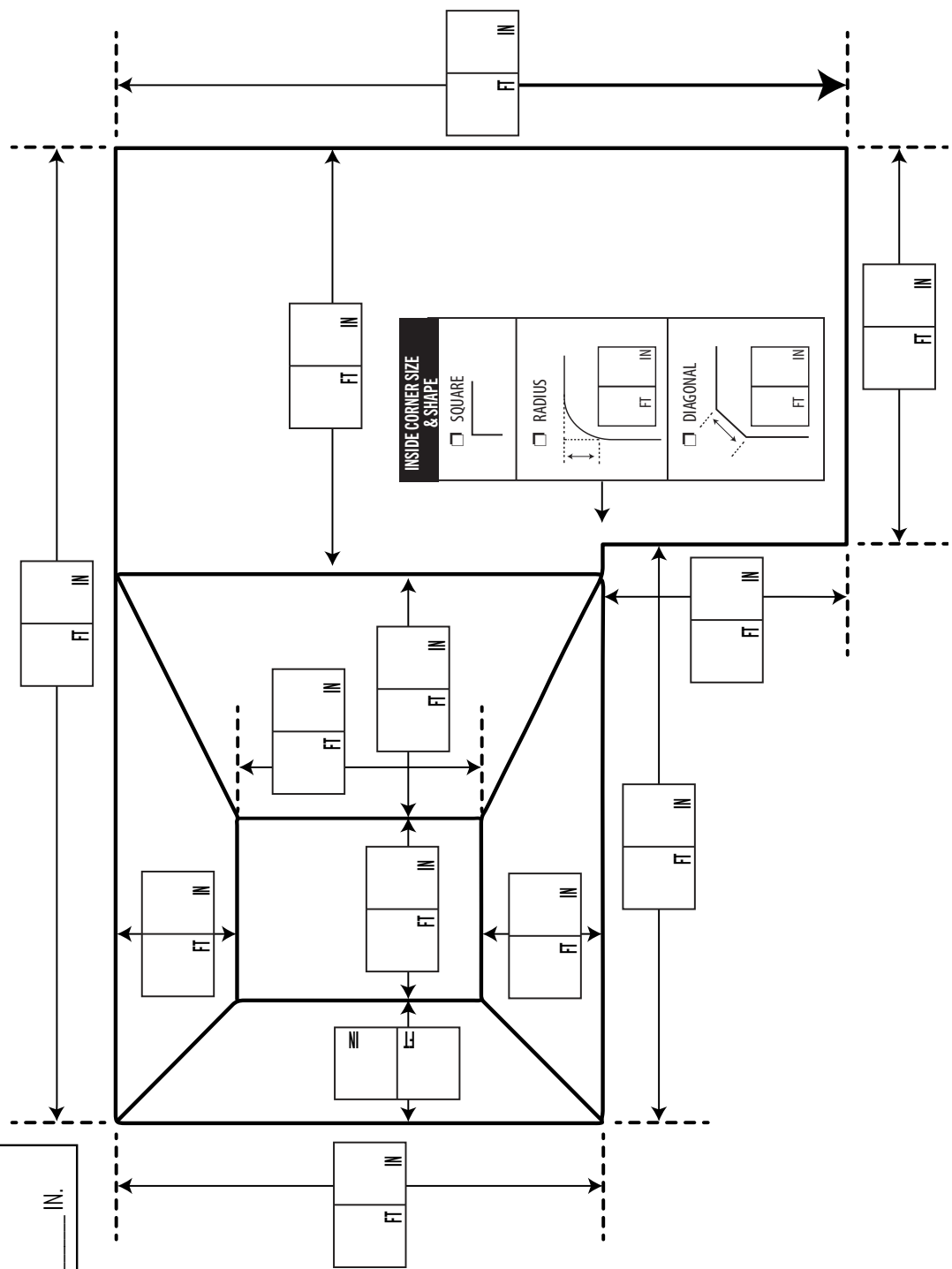

ALL WIDTH MEASUREMENTS MUST ADD UP TO THIS NUMBER.

CORNER SIZE & SHAPE

SQUARE

RADIUS _____ FT IN

DIAGONAL _____ FT IN

INSIDE CORNER SIZE & SHAPE

SQUARE

RADIUS _____ FT IN

DIAGONAL _____ FT IN

OVAL FLAT BOTTOM WITH COVE

CUSTOMER TAG NAME:

ORDER INFORMATION

QUOTE #: _____ SO#: _____

PO#: _____

FIBERGLASS STEPS

- YES --> STRAIGHT RADIUS
- LOCATION CENTER SHALLOW END OTHER (DRAW IN LOCATION)

VINYL COVERED STEPS

- YES --> NOTE: STEP MEASURING FORM REQUIRED
- LOCATION: CENTER SHALLOW END OTHER (DRAW IN LOCATION)

DEPTH MEASUREMENTS

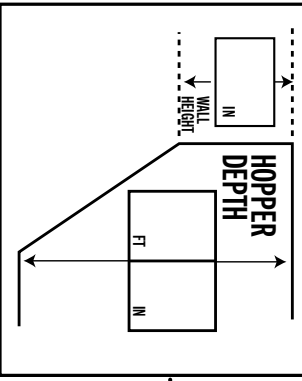

ALL WIDTH MEASUREMENTS MUST ADD UP TO THIS NUMBER.

ALL LENGTH MEASUREMENTS MUST ADD UP TO THIS NUMBER.

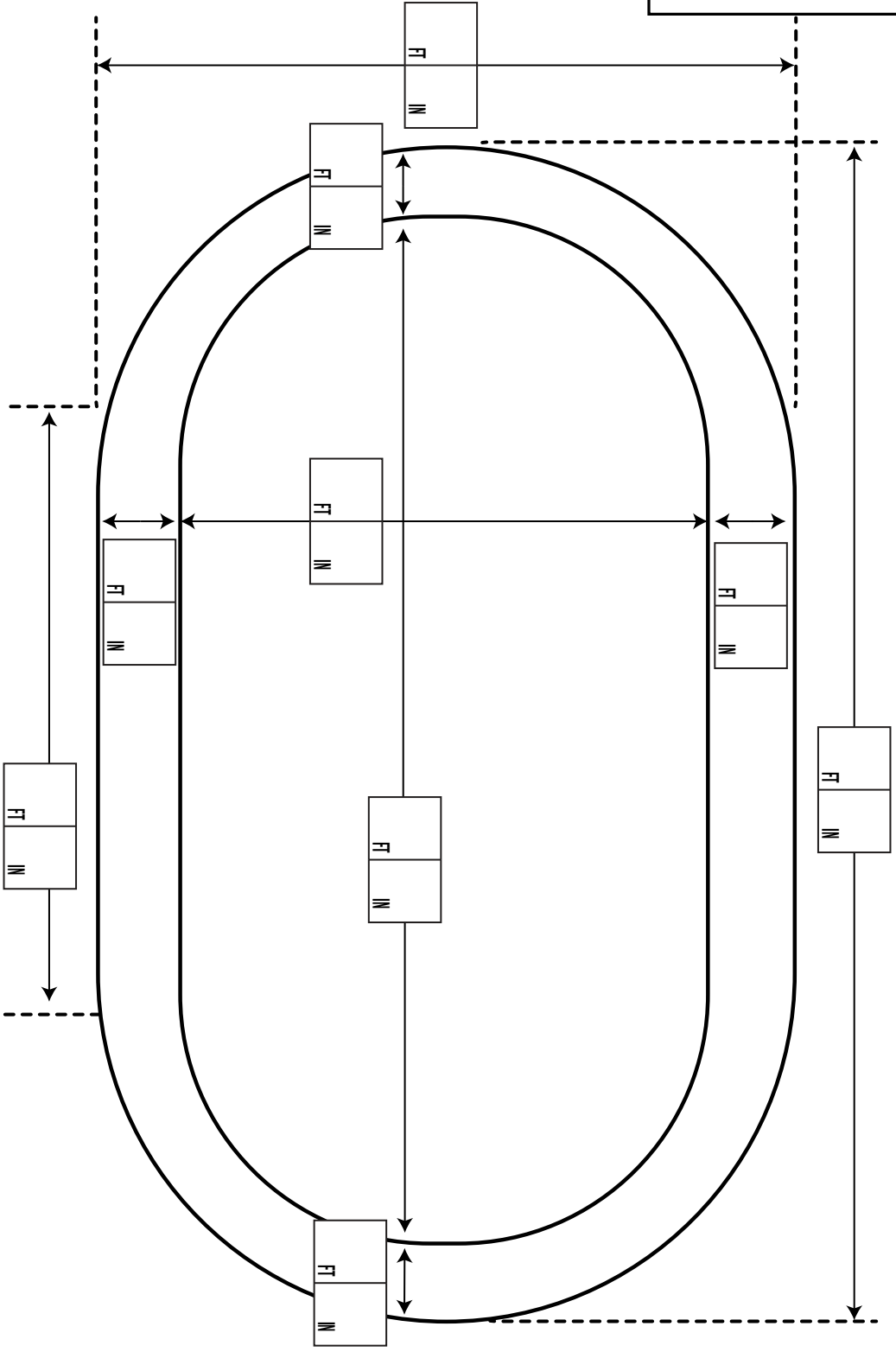

OVAL - OVAL HOPPER



CUSTOMER TAG NAME: _____

ORDER INFORMATION

QUOTE #: _____ SO#: _____

PO#: _____

FIBERGLASS STEPS

YES

STRAIGHT RADIUS

LOCATION: CENTER SHALLOW END OTHER (DRAW IN LOCATION)

VINYL COVERED STEPS

YES --> NOTE: STEP MEASURING FORM REQUIRED

LOCATION: CENTER SHALLOW END OTHER (DRAW IN LOCATION)

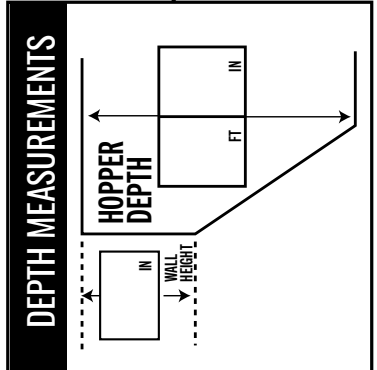

ALL LENGTH MEASUREMENTS MUST ADD UP TO THIS NUMBER.

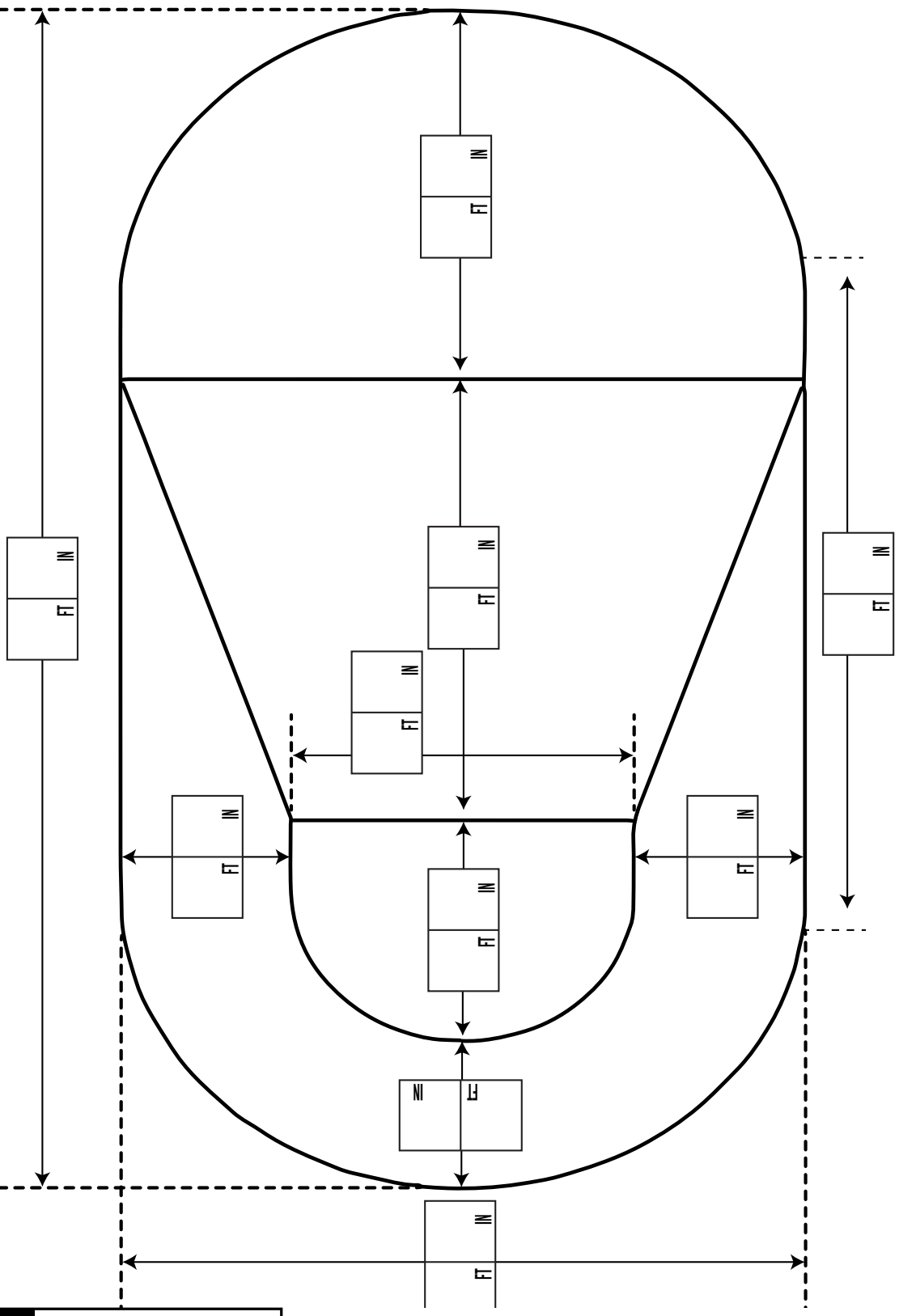

ALL WIDTH MEASUREMENTS MUST ADD UP TO THIS NUMBER.

OVAL - SAFETY LEDGE

CUSTOMER TAG NAME:

FIBERGLASS STEPS

VINYL COVERED STEPS

ORDER INFORMATION

YES --> STRAIGHT RADIUS

YES --> NOTE: STEP MEASURING FORM REQUIRED

LOCATION: CENTER SHALLOW END OTHER (DRAW IN LOCATION)

LOCATION: CENTER SHALLOW END OTHER (DRAW IN LOCATION)

QUOTE #: _____ SO#: _____

PO#: _____

DEPTH MEASUREMENTS

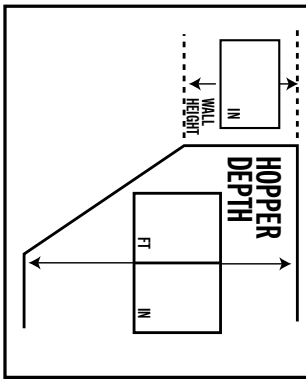

ALL WIDTH MEASUREMENTS MUST ADD UP TO THIS NUMBER.

ALL LENGTH MEASUREMENTS MUST ADD UP TO THIS NUMBER.

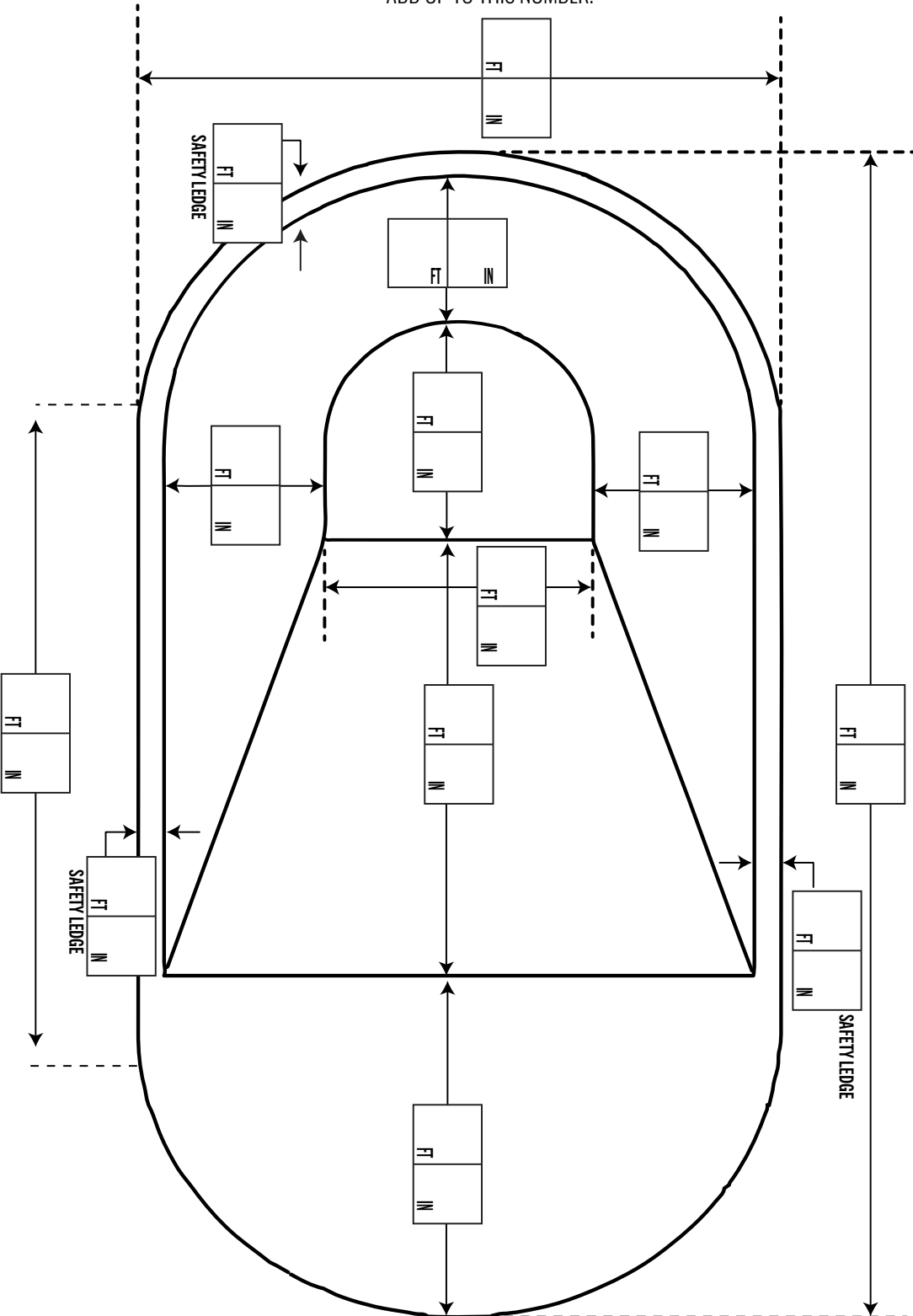



DOUBLE ROMAN - OVAL HOPPER

CUSTOMER TAG NAME:

ORDER INFORMATION

QUOTE #: _____ SO#: _____

PO#: _____

FIBERGLASS STEPS

YES

STRAIGHT RADIUS

LOCATION: CENTER SHALLOW END OTHER (DRAW IN LOCATION)

VINYL COVERED STEPS

YES --> NOTE: STEP MEASURING FORM REQUIRED

LOCATION: CENTER SHALLOW END OTHER (DRAW IN LOCATION)

DEPTH MEASUREMENTS

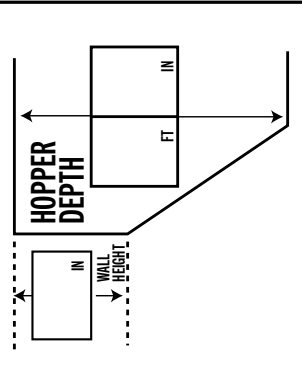

CORNER SIZE & SHAPE

SQUARE

RADIUS

DIAGONAL

ALL LENGTH MEASUREMENTS MUST ADD UP TO THIS NUMBER.

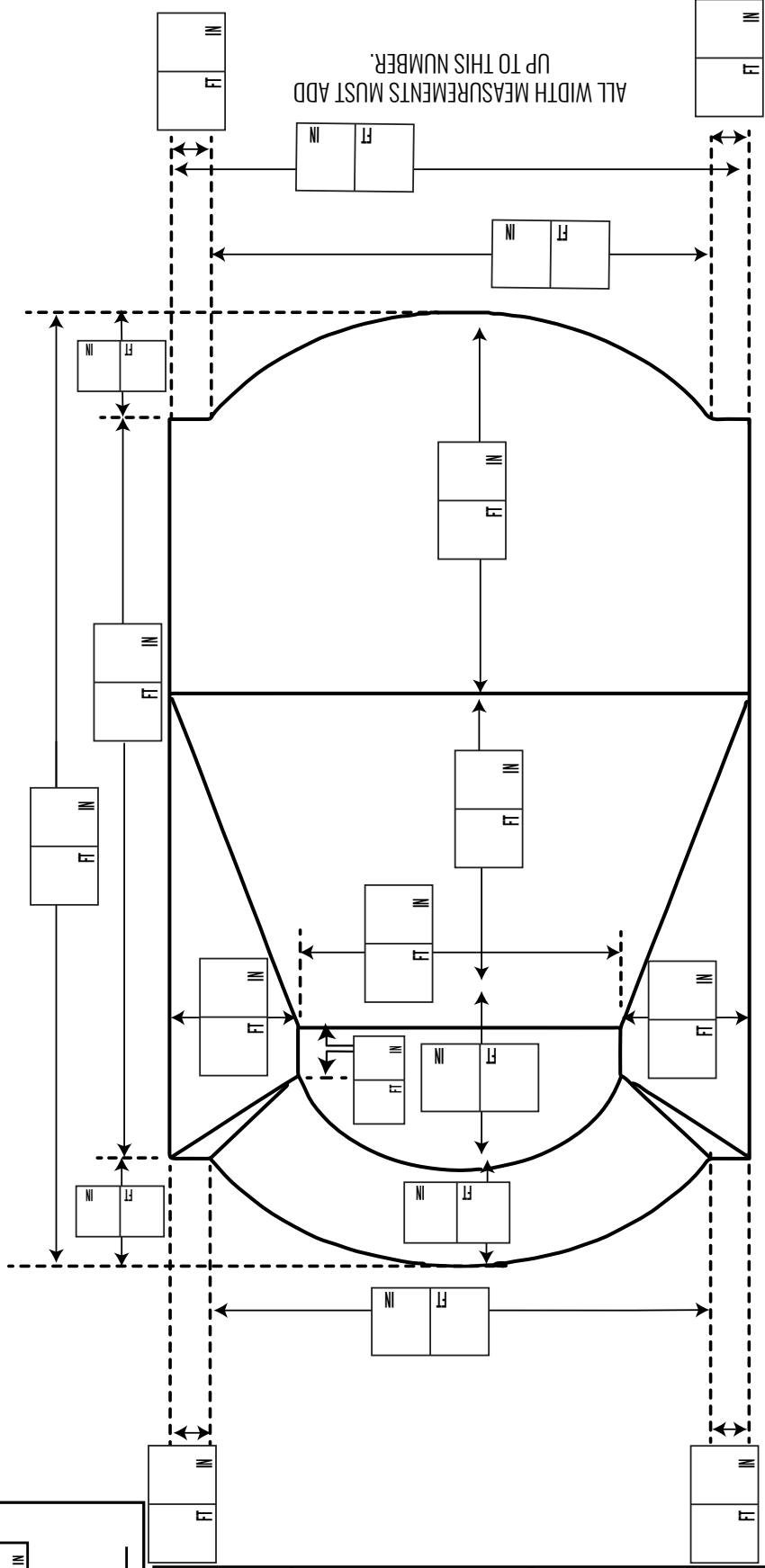

SINGLE ROMAN - OVAL HOPPER

CUSTOMER TAG NAME:

ORDER INFORMATION

QUOTE #: _____ SQ#: _____

PO#: _____

FIBERGLASS STEPS

YES --> STRAIGHT RADIUS
 LOCATION CENTER SHALLOW END OTHER (DRAW IN LOCATION)

VINYL COVERED STEPS

YES --> NOTE: STEP MEASURING FORM REQUIRED
 LOCATION: CENTER SHALLOW END OTHER (DRAW IN LOCATION)

DEPTH MEASUREMENTS

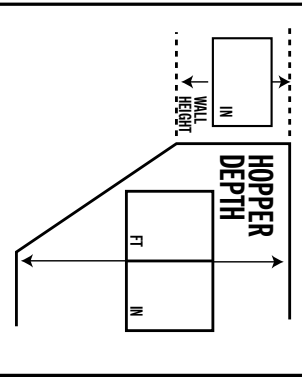

HOPPER PAD CORNERS

SQUARE
 RADIUS _____ IN.

ALL LENGTH MEASUREMENTS MUST ADD UP TO THIS NUMBER.

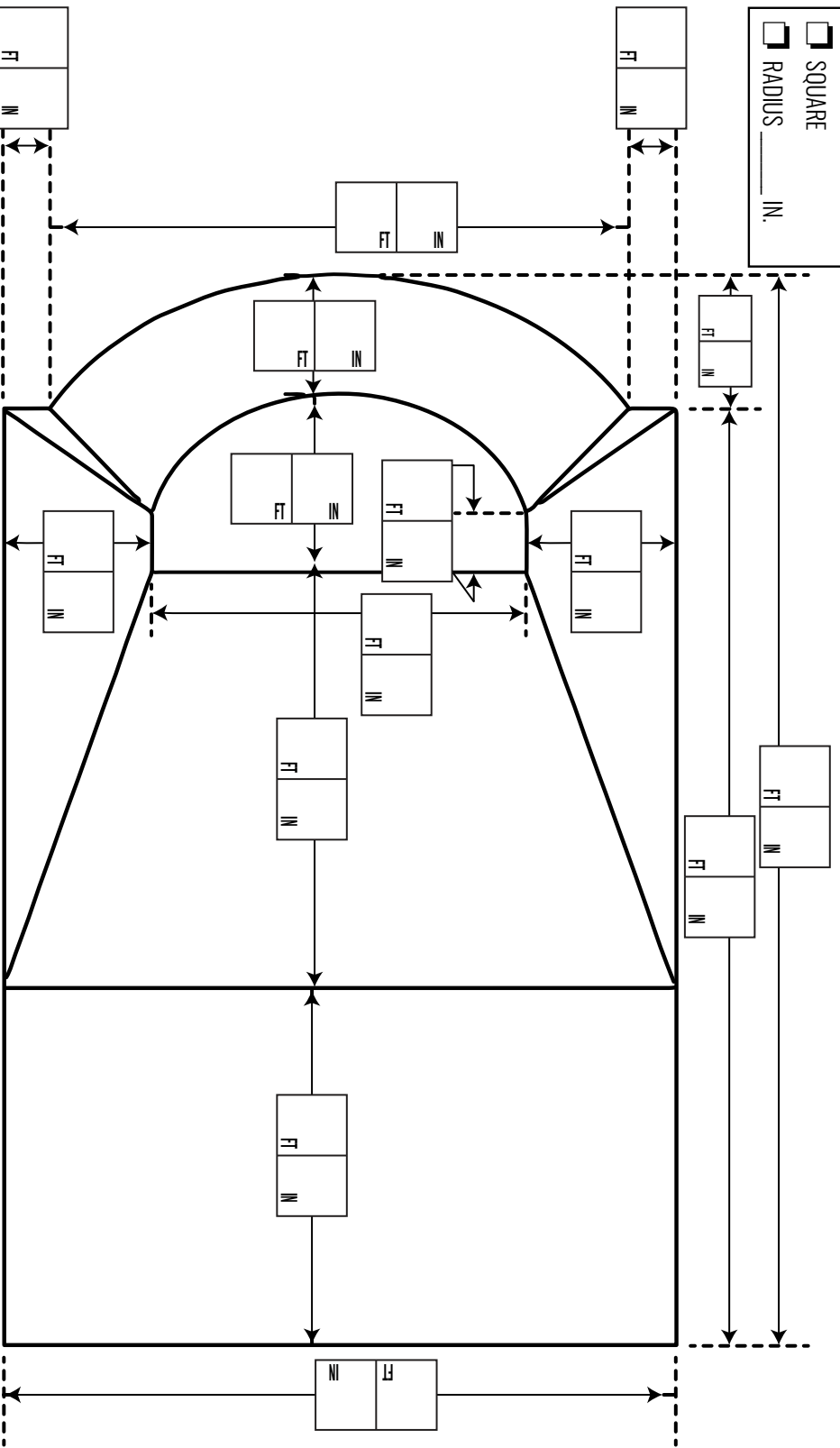

ALL WIDTH MEASUREMENTS MUST ADD UP TO THIS NUMBER.

CORNER SIZE & SHAPE

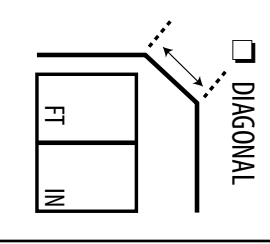
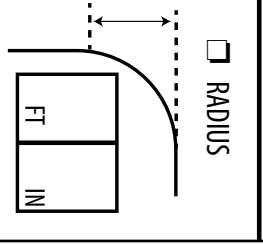



3 TREAD RECTANGLE STEP

CUSTOMER TAG NAME:

ORDER INFORMATION

QUOTE #:

SO#:

PO#:

STEP ATTACHMENT

- NONE
- ROD POCKETS
- BEADING
IS BEAD REQUIRED ON SIDES OF TOP TREAD?
 YES NO

MATERIAL

- SAME AS FLOOR
- SURE-STEP TEXTURE

LOCATION

- CENTER END SHALLOW
- OTHER (DRAW LOCATION)

TOP VIEW - 3 TREAD RECTANGLE STEP

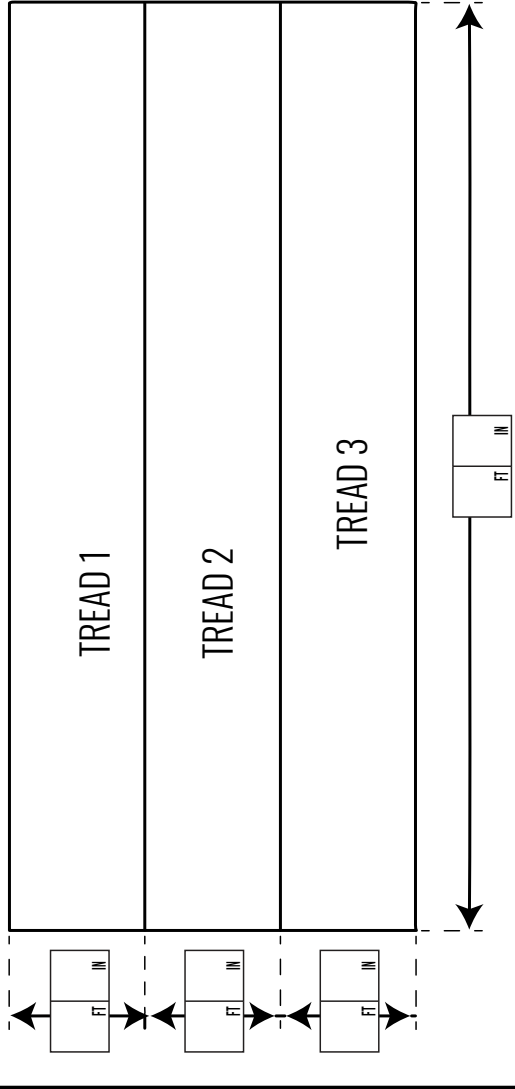

STEP CORNER SIZE & SHAPE

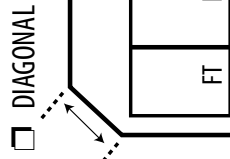
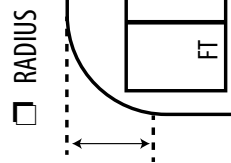
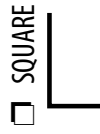

STRAIGHT SETBACK

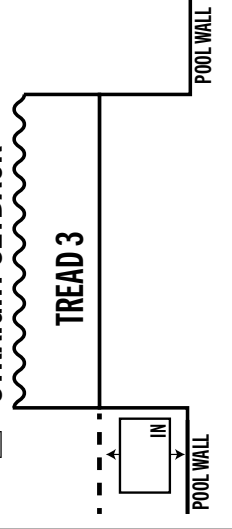

ANGLED SETBACK

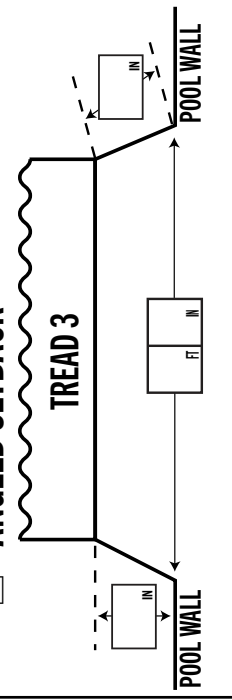

SIDE VIEW RISERS

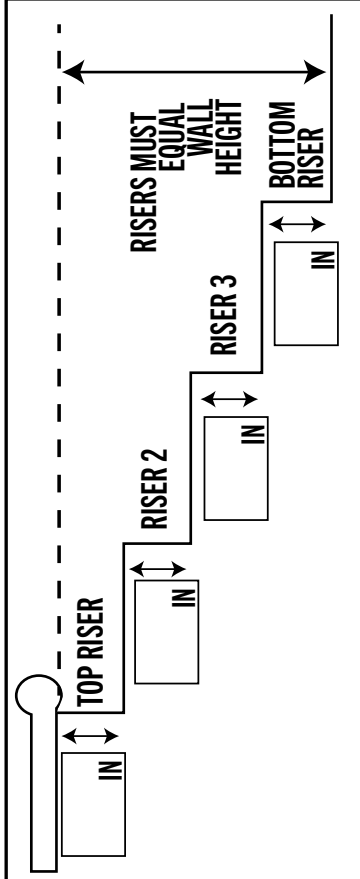

4 TREAD RECTANGLE STEP

CUSTOMER TAG NAME:

ORDER INFORMATION

QUOTE #: SO#:

PO#:

STEP ATTACHMENT

- NONE
- ROD POCKETS
- BEADING

MATERIAL

- SAME AS FLOOR
- SURE-STEP TEXTURE

LOCATION

- CENTER END SHALLOW
- OTHER (DRAW LOCATION)

TOP VIEW - 4 TREAD RECTANGLE STEP

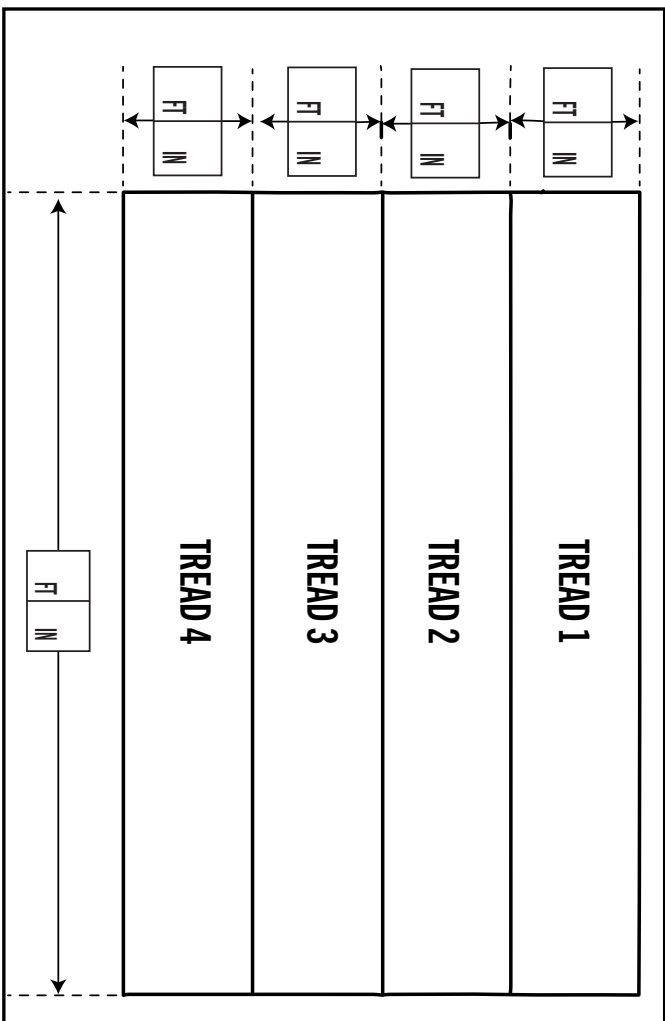

STEP CORNER SIZE & SHAPE

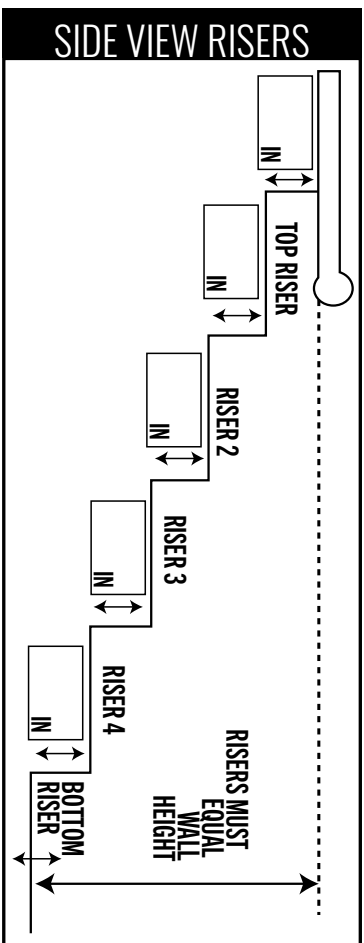
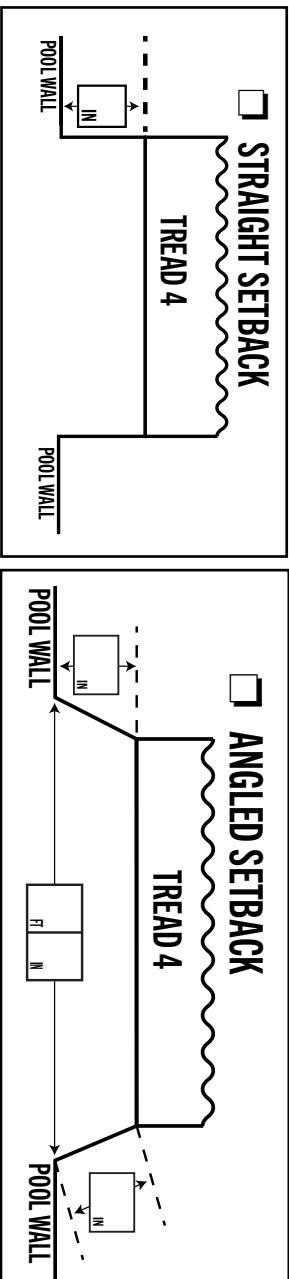
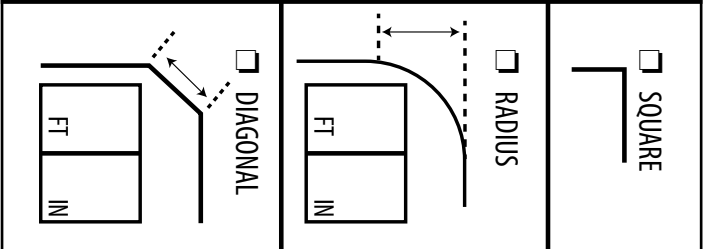



CORNER CAKE STEP

CUSTOMER TAG NAME:

ORDER INFORMATION

QUOTE #:

SO#:

PO#:

STEP ATTACHMENT

NONE

ROD POCKETS

BEADING

MATERIAL

SAME AS FLOOR

SURE-STEP TEXTURE

LOCATION

DRAW LOCATION ON POOL VIEW FORM

OTHER (DRAW LOCATION)

TOP VIEW - CORNER CAKE STEP

HOW WAS TOP TREAD MEASURED?

TO IMAGINARY SQUARED OFF CORNER

TO FACE OF RADIUS OR DIAGONAL CUT CORNER

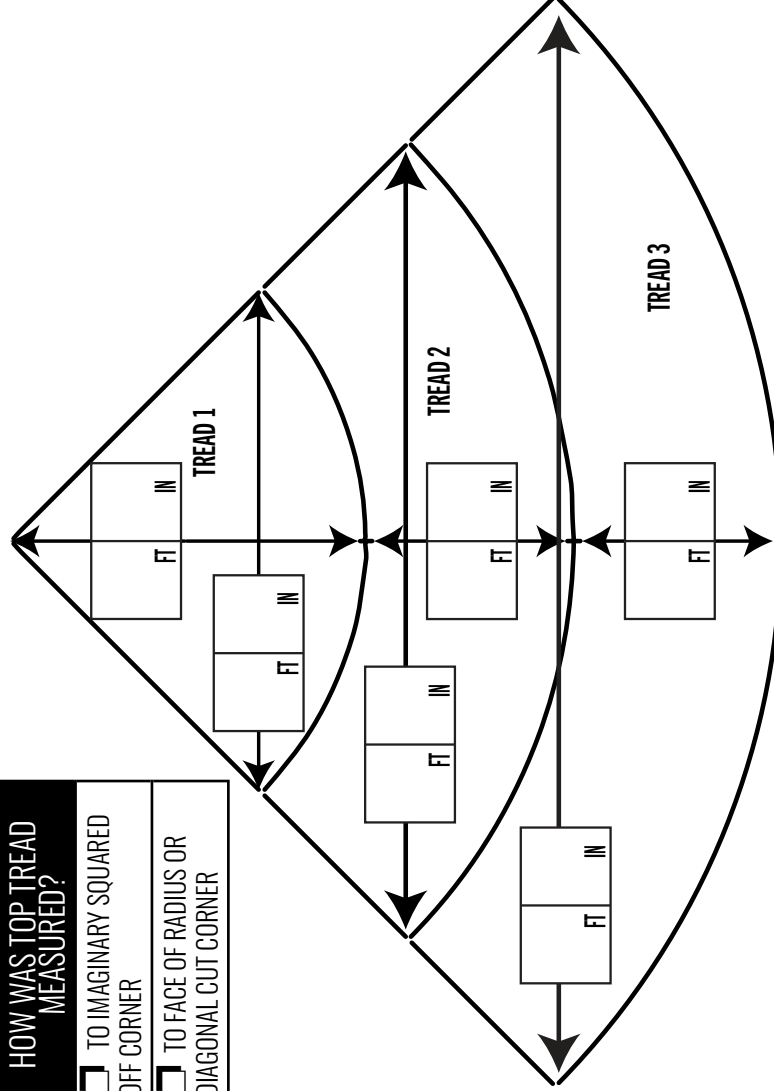

STEP CORNER SIZE & SHAPE

SQUARE

RADIUS

DIAGONAL

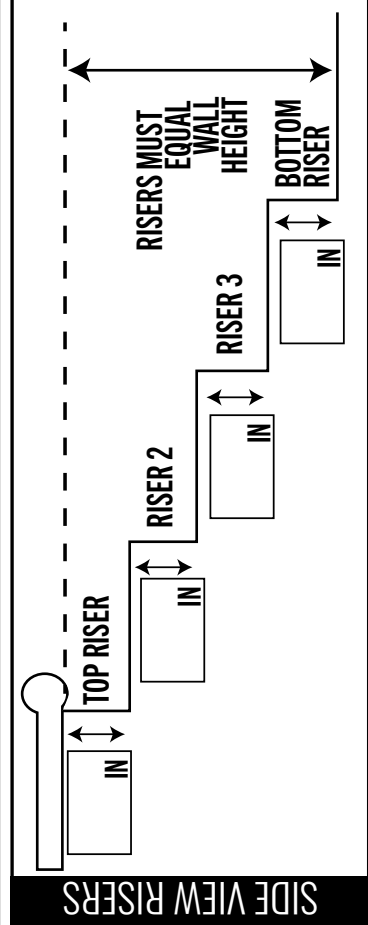

CUSTOMER TAG NAME:

ORDER INFORMATION

QUOTE #: _____ SO#: _____

PO#:

STEP ATTACHMENT

- NONE
- ROD POCKETS
- BEADING

MATERIAL

- SAME AS FLOOR
- SURE-STEP TEXTURE

LOCATION

- CENTER END SHALLOW
- OTHER (DRAW LOCATION)

TOP VIEW - BOWED STEP

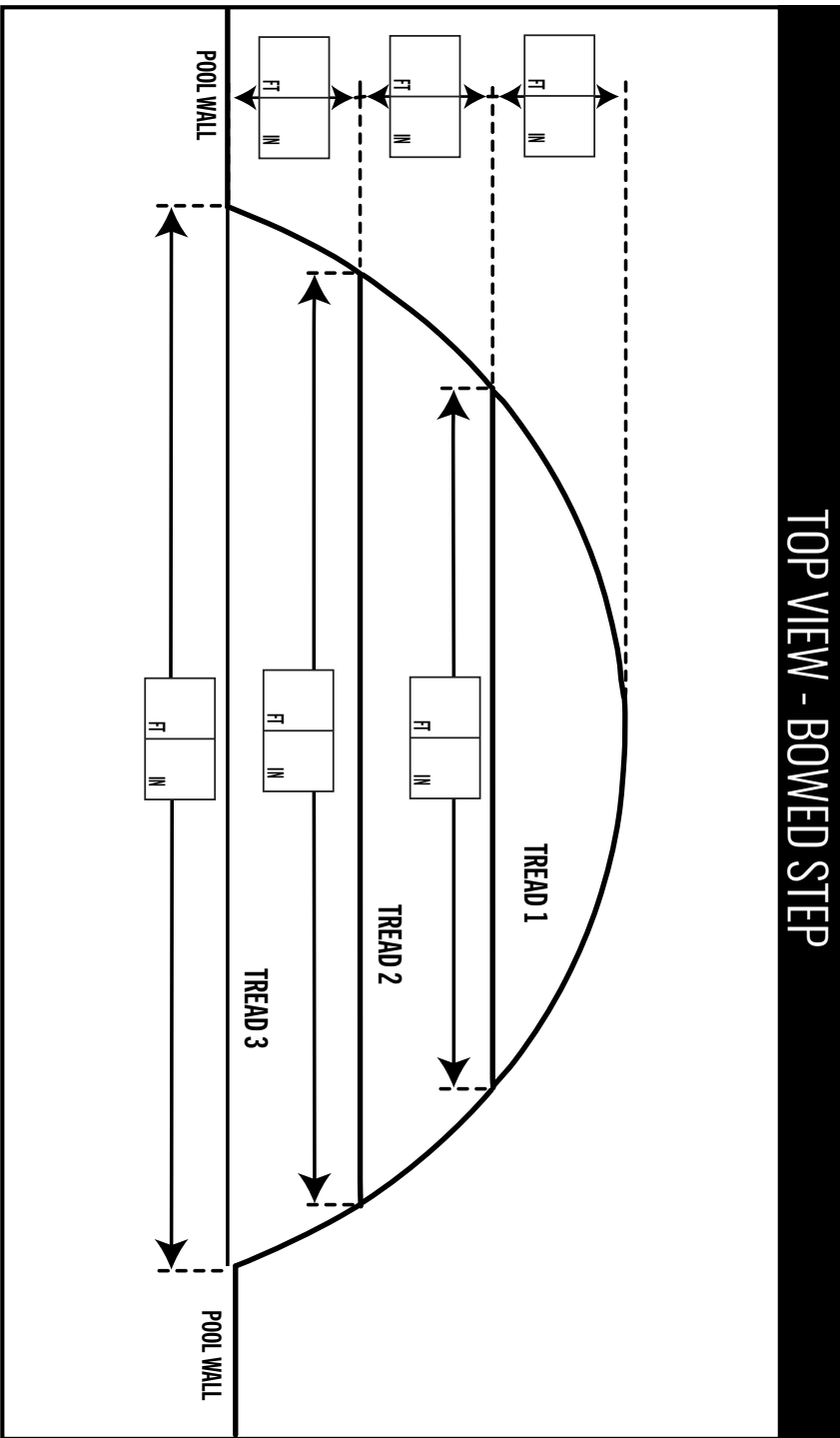

ANGLED SETBACK

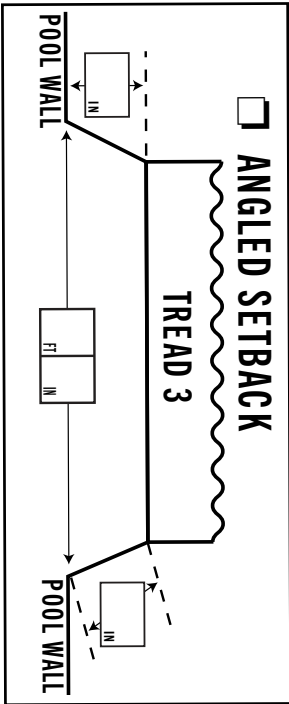

SIDE VIEW RISERS

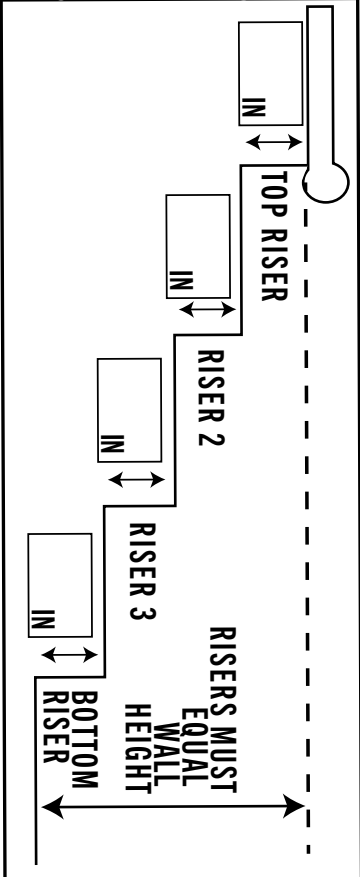



CORNER STEP

CUSTOMER TAG NAME:

ORDER INFORMATION

QUOTE #:

SO#:

PO#:

STEP ATTACHMENT

- NONE
- ROD POCKETS
- BEADING

MATERIAL

- SAME AS FLOOR
- SURE-STEP TEXTURE

LOCATION

- DRAW LOCATION ON POOL VIEW FORM

STEP CORNER SIZE & SHAPE

SQUARE

RADIUS

DIAGONAL

TOP VIEW - CORNER STEP

HOW WAS TOP TREAD MEASURED?

- TO IMAGINARY SQUARED OFF CORNER
- TO FACE OF RADIUS OR DIAGONAL CUT CORNER

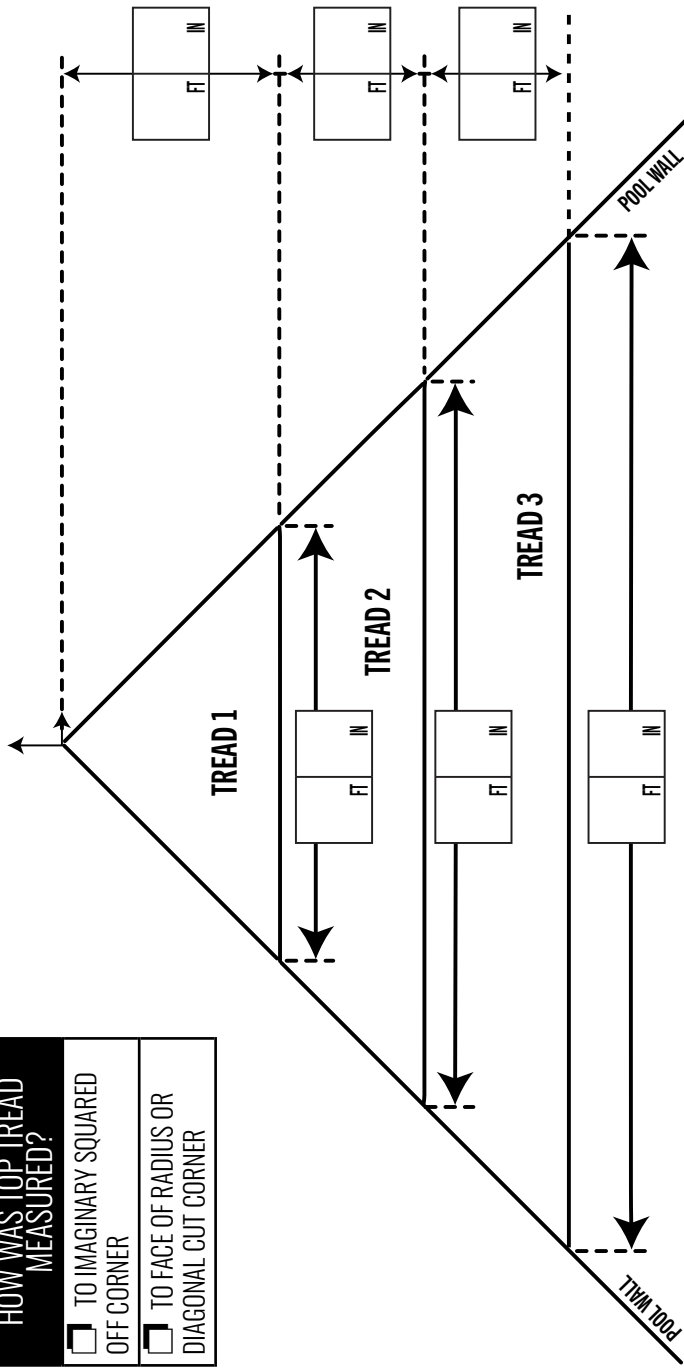

SIDE VIEW RISERS

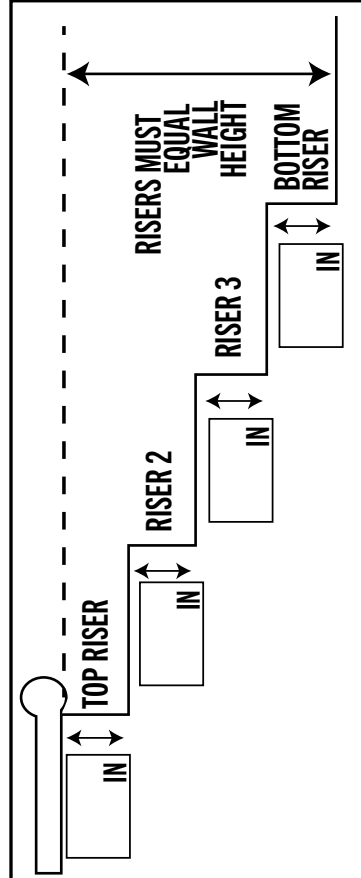

CUSTOMER TAG NAME:

ORDER INFORMATION

QUOTE #: _____ SO#: _____

PO#: _____

STEP ATTACHMENT

- NONE
- ROD POCKETS
- BEADING

MATERIAL

- SAME AS FLOOR
- SURE-STEP TEXTURE

LOCATION

- CENTER END SHALLOW
- OTHER (DRAW LOCATION)

TOP VIEW - FULL CAKE STEP

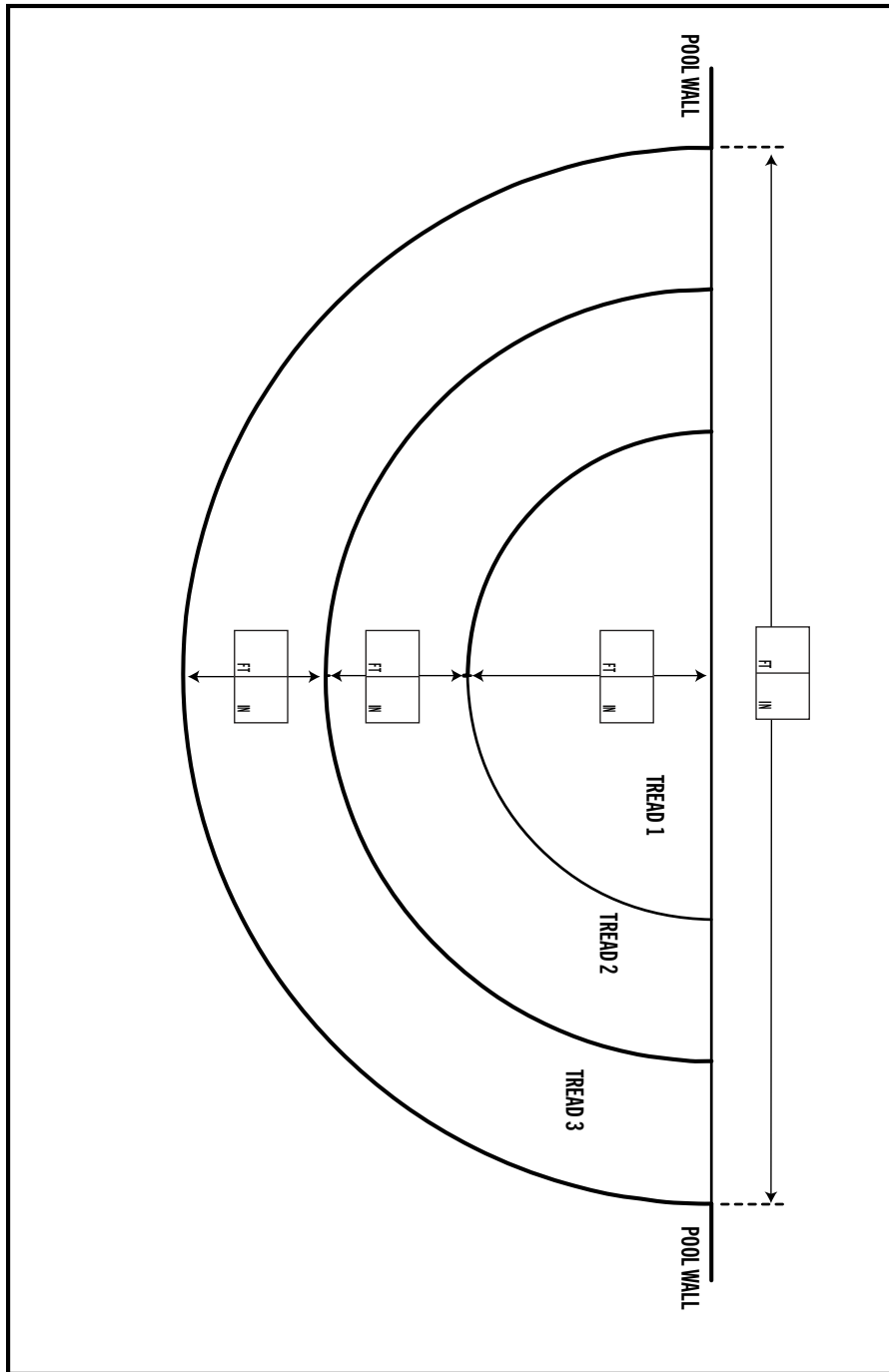

SIDE VIEW RISERS

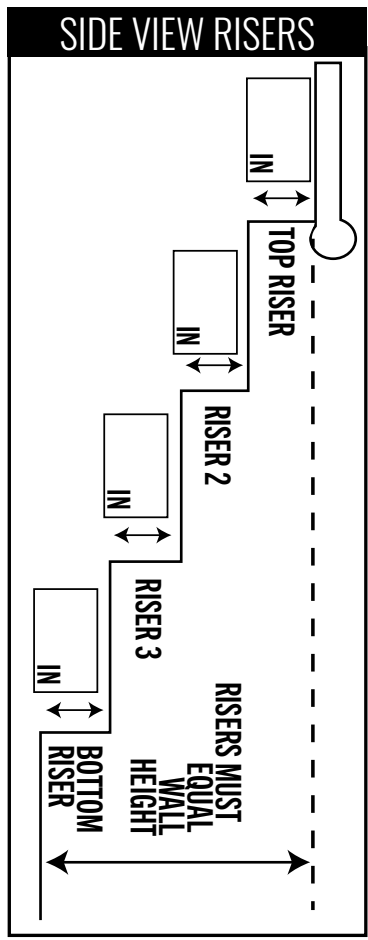



BENCH

CUSTOMER TAG NAME:

TOP VIEW - BENCH

ORDER INFORMATION

QUOTE #:

SO#:

PO#:

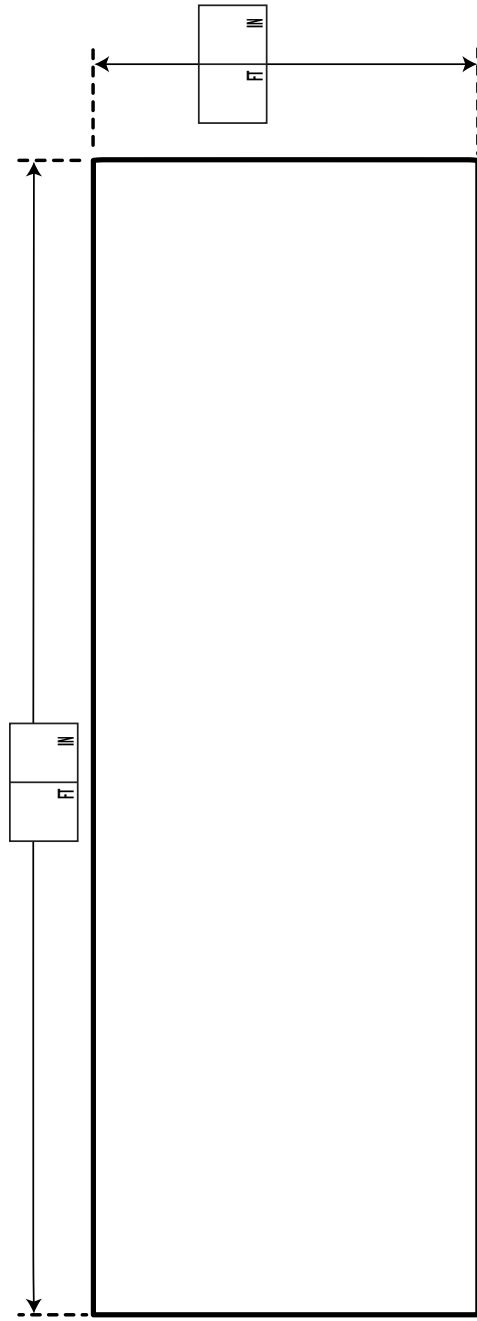

BENCH ATTACHMENT

NONE

ROD POCKETS

BEADING

MATERIAL

SAME AS FLOOR

SURE-STEP TEXTURE

LOCATION

DRAW LOCATION ON SHAPE PAGE

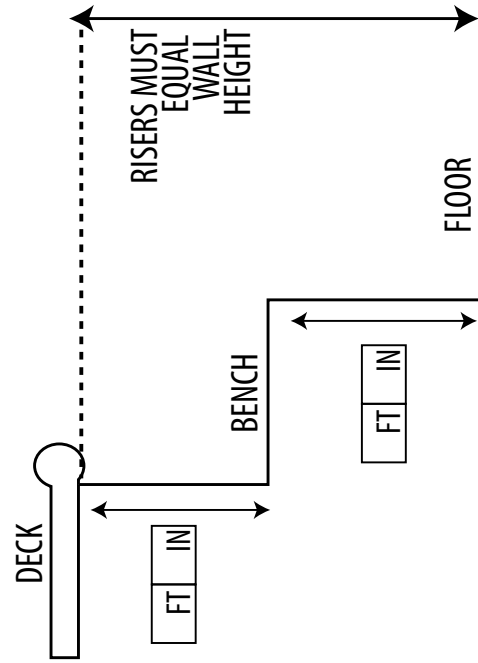

SIDE VIEW - BENCH RISER

STEP CORNER SIZE & SHAPE

SQUARE

RADIUS

DIAGONAL

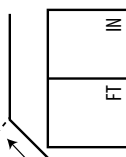
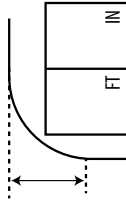

CUSTOM SHAPE

CUSTOMER TAG NAME:

ORDER INFORMATION

QUOTE #: _____ SQ#: _____

PO#:

FIBERGLASS STEPS

YES --> STRAIGHT RADIUS _____
 LOCATION CENTER SHALLOW END OTHER (DRAW IN LOCATION)

VINYL COVERED STEPS

YES --> NOTE: STEP MEASURING FORM REQUIRED
 LOCATION: CENTER SHALLOW END OTHER (DRAW IN LOCATION)

DEPTH MEASUREMENTS

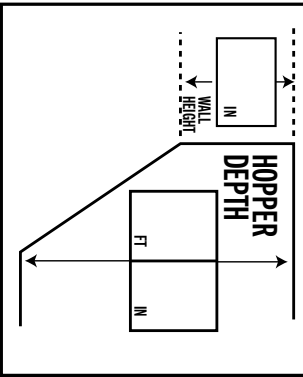

HOPPER PAD CORNERS

SQUARE
 RADIUS _____ IN.

CORNER SIZE & SHAPE

SQUARE

RADIUS

DIAGONAL

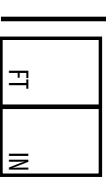

POOL DRAWING

IMPORTANT! INCLUDE AB LINE IN YOUR SKETCH BELOW.

DISTANCE OF POINT A TO POINT B: _____
 PROVIDE A - B FORM.



CUSTOM SHAPE MEASURING FORM

ORDER INFORMATION

QUOTE#:	PO#:
SO#:	

CUSTOMER TAG NAME:

--

AB POINTS

A		B		A		B		A		B	
FT	IN	FT	IN	FT	IN	FT	IN	FT	IN	FT	IN
1				31				61			
2				32				62			
3				33				63			
4				34				64			
5				35				65			
6				36				66			
7				37				67			
8				38				68			
9				39				69			
10				40				70			
11				41				71			
12				42				72			
13				43				73			
14				44				74			
15				45				75			
16				46				76			
17				47				77			
18				48				78			
19				49				79			
20				50				80			
21				51				81			
22				52				82			
23				53				83			
24				54				84			
25				55				85			
26				56				86			
27				57				87			
28				58				88			
29				59				89			
30				60				90			

SHALLOW BREAK POINTS

PT # ___ TO PT # ___

DEEP BREAK POINTS

PT # ___ TO PT # ___

FIBERGLASS STEP

PT # ___ TO PT # ___

STRAIGHT RADIUS

VINYL COVERED STEP

PT # ___ TO PT # ___

Note: Provide correct step measuring form.

TRANSITION SLOPE MEASUREMENTS

MEASURE PERPENDICULAR TO SIDE WALL

*SEE DIAGRAM 1 BELOW	DISTANCE OUT
PT # _____	_____ IN.
PT # _____	_____ IN.
PT # _____	_____ IN.
PT # _____	_____ IN.

DIAGRAM 1

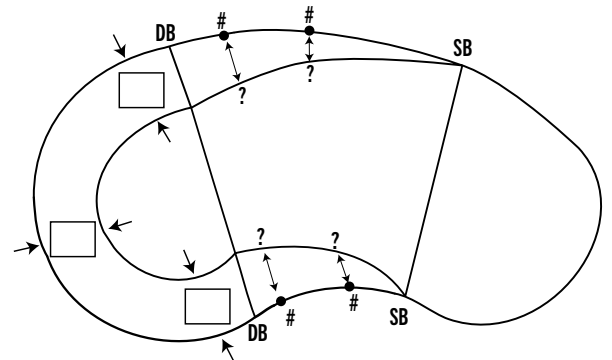

	FT	IN
DISTANCE FROM "A" TO "B"		

FT IN

	FT	IN	From PT #	TO PT #
Overall Length				
Overall Width				
Optional 2nd Overall Length				
Optional 2nd Overall Width				

COMMENTS / SPECIAL NOTES:

--



**COMPLETED FORMS CAN BE FAXED TO 866-298-0173
OR EMAILED TO CUSTOMFORMS@INTHESWIM.COM**

-- These forms are downloadable via the below website --
WWW.INTHESWIM.COM/IGFORMS

